

**CoolMOS™ Power Transistor**
**Features**

- Intrinsic fast-recovery body diode
- Extremely low reverse recovery charge
- Ultra low gate charge
- Extreme  $dv/dt$  rated
- High peak current capability
- Qualified according to JEDEC<sup>1)</sup> for target applications

**CoolMOS CFD designed for:**

- Softswitching PWM Stages
- LCD & CRT TV

**Product Summary**

$V_{DS} @ T_{jmax}$	650	V
$R_{DS(on),max}$	0.330	$\Omega$
$I_D$	13.4	A

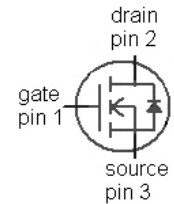
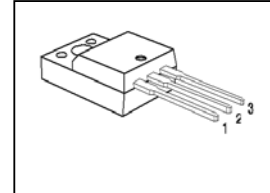
**PG-TO220FP**

Type	Package	Marking
SPA15N60CFD	PG-TO220FP	15N60CFD

**Maximum ratings, at  $T_j=25\text{ }^\circ\text{C}$ , unless otherwise specified**

Parameter	Symbol	Conditions	Value	Unit
Continuous drain current <sup>2)</sup>	$I_D$	$T_C=25\text{ }^\circ\text{C}$	13.4	A
		$T_C=100\text{ }^\circ\text{C}$	8.4	
Pulsed drain current <sup>3)</sup>	$I_{D,pulse}$	$T_C=25\text{ }^\circ\text{C}$	33	
Avalanche energy, single pulse	$E_{AS}$	$I_D=6.7\text{ A}$ , $V_{DD}=50\text{ V}$	460	mJ
Avalanche energy, repetitive <sup>3),4)</sup>	$E_{AR}$	$I_D=13.4\text{ A}$ , $V_{DD}=50\text{ V}$	0.8	
Avalanche current, repetitive <sup>3),4)</sup>	$I_{AR}$		13.4	A
Drain source voltage slope	$dv/dt$	$I_D=13.4\text{ A}$ , $V_{DS}=480\text{ V}$ , $T_j=125\text{ }^\circ\text{C}$	80	V/ns
Reverse diode $dv/dt$	$dv/dt$	$I_S=13.4\text{ A}$ , $V_{DS}=480\text{ V}$ ,	40	V/ns
Maximum diode commutation speed	$di/dt$	$T_j=125\text{ }^\circ\text{C}$	600	
Gate source voltage	$V_{GS}$	static	$\pm 20$	V
		AC ( $f > 1\text{ Hz}$ )	$\pm 30$	
Power dissipation	$P_{tot}$	$T_C=25\text{ }^\circ\text{C}$	34	W
Operating and storage temperature	$T_j, T_{stg}$		-55 ... 150	$^\circ\text{C}$
Mounting torque		M2.5 screws	50	Ncm

Parameter	Symbol	Conditions	Values			Unit
			min.	typ.	max.	

**Thermal characteristics**

Thermal resistance, junction - case	$R_{thJC}$		-	-	3.7	K/W
Thermal resistance, junction - ambient	$R_{thJA}$	leaded	-	-	62	
Soldering temperature, wave soldering only allowed at leads	$T_{sold}$	1.6 mm (0.063 in.) from case for 10 s	-	-	260	°C

**Electrical characteristics, at  $T_j=25\text{ }^\circ\text{C}$ , unless otherwise specified**
**Static characteristics**

Drain-source breakdown voltage	$V_{(BR)DSS}$	$V_{GS}=0\text{ V}, I_D=250\text{ }\mu\text{A}$	600	-	-	V
Avalanche breakdown voltage	$V_{(BR)DS}$	$V_{GS}=0\text{ V}, I_D=13.4\text{ A}$	-	700	-	
Gate threshold voltage	$V_{GS(th)}$	$V_{DS}=V_{GS}, I_D=750\text{ }\mu\text{A}$	3	4	5	
Zero gate voltage drain current	$I_{DSS}$	$V_{DS}=600\text{ V}, V_{GS}=0\text{ V}, T_j=25\text{ }^\circ\text{C}$	-	1.4	-	$\mu\text{A}$
		$V_{DS}=600\text{ V}, V_{GS}=0\text{ V}, T_j=150\text{ }^\circ\text{C}$	-	1200	-	
Gate-source leakage current	$I_{GSS}$	$V_{GS}=20\text{ V}, V_{DS}=0\text{ V}$	-	-	100	nA
Drain-source on-state resistance	$R_{DS(on)}$	$V_{GS}=10\text{ V}, I_D=9.4\text{ A}, T_j=25\text{ }^\circ\text{C}$	-	0.28	0.33	$\Omega$
		$V_{GS}=10\text{ V}, I_D=9.4\text{ A}, T_j=150\text{ }^\circ\text{C}$	-	0.78	-	
Gate resistance	$R_G$	$f=1\text{ MHz}$ , open drain	-	1.3	-	
Transconductance	$g_{fs}$	$ V_{DS} >2 I_D R_{DS(on)max}, I_D=9.4\text{ A}$	-	8	-	S

Parameter	Symbol	Conditions	Values			Unit
			min.	typ.	max.	

**Dynamic characteristics**

Input capacitance	$C_{iss}$	$V_{GS}=0\text{ V}, V_{DS}=25\text{ V},$ $f=1\text{ MHz}$	-	1820	-	pF
Output capacitance	$C_{oss}$		-	520	-	
Reverse transfer capacitance	$C_{rss}$		-	21	-	
Effective output capacitance, energy related <sup>5)</sup>	$C_{o(er)}$	$V_{GS}=0\text{ V}, V_{DS}=0\text{ V}$ to 480 V	-	61	-	
Effective output capacitance, time related <sup>6)</sup>	$C_{o(tr)}$		-	110	-	
Turn-on delay time	$t_{d(on)}$	$V_{DD}=400\text{ V},$ $V_{GS}=10\text{ V}, I_D=13.4\text{ A},$ $R_G=3.6\ \Omega$	-	43	-	ns
Rise time	$t_r$		-	24	-	
Turn-off delay time	$t_{d(off)}$		-	47	-	
Fall time	$t_f$		-	5	-	

**Gate Charge Characteristics**

Gate to source charge	$Q_{gs}$	$V_{DD}=480\text{ V},$ $I_D=13.4\text{ A},$ $V_{GS}=0\text{ to }10\text{ V}$	-	11	-	nC
Gate to drain charge	$Q_{gd}$		-	38	-	
Gate charge total	$Q_g$		-	63	84	
Gate plateau voltage	$V_{plateau}$		-	7.3	-	V

<sup>1)</sup> J-STD20 and JESD22

<sup>2)</sup> Limited only by maximum temperature

<sup>3)</sup> Pulse width  $t_p$  limited by  $T_{j,max}$

<sup>4)</sup> Repetitive avalanche causes additional power losses that can be calculated as  $P_{AV}=E_{AR} \cdot f$ .

<sup>5)</sup>  $C_{o(er)}$  is a fixed capacitance that gives the same stored energy as  $C_{oss}$  while  $V_{DS}$  is rising from 0 to 80%  $V_{DSS}$ .

<sup>6)</sup>  $C_{o(tr)}$  is a fixed capacitance that gives the same charging time as  $C_{oss}$  while  $V_{DS}$  is rising from 0 to 80%  $V_{DSS}$ .

Parameter	Symbol	Conditions	Values			Unit
			min.	typ.	max.	
<b>Reverse Diode</b>						
Diode continuous forward current <sup>2)</sup>	$I_S$	$T_C=25\text{ °C}$	-	-	13.4	A
Diode pulse current <sup>3)</sup>	$I_{S,pulse}$		-	-	33	
Diode forward voltage	$V_{SD}$	$V_{GS}=0\text{ V}, I_F=I_S,$ $T_j=25\text{ °C}$	-	1.0	1.2	V
Reverse recovery time	$t_{rr}$	$V_R=480\text{ V}, I_F=I_S,$ $di_F/dt=100\text{ A}/\mu\text{s}$	-	147	-	ns
Reverse recovery charge	$Q_{rr}$		-	1	-	$\mu\text{C}$
Peak reverse recovery current	$I_{rrm}$		-	12	-	A
Peak rate of fall of reverse recovery current	$di_{rr}/dt$	$T_j=25\text{ °C}$	-	1200	-	$\text{A}/\mu\text{s}$

**1 Power dissipation**

$$P_{tot} = f(T_C)$$

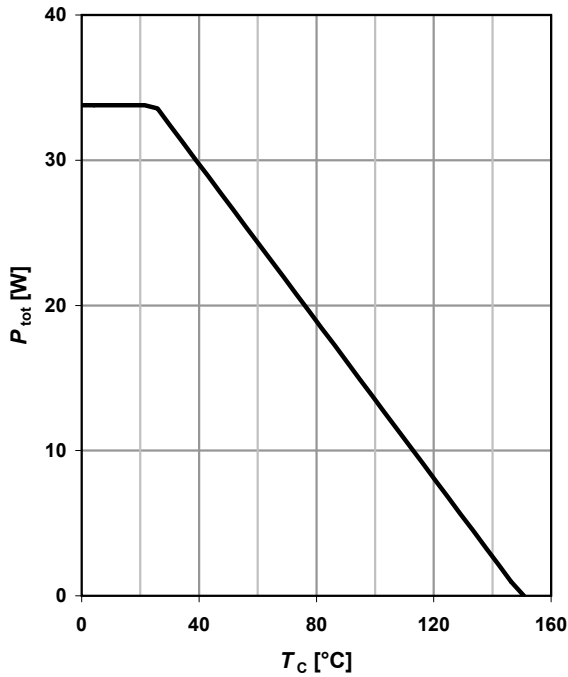

**2 Safe operating area**

$$I_D = f(V_{DS}); T_C = 25\text{ °C}; D = 0$$

parameter:  $t_p$

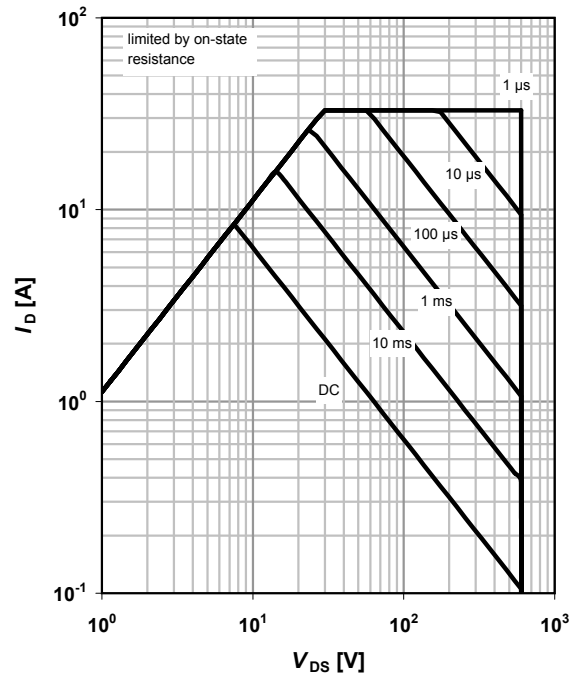

**3 Max. transient thermal impedance**

$$I_D = f(V_{DS}); T_J = 25\text{ °C}$$

parameter:  $D = t_p / T$

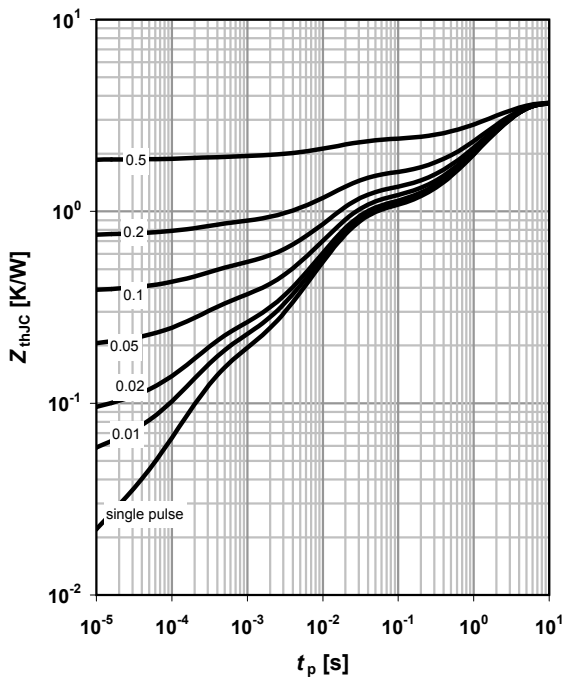

**4 Typ. output characteristics**

$$I_D = f(V_{DS}); T_J = 25\text{ °C}$$

parameter:  $V_{GS}$

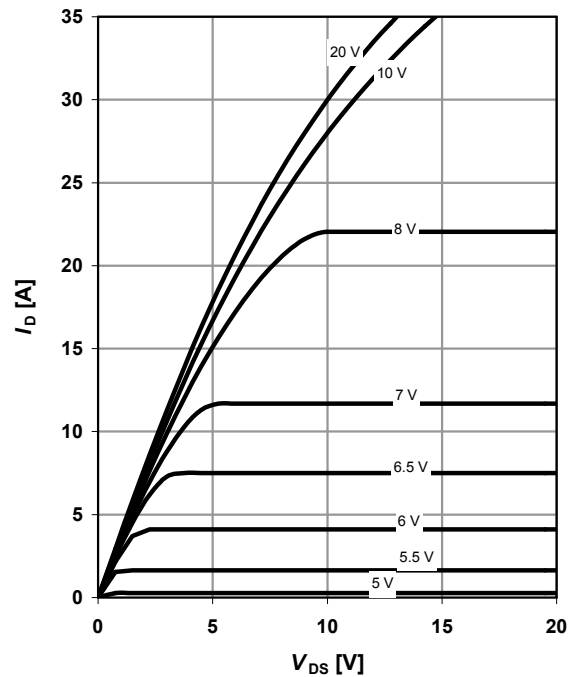

**5 Typ. output characteristics**

$I_D = f(V_{DS}); T_j = 150\text{ }^\circ\text{C}$

parameter:  $V_{GS}$

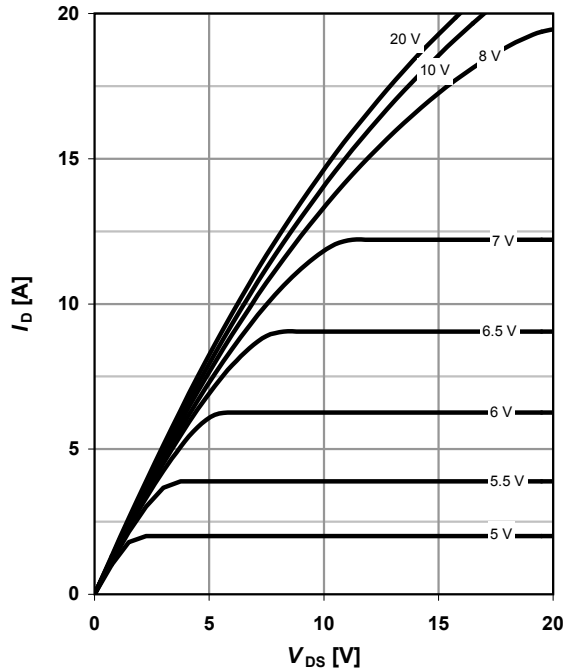

**6 Typ. drain-source on-state resistance**

$R_{DS(on)} = f(I_D); T_j = 150\text{ }^\circ\text{C}$

parameter:  $V_{GS}$

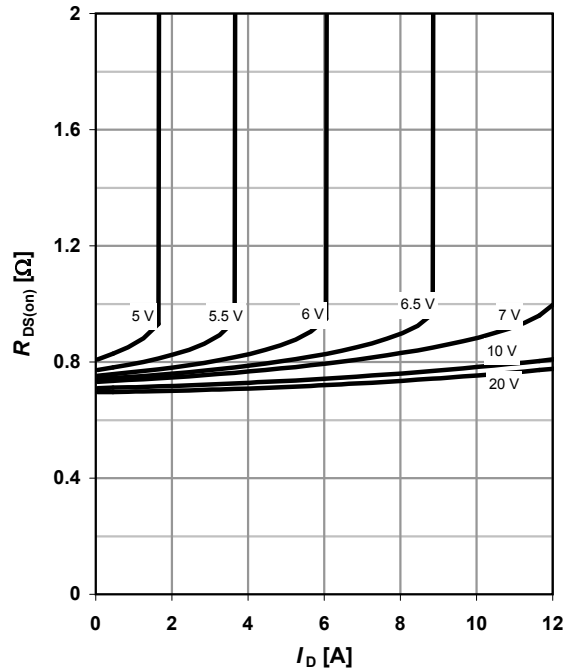

**7 Drain-source on-state resistance**

$R_{DS(on)} = f(T_j); I_D = 9.4\text{ A}; V_{GS} = 10\text{ V}$

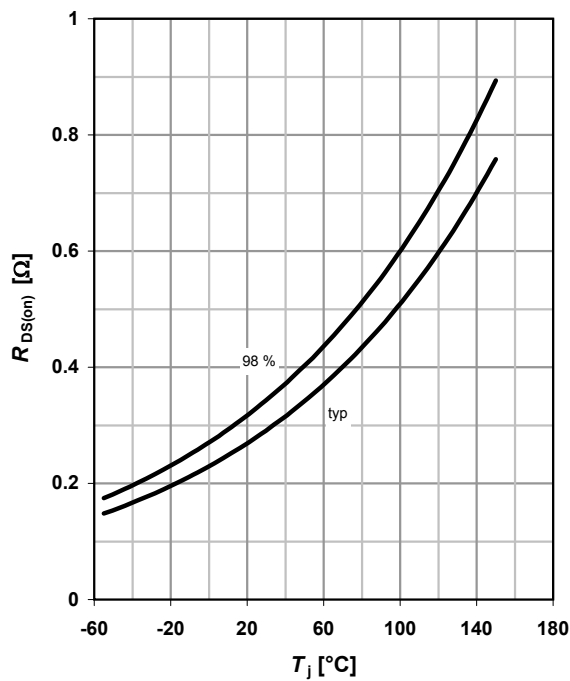

**8 Typ. transfer characteristics**

$I_D = f(V_{GS}); |V_{DS}| > 2 I_D / R_{DS(on)max}$

parameter:  $T_j$

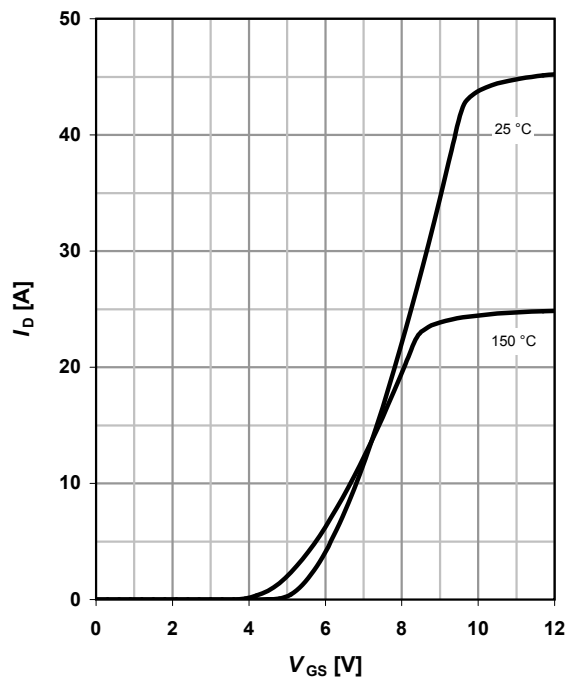

**9 Typ. gate charge**

$V_{GS}=f(Q_{gate}); I_D=13.4 \text{ A pulsed}$

parameter:  $V_{DD}$

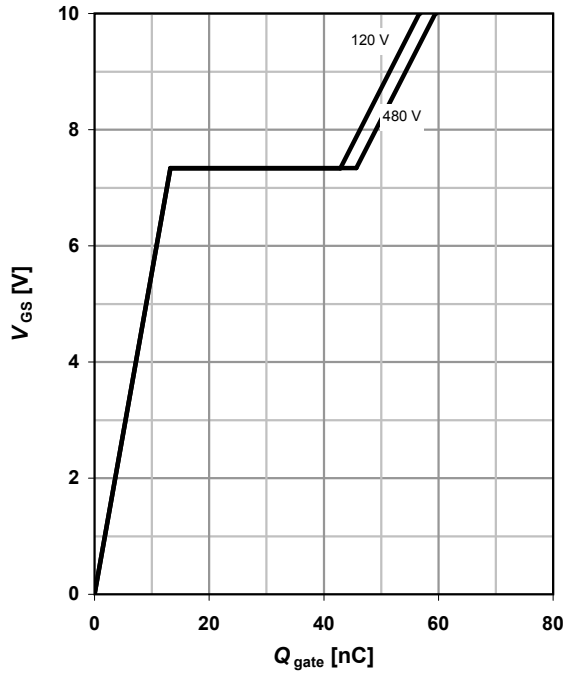

**10 Forward characteristics of reverse diode**

$I_F=f(V_{SD})$

parameter:  $T_j$

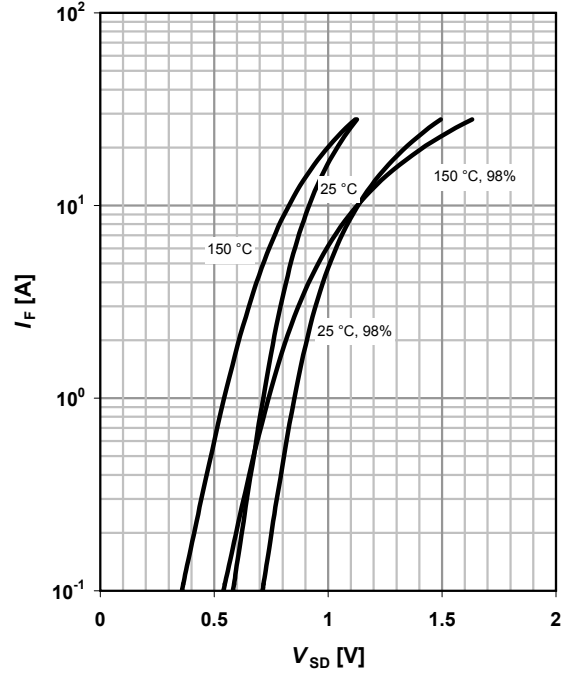

**11 Avalanche SOA**

$I_{AR}=f(t_{AR})$

parameter:  $T_{j(start)}$

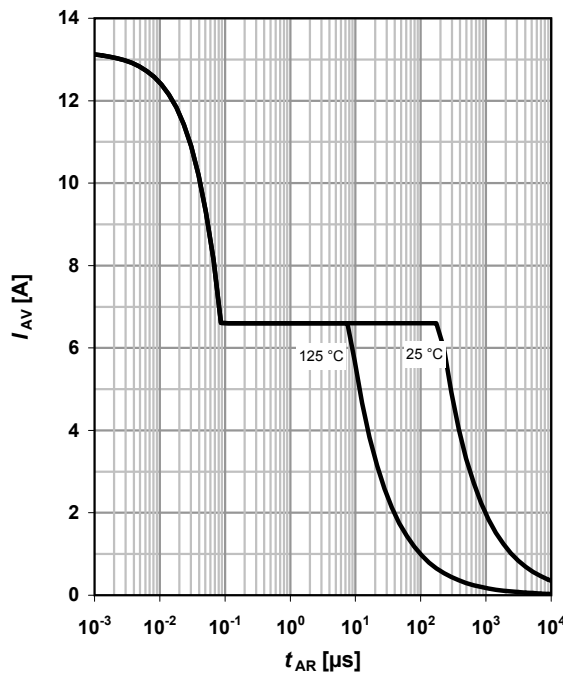

**12 Avalanche energy**

$E_{AS}=f(T_j); I_D=6.7 \text{ A}; V_{DD}=50 \text{ V}$

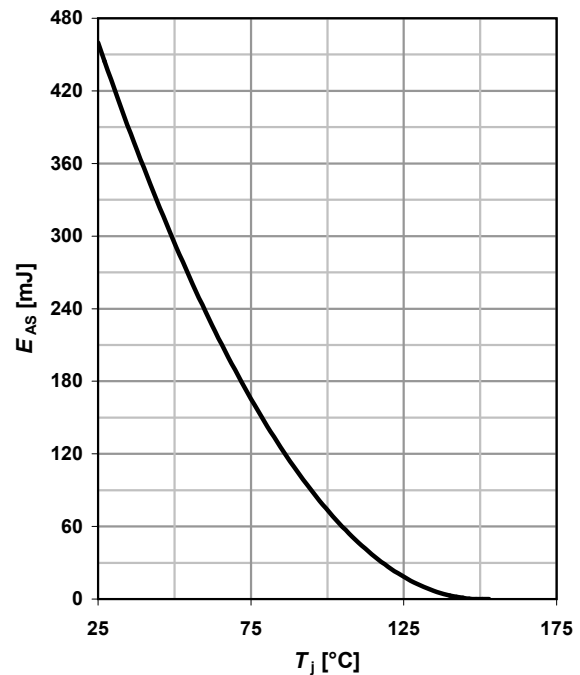

**13 Drain-source breakdown voltage**

$$V_{BR(DSS)} = f(T_j)$$

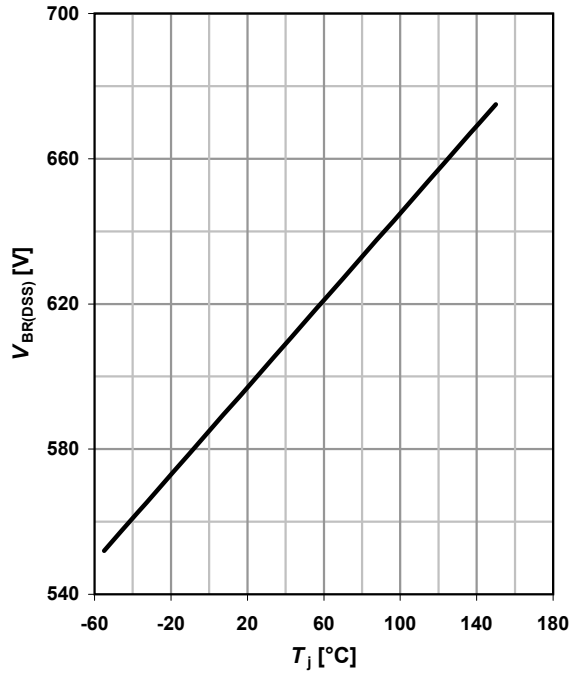

**14 Typ. capacitances**

$$C = f(V_{DS}); V_{GS} = 0 \text{ V}; f = 1 \text{ MHz}$$

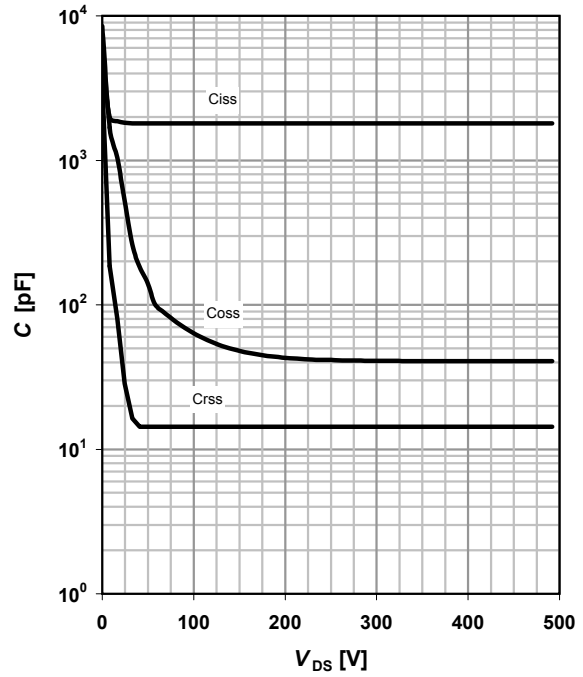

**15 Typ.  $C_{oss}$  stored energy**

$$E_{oss} = f(V_{DS})$$

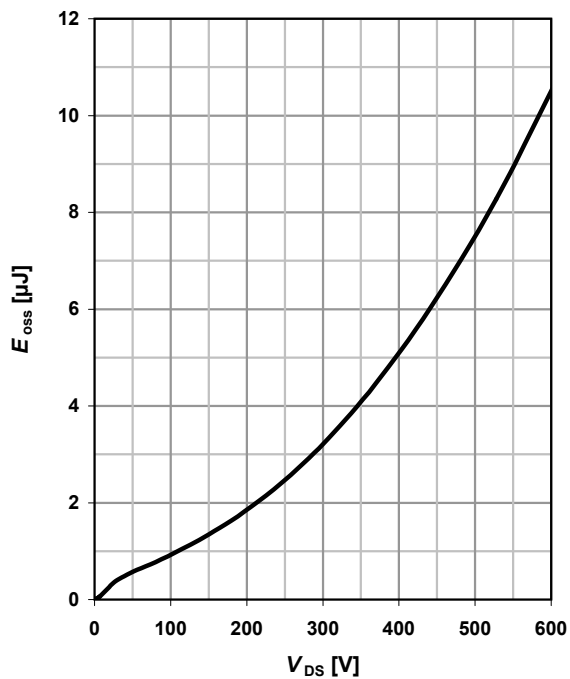

**16 Typ. reverse recovery charge**

$$Q_{rr} = f(T_j); \text{parameter: } I_D = 13.4 \text{ A}$$

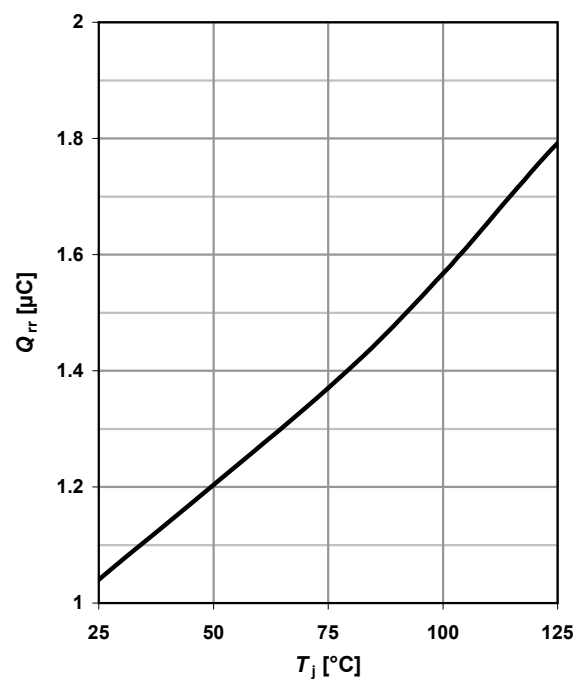



17 Typ. reverse recovery charge

$Q_{rr}=f(I_S)$ ; parameter:  $di/dt=100\text{ A}/\mu\text{s}$

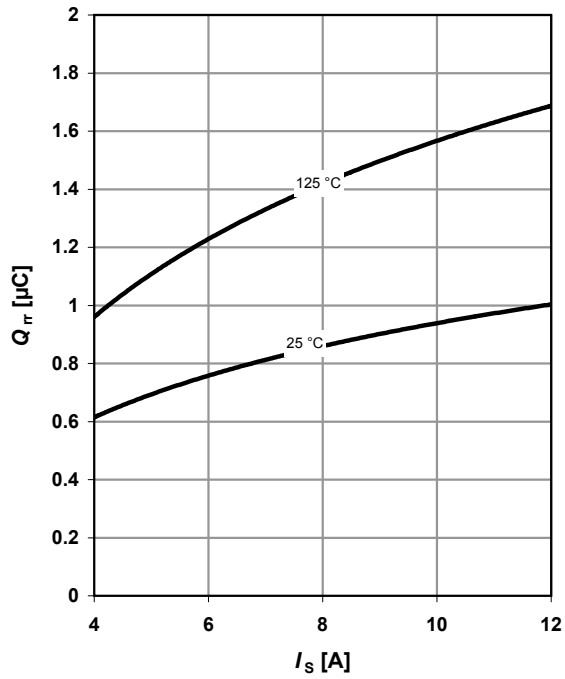

18 Typ. reverse recovery charge

$Q_{rr}=f(di/dt)$ ; parameter:  $I_D=13.4\text{ A}$

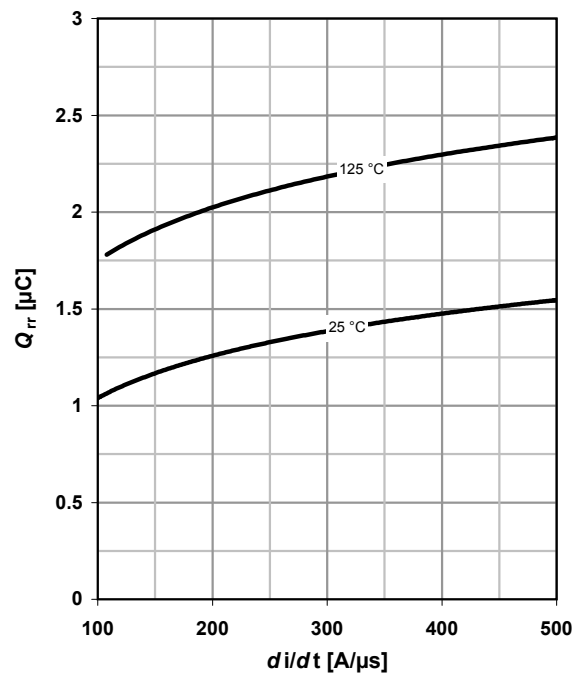

Definition of diode switching characteristics

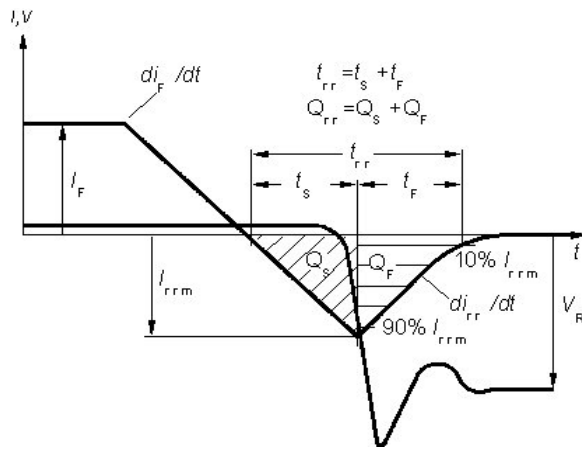

PG-TO-220-3--31; -3-111: Outlines/Fully isolated package (2500VAC; 1minute)

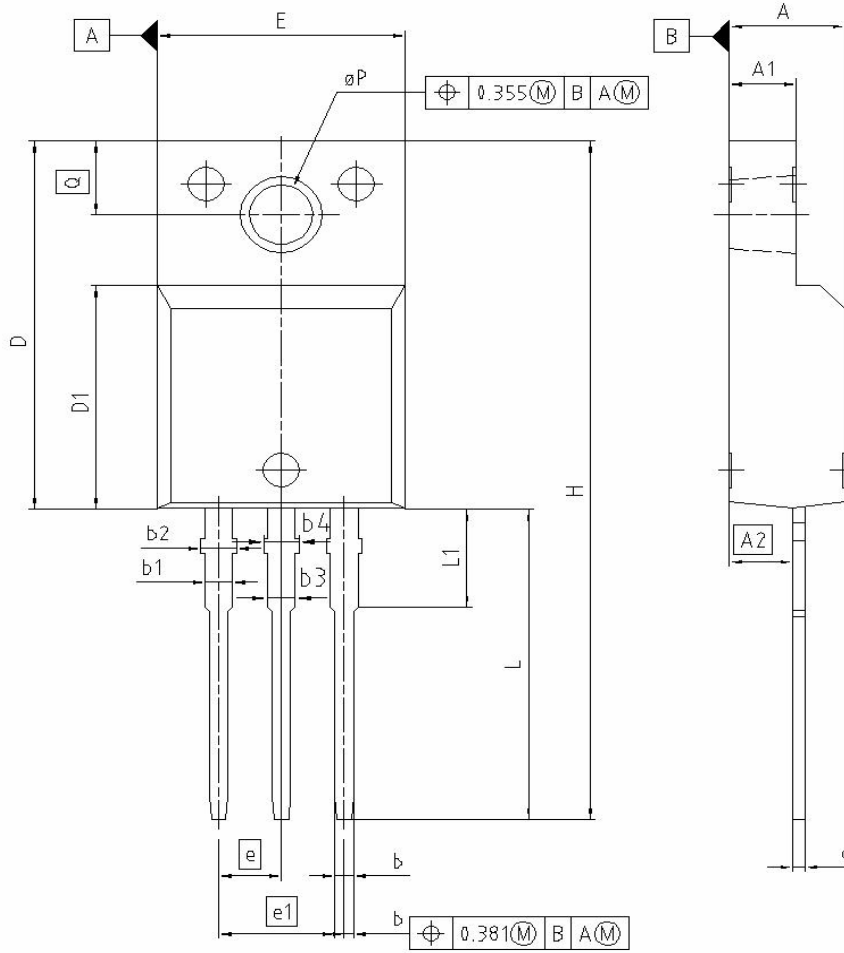

DIM	MILLIMETERS		INCHES	
	MIN	MAX	MIN	MAX
A	4.55	4.85	0.179	0.191
A1	2.55	2.85	0.100	0.112
A2	2.42	2.72	0.095	0.107
b	0.65	0.85	0.026	0.033
b1	0.95	1.33	0.037	0.052
b2	0.95	1.51	0.037	0.059
b3	0.65	1.33	0.026	0.052
b4	0.65	1.51	0.026	0.059
c	0.40	0.63	0.016	0.025
D	15.85	16.15	0.624	0.636
D1	9.53	9.83	0.375	0.387
E	10.35	10.65	0.407	0.419
e	2.54		0.100	
e1	5.08		0.200	
N	3		3	
H	29.45	29.75	1.159	1.171
L	13.45	13.75	0.530	0.541
L1	3.15	3.45	0.124	0.136
øP	2.95	3.20	0.116	0.126
Q	3.15	3.50	0.124	0.138

REFERENCE  
..

SCALE  
0 2.5 5mm

EUROPEAN PROJECTION

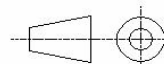

ISSUE DATE  
08-01-2007

FILE  
TO220\_2

Dimensions in mm/ inches

Published by  
Infineon Technologies AG  
81726 München, Germany  
© Infineon Technologies AG 2006.

**Attention please!**

The information given in this data sheet shall in no event be regarded as a guarantee of conditions or characteristics ("Beschaffenheitsgarantie"). With respect to any examples or hints given herein, any typical values stated herein and/or any information regarding the application of the device, Infineon Technologies non-infringement of intellectual property rights of any third party

**Information**

For further information on technology, delivery terms and conditions and prices please contact your nearest Infineon Technologies Office ([www.infineon.com](http://www.infineon.com)).

**Warnings**

Due to technical requirements components may contain dangerous substances. For information on the types in question please contact your nearest Infineon Technologies Office.

Infineon Technologies Components may only be used in life-support devices or systems with the express written approval of Infineon Technologies, if a failure of such components can reasonably be expected to cause the failure of that life-support device or system, or to affect the safety or effectiveness of that device or system. Life support devices or systems are intended to be implanted in the human body, or to support and/or maintain and sustain and/or protect human life. If they fail, it is reasonable to assume that the health of the user or other persons may be endangered.