

TIP47G, TIP48G, TIP50G

High Voltage NPN Silicon Power Transistors

This series is designed for line operated audio output amplifier, SWITCHMODE power supply drivers and other switching applications.

Features

- Popular TO-220 Plastic Package
- These Devices are Pb-Free and are RoHS Compliant*
- Complementary to the MJE5730 and MJE5731 Series

MAXIMUM RATINGS

Rating	Symbol	TIP47	TIP48	TIP50	Unit
Collector – Emitter Voltage	V_{CEO}	250	300	400	Vdc
Collector – Base Voltage	V_{CB}	350	400	500	Vdc
Emitter – Base Voltage	V_{EB}	5.0			Vdc
Collector Current – Continuous	I_C	1.0			Adc
Collector Current – Peak	I_{CM}	2.0			Adc
Base Current	I_B	0.6			Adc
Total Power Dissipation @ $T_C = 25^\circ\text{C}$ Derate above 25°C	P_D	40 0.32			W W/ $^\circ\text{C}$
Total Power Dissipation @ $T_C = 25^\circ\text{C}$ Derate above 25°C	P_D	2.0 0.016			W W/ $^\circ\text{C}$
Unclamped Inducting Load Energy (See Figure 8)	E	20			mJ
Operating and Storage Junction Temperature Range	T_J, T_{stg}	-65 to +150			$^\circ\text{C}$

Stresses exceeding Maximum Ratings may damage the device. Maximum Ratings are stress ratings only. Functional operation above the Recommended Operating Conditions is not implied. Extended exposure to stresses above the Recommended Operating Conditions may affect device reliability.

THERMAL CHARACTERISTICS

Characteristic	Symbol	Max	Unit
Thermal Resistance, Junction-to-Case	$R_{\theta JC}$	3.125	$^\circ\text{C}/\text{W}$
Thermal Resistance, Junction-to-Ambient	$R_{\theta JA}$	62.5	$^\circ\text{C}/\text{W}$

*For additional information on our Pb-Free strategy and soldering details, please download the ON Semiconductor Soldering and Mounting Techniques Reference Manual, SOLDERRM/D.



ON Semiconductor®

<http://onsemi.com>

**1.0 AMPERE
POWER TRANSISTORS
NPN SILICON
250 – 300 – 400 VOLTS
40 WATTS**

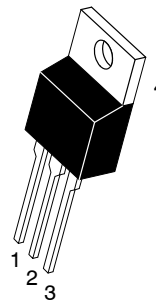
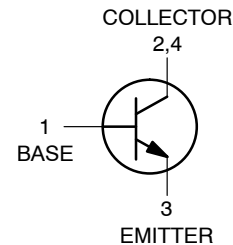

**TO-220AB
CASE 221A
STYLE 1**

MARKING DIAGRAM

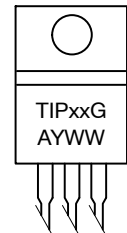

TIPxx = Device Code
 xx = 47, 48, or 50
 A = Assembly Location
 Y = Year
 WW = Work Week
 G = Pb-Free Package

ORDERING INFORMATION

See detailed ordering and shipping information in the package dimensions section on page 2 of this data sheet.

TIP47G, TIP48G, TIP50G

ELECTRICAL CHARACTERISTICS (T_C = 25°C unless otherwise noted)

Characteristic	Symbol	Min	Max	Unit	
OFF CHARACTERISTICS					
Collector–Emitter Sustaining Voltage (Note 1) (I _C = 30 mA, I _B = 0)	TIP47 TIP48 TIP50	V _{CEO(sus)}	250 300 400	– – –	Vdc
Collector Cutoff Current (V _{CE} = 150 Vdc, I _B = 0) (V _{CE} = 200 Vdc, I _B = 0) (V _{CE} = 300 Vdc, I _B = 0)	TIP47 TIP48 TIP50	I _{CEO}	– – –	1.0 1.0 1.0	mA
Collector Cutoff Current (V _{CE} = 350 Vdc, V _{BE} = 0) (V _{CE} = 400 Vdc, V _{BE} = 0) (V _{CE} = 500 Vdc, V _{BE} = 0)	TIP47 TIP48 TIP50	I _{CES}	– – –	1.0 1.0 1.0	mA
Emitter Cutoff Current (V _{BE} = 5.0 Vdc, I _C = 0)		I _{EBO}	–	1.0	mA

ON CHARACTERISTICS (Note 1)

DC Current Gain (I _C = 0.3 A, V _{CE} = 10 Vdc) (I _C = 1.0 A, V _{CE} = 10 Vdc)	h _{FE}	30 10	150 –	–
Collector–Emitter Saturation Voltage (I _C = 1.0 A, I _B = 0.2 A)	V _{CE(sat)}	–	1.0	Vdc
Base–Emitter On Voltage (I _C = 1.0 A, V _{CE} = 10 Vdc)	V _{BE(on)}	–	1.5	Vdc

DYNAMIC CHARACTERISTICS

Current–Gain – Bandwidth Product (I _C = 0.1 A, V _{CE} = 10 Vdc, f = 2.0 MHz)	f _T	10	–	MHz
Small–Signal Current Gain (I _C = 0.2 A, V _{CE} = 10 Vdc, f = 1.0 kHz)	h _{fe}	25	–	–

1. Pulse Test: Pulse width ≤ 300 μs, Duty Cycle ≤ 2.0%.

ORDERING INFORMATION

Device	Package	Shipping
TIP47G	TO–220 (Pb–Free)	50 Units / Rail
TIP48G	TO–220 (Pb–Free)	50 Units / Rail
TIP49G	TO–220 (Pb–Free)	50 Units / Rail
TIP50G	TO–220 (Pb–Free)	50 Units / Rail

TIP47G, TIP48G, TIP50G

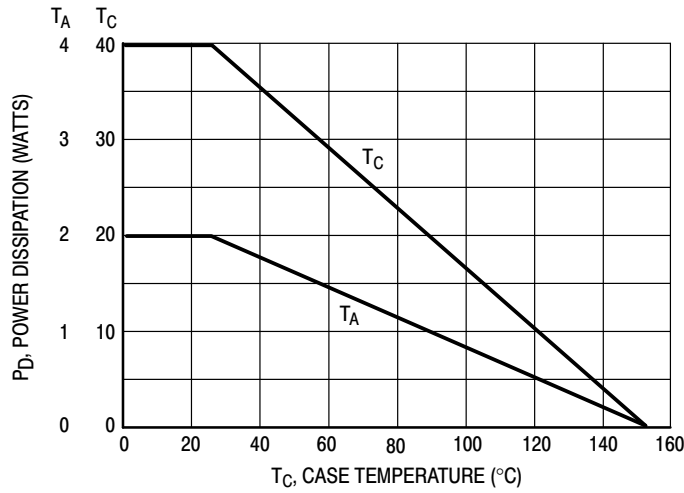
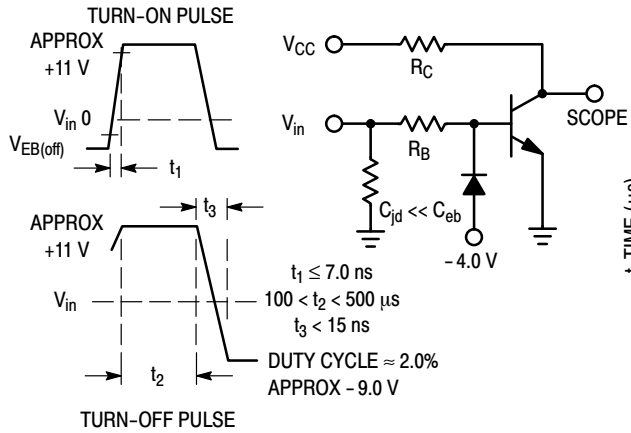

Figure 1. Power Derating



R_B and R_C VARIED TO OBTAIN DESIRED CURRENT LEVELS.

Figure 2. Switching Time Equivalent Circuit

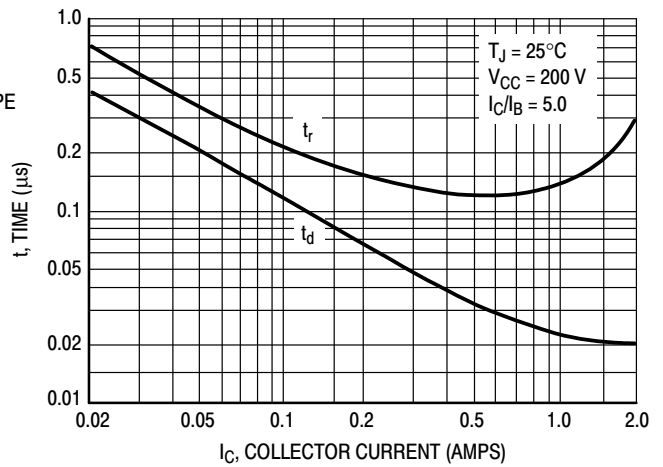

Figure 3. Turn-On Time

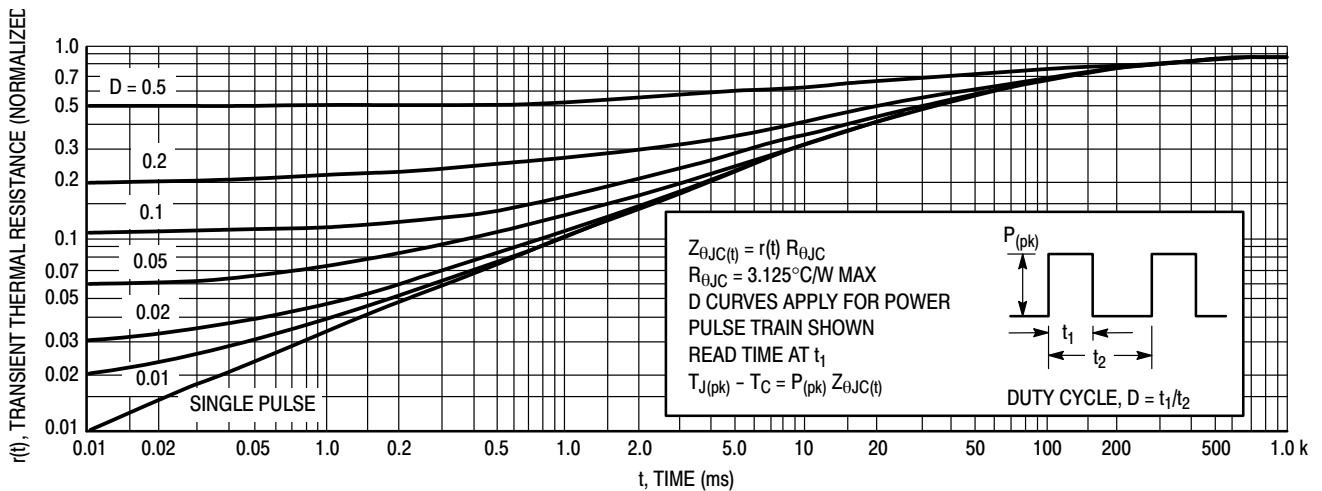

Figure 4. Thermal Response

TIP47G, TIP48G, TIP50G

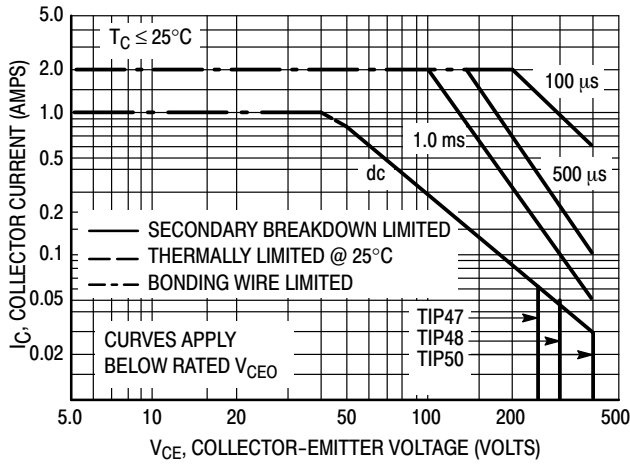

Figure 5. Active Region Safe Operating Area

There are two limitations on the power handling ability of a transistor: average junction temperature and second breakdown. Safe operating area curves indicate $I_C - V_{CE}$ limits of the transistor that must be observed for reliable operation, i.e., the transistor must not be subjected to greater dissipation than the curves indicate.

The data of Figure 5 is based on $T_{J(pk)} = 150^\circ\text{C}$; T_C is variable depending on conditions. Second breakdown pulse limits are valid for duty cycles to 10% provided $T_{J(pk)} \leq 150^\circ\text{C}$. $T_{J(pk)}$ may be calculated from the data in Figure 4. At high case temperatures, thermal limitations will reduce the power that can be handled to values less than the limitations imposed by second breakdown.

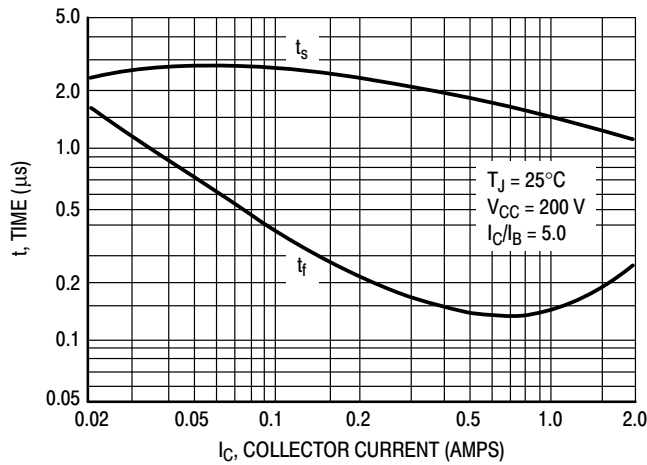

Figure 6. Turn-Off Time

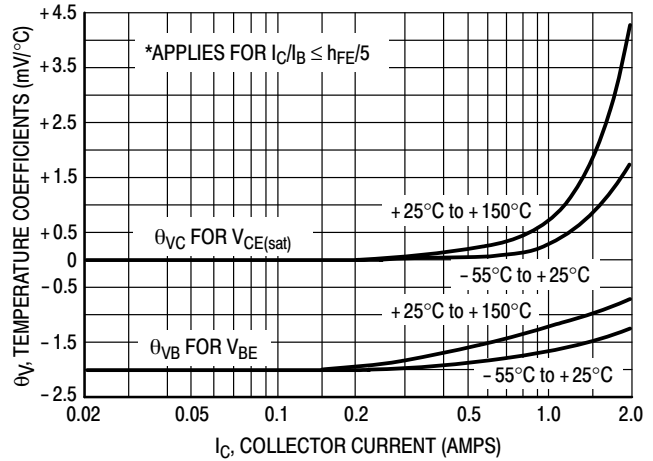
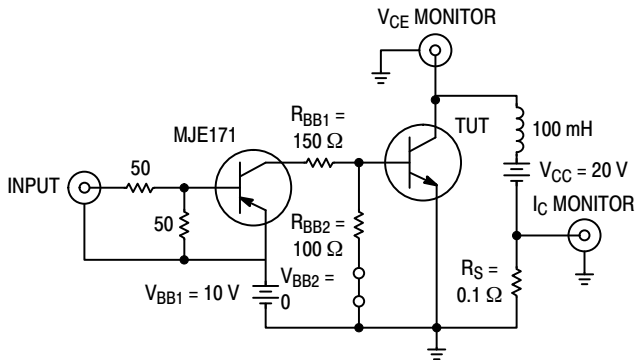

Figure 7. Temperature Coefficients



Note A: Input pulse width is increased until $I_{CM} = 0.63 \text{ A}$.

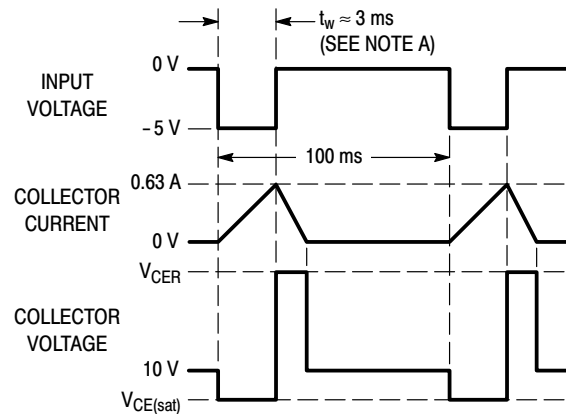

Figure 8. Inductive Load Switching

TIP47G, TIP48G, TIP50G

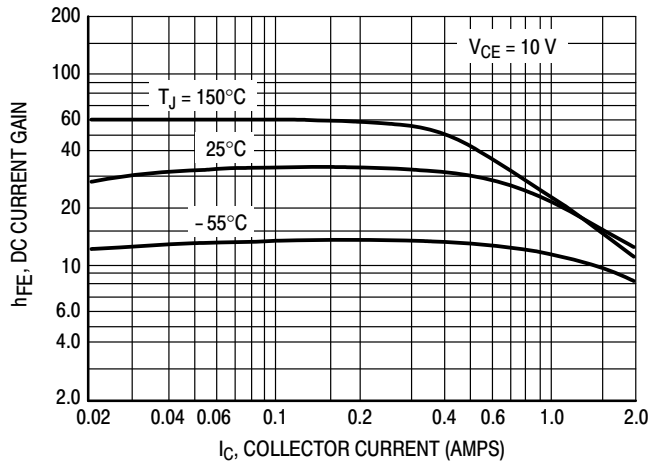

Figure 9. DC Current Gain

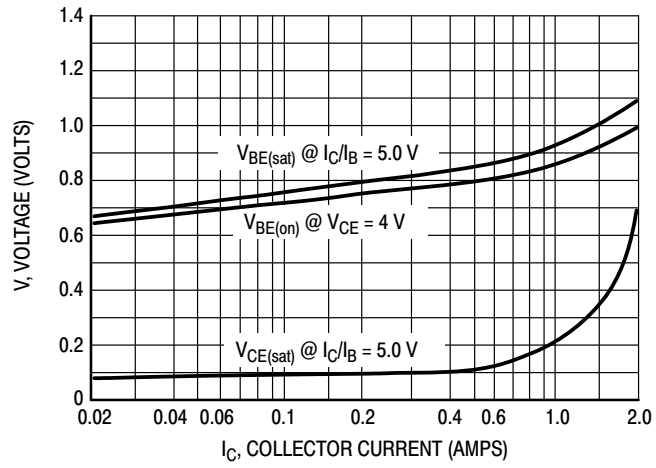
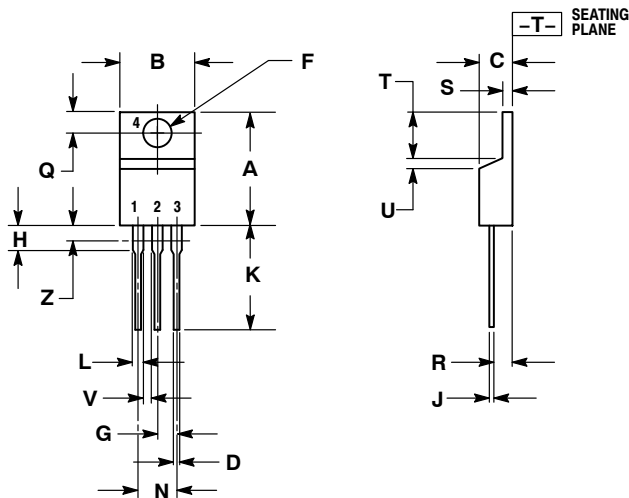

Figure 10. "On" Voltages

TIP47G, TIP48G, TIP50G

PACKAGE DIMENSIONS

TO-220 CASE 221A-09 ISSUE AG



NOTES:

1. DIMENSIONING AND TOLERANCING PER ANSI Y14.5M, 1982.
2. CONTROLLING DIMENSION: INCH.
3. DIMENSION Z DEFINES A ZONE WHERE ALL BODY AND LEAD IRREGULARITIES ARE ALLOWED.

DIM	INCHES		MILLIMETERS	
	MIN	MAX	MIN	MAX
A	0.570	0.620	14.48	15.75
B	0.380	0.405	9.66	10.28
C	0.160	0.190	4.07	4.82
D	0.025	0.036	0.64	0.91
F	0.142	0.161	3.61	4.09
G	0.095	0.105	2.42	2.66
H	0.110	0.161	2.80	4.10
J	0.014	0.025	0.36	0.64
K	0.500	0.562	12.70	14.27
L	0.045	0.060	1.15	1.52
N	0.190	0.210	4.83	5.33
Q	0.100	0.120	2.54	3.04
R	0.080	0.110	2.04	2.79
S	0.045	0.055	1.15	1.39
T	0.235	0.255	5.97	6.47
U	0.000	0.050	0.00	1.27
V	0.045	---	1.15	---
Z	---	0.080	---	2.04

STYLE 1:

- PIN 1. BASE
2. COLLECTOR
3. EMITTER
4. COLLECTOR

ON Semiconductor and **ON** are registered trademarks of Semiconductor Components Industries, LLC (SCILLC). SCILLC owns the rights to a number of patents, trademarks, copyrights, trade secrets, and other intellectual property. A listing of SCILLC's product/patent coverage may be accessed at www.onsemi.com/site/pdf/Patent-Marking.pdf. SCILLC reserves the right to make changes without further notice to any products herein. SCILLC makes no warranty, representation or guarantee regarding the suitability of its products for any particular purpose, nor does SCILLC assume any liability arising out of the application or use of any product or circuit, and specifically disclaims any and all liability, including without limitation special, consequential or incidental damages. "Typical" parameters which may be provided in SCILLC data sheets and/or specifications can and do vary in different applications and actual performance may vary over time. All operating parameters, including "Typicals" must be validated for each customer application by customer's technical experts. SCILLC does not convey any license under its patent rights nor the rights of others. SCILLC products are not designed, intended, or authorized for use as components in systems intended for surgical implant into the body, or other applications intended to support or sustain life, or for any other application in which the failure of the SCILLC product could create a situation where personal injury or death may occur. Should Buyer purchase or use SCILLC products for any such unintended or unauthorized application, Buyer shall indemnify and hold SCILLC and its officers, employees, subsidiaries, affiliates, and distributors harmless against all claims, costs, damages, and expenses, and reasonable attorney fees arising out of, directly or indirectly, any claim of personal injury or death associated with such unintended or unauthorized use, even if such claim alleges that SCILLC was negligent regarding the design or manufacture of the part. SCILLC is an Equal Opportunity/Affirmative Action Employer. This literature is subject to all applicable copyright laws and is not for resale in any manner.

PUBLICATION ORDERING INFORMATION

LITERATURE FULFILLMENT:

Literature Distribution Center for ON Semiconductor
P.O. Box 5163, Denver, Colorado 80217 USA
Phone: 303-675-2175 or 800-344-3860 Toll Free USA/Canada
Fax: 303-675-2176 or 800-344-3867 Toll Free USA/Canada
Email: orderlit@onsemi.com

N. American Technical Support: 800-282-9855 Toll Free
USA/Canada
Europe, Middle East and Africa Technical Support:
Phone: 421 33 790 2910
Japan Customer Focus Center
Phone: 81-3-5817-1050

ON Semiconductor Website: www.onsemi.com

Order Literature: <http://www.onsemi.com/orderlit>

For additional information, please contact your local Sales Representative