

# TLV2341, TLV2341Y

## LinCMOS™ PROGRAMMABLE LOW-VOLTAGE OPERATIONAL AMPLIFIERS

SLOS110A – MAY 1992 – REVISED AUGUST 1994

- **Wide Range of Supply Voltages Over Specified Temperature Range:**  
 $T_A = -40^{\circ}\text{C}$  to  $85^{\circ}\text{C}$  . . . 2 V to 8 V
- **Fully Characterized at 3 V and 5 V**
- **Single-Supply Operation**
- **Common-Mode Input-Voltage Range Extends Below the Negative Rail and up to  $V_{DD} - 1$  V at  $25^{\circ}\text{C}$**
- **Output Voltage Range Includes Negative Rail**
- **High Input Impedance . . .  $10^{12} \Omega$  Typ**
- **Low Noise . . . 25 nV/ $\sqrt{\text{Hz}}$  Typically at  $f = 1$  kHz (High-Bias Mode)**
- **ESD-Protection Circuitry**
- **Designed-In Latch-Up Immunity**
- **Bias-Select Feature Enables Maximum Supply Current Range From 17  $\mu\text{A}$  to 1.5 mA at  $25^{\circ}\text{C}$**

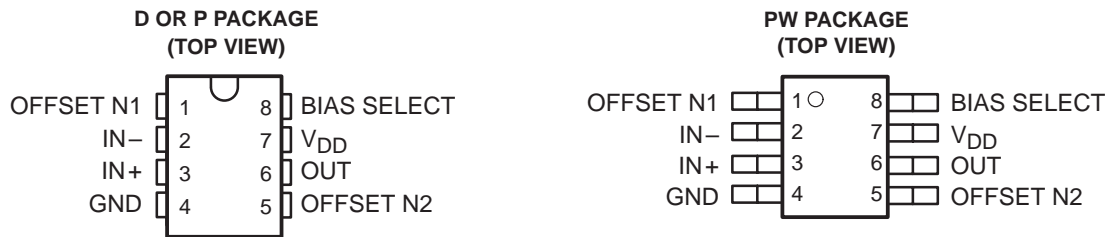

### description

The TLV2341 operational amplifier has been specifically developed for low-voltage, single-supply applications and is fully specified to operate over a voltage range of 2 V to 8 V. The device uses the Texas Instruments silicon-gate LinCMOS™ technology to facilitate low-power, low-voltage operation and excellent offset-voltage stability. LinCMOS™ technology also enables extremely high input impedance and low bias currents allowing direct interface to high-impedance sources.

The TLV2341 offers a bias-select feature, which allows the device to be programmed with a wide range of different supply currents and therefore different levels of ac performance. The supply current can be set at 17  $\mu\text{A}$ , 250  $\mu\text{A}$ , or 1.5 mA, which results in slew-rate specifications between 0.02 and 2.1 V/ $\mu\text{s}$  (at 3 V).

The TLV2341 operational amplifiers are especially well suited to single-supply applications and are fully specified and characterized at 3-V and 5-V power supplies. This low-voltage single-supply operation combined with low power consumption makes this device a good choice for remote, inaccessible, or portable battery-powered applications. The common-mode input range includes the negative rail.

The device inputs and outputs are designed to withstand  $-100\text{-mA}$  currents without sustaining latch-up. The TLV2341 incorporates internal ESD-protection circuits that prevents functional failures at voltages up to 2000 V as tested under MIL-STD 883 C, Methods 3015.2; however, care should be exercised in handling these devices as exposure to ESD may result in the degradation of the device parametric performance.

#### AVAILABLE OPTIONS

| $T_A$   | $V_{IOmax}$<br>AT $25^{\circ}\text{C}$ | PACKAGED DEVICES  |                 |              | CHIP FORM (Y) |
|---|--|-------------------|-----------------|--------------|---------------|
|   |  | SMALL OUTLINE (D) | PLASTIC DIP (P) | TSSOP (PW)   |               |
| $-40^{\circ}\text{C}$ to $85^{\circ}\text{C}$ | 8 mV                                   | TLV2341ID         | TLV2341IP       | TLV2341IPWLE | TLV2341Y      |

The D package is available taped and reeled. Add R suffix to the device type (e.g., TLV2341IDR).  
 The PW package is only available left-end taped and reeled (e.g., TLV2341IPWLE).

LinCMOS is a trademark of Texas Instruments Incorporated.

PRODUCTION DATA information is current as of publication date. Products conform to specifications per the terms of Texas Instruments standard warranty. Production processing does not necessarily include testing of all parameters.



POST OFFICE BOX 655303 • DALLAS, TEXAS 75265

Copyright © 1994, Texas Instruments Incorporated

# TLV2341, TLV2341Y LinCMOS™ PROGRAMMABLE LOW-VOLTAGE OPERATIONAL AMPLIFIERS

SLOS110A – MAY 1992 – REVISED AUGUST 1994

## bias-select feature

The TLV2342 offers a bias-select feature that allows the user to select any one of three bias levels, depending on the level of performance desired. The tradeoffs between bias levels involve ac performance and power dissipation (see Table 1).

**Table 1. Effect of Bias Selection on Performance**

| TYPICAL PARAMETER VALUES<br>$T_A = 25^\circ\text{C}$ , $V_{DD} = 3\text{ V}$ |  | MODE                                   |   |                                      | UNIT                         |
|--|--|--|---|--------------------------------------|------------------------------|
|  |  | HIGH BIAS<br>$R_L = 10\text{ k}\Omega$ | MEDIUM BIAS<br>$R_L = 100\text{ k}\Omega$ | LOW BIAS<br>$R_L = 1\text{ M}\Omega$ |                              |
| $P_D$  | Power dissipation                                    | 975                                    | 195                                       | 15                                   | $\mu\text{W}$                |
| SR   | Slew rate  | 2.1                                    | 0.38                                      | 0.02                                 | $\text{V}/\mu\text{s}$       |
| $V_n$  | Equivalent input noise voltage at $f = 1\text{ kHz}$ | 25                                     | 32  | 68                                   | $\text{nV}/\sqrt{\text{Hz}}$ |
| $B_1$  | Unity-gain bandwidth                                 | 790                                    | 300                                       | 27                                   | $\text{kHz}$                 |
| $\phi_m$   | Phase margin   | $46^\circ$                             | $39^\circ$                                | $34^\circ$                           |                              |
| $A_{VD}$   | Large-signal differential voltage amplification      | 11                                     | 83  | 400                                  | $\text{V}/\text{mV}$         |

## bias selection

Bias selection is achieved by connecting BIAS SELECT to one of three voltage levels (see Figure 1). For medium-bias applications, it is recommended that the bias-select pin be connected to the midpoint between the supply rails. This procedure is simple in split-supply applications since this point is ground. In single-supply applications, the medium-bias mode necessitates using a voltage divider as indicated in Figure 1. The use of large-value resistors in the voltage divider reduces the current drain of the divider from the supply line. However, large-value resistors used in conjunction with a large-value capacitor require significant time to charge up to the supply midpoint after the supply is switched on. A voltage other than the midpoint may be used if it is within the voltages specified in the following table.

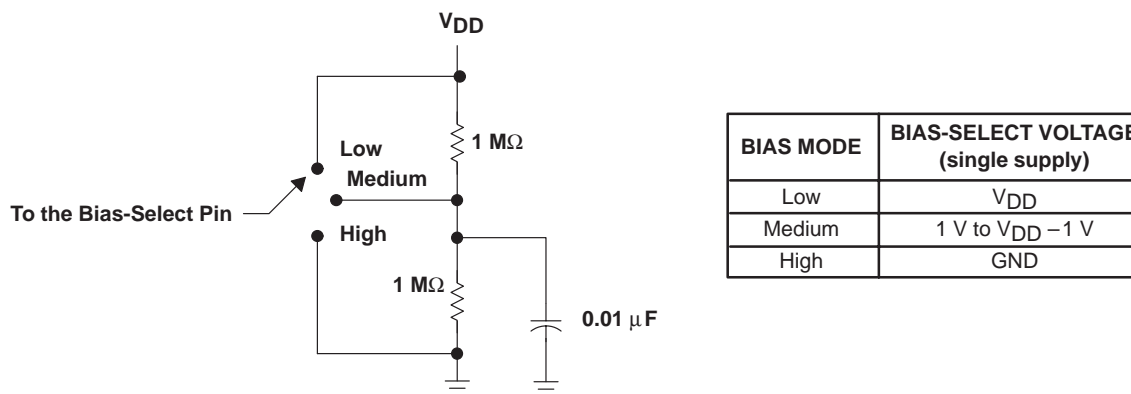

**Figure 1. Bias Selection for Single-Supply Applications**

### high-bias mode

In the high-bias mode, the TLV2341 series feature low offset voltage drift, high input impedance, and low noise. Speed in this mode approaches that of BiFET devices but at only a fraction of the power dissipation.

### medium-bias mode

The TLV2341 in the medium-bias mode features a low offset voltage drift, high input impedance, and low noise. Speed in this mode is similar to general-purpose bipolar devices but power dissipation is only a fraction of that consumed by bipolar devices.

### low-bias mode

In the low-bias mode, the TLV2341 features low offset voltage drift, high input impedance, extremely low power consumption, and high differential voltage gain.

**ORDER OF CONTENTS**

| TOPIC  | BIAS MODE                   |
|--|-----------------------------|
| Schematic  | all                         |
| Absolute maximum ratings   | all                         |
| Recommended operating conditions   | all                         |
| Electrical characteristics<br>Operating characteristics<br>Typical characteristics | high<br>(Figures 2 – 31)    |
| Electrical characteristics<br>Operating characteristics<br>Typical characteristics | medium<br>(Figures 32 – 61) |
| Electrical characteristics<br>Operating characteristics<br>Typical characteristics | low<br>(Figures 62 – 91)    |
| Parameter measurement information  | all                         |
| Application information  | all                         |

# TLV2341, TLV2341Y LinCMOS™ PROGRAMMABLE LOW-VOLTAGE OPERATIONAL AMPLIFIERS

SLOS110A – MAY 1992 – REVISED AUGUST 1994

## TLV2341Y chip information

This chip, when properly assembled, displays characteristics similar to the TLV2341. Thermal compression or ultrasonic bonding may be used on the doped-aluminum bonding pads. Chips may be mounted with conductive epoxy or a gold-silicon preform.

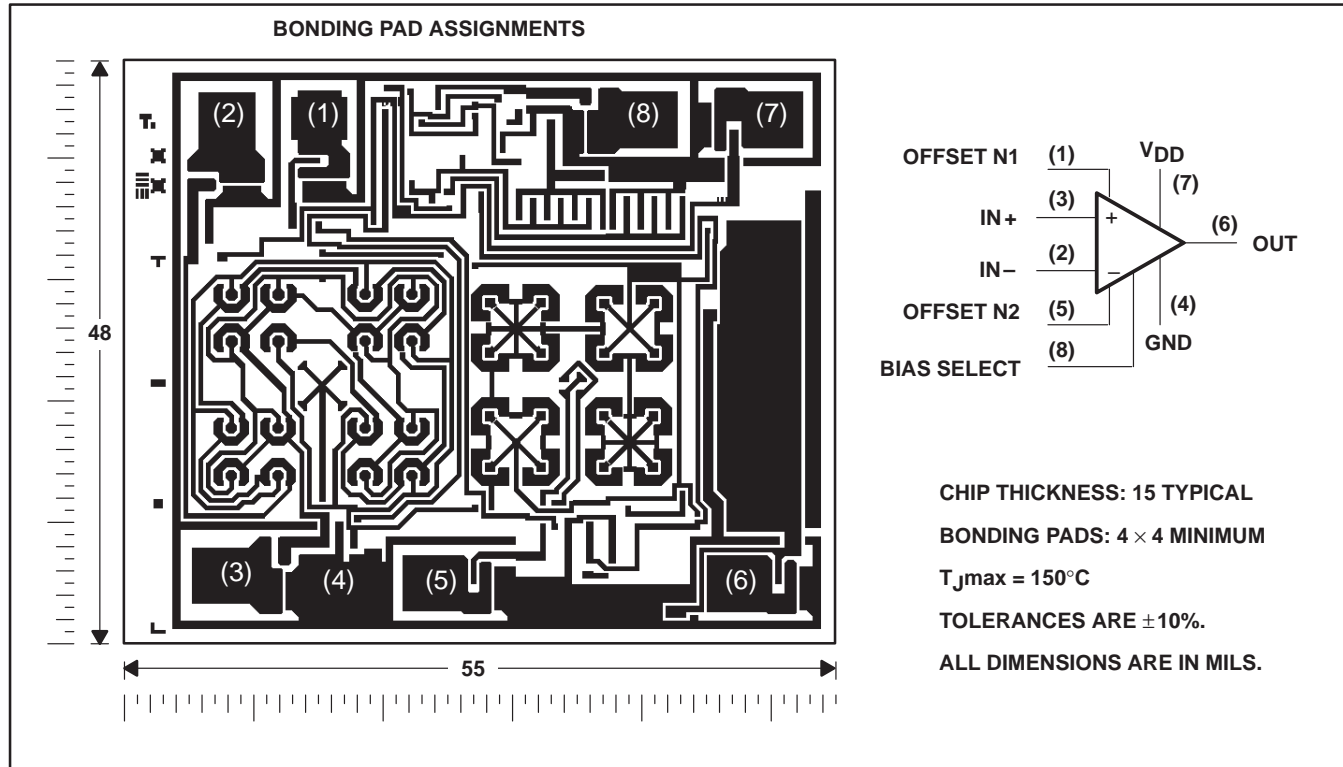

**equivalent schematic**

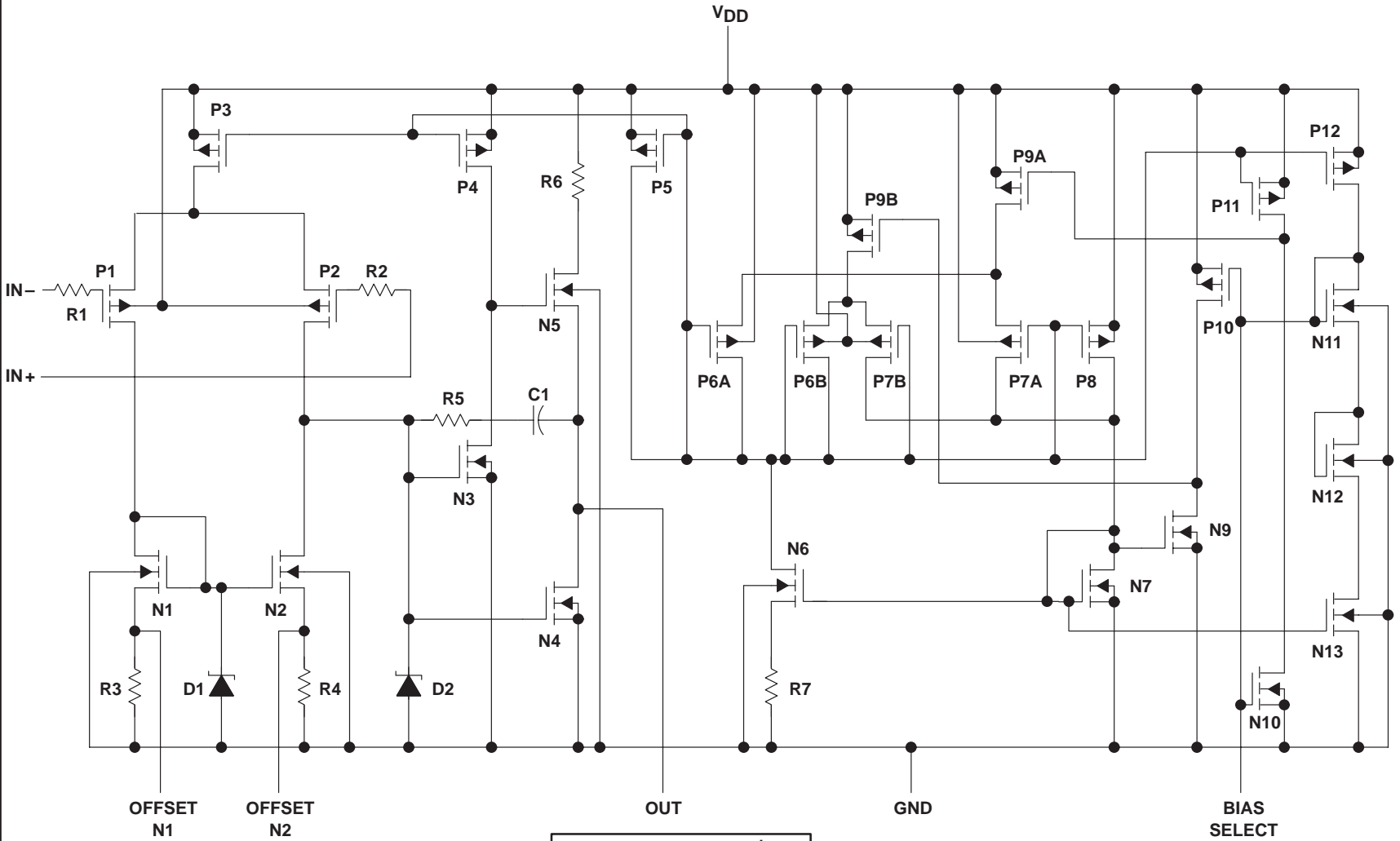

| COMPONENT COUNT† |    |
|------------------|----|
| Transistors      | 27 |
| Diodes           | 2  |
| Resistors        | 7  |
| Capacitors       | 1  |

† Includes the amplifier and all ESD, bias, and trim circuitry

**TLV2341, TLV2341Y**  
**LinCMOS™ PROGRAMMABLE LOW-VOLTAGE**  
**OPERATIONAL AMPLIFIERS**

SLOS110A – MAY 1992 – REVISED AUGUST 1994

**absolute maximum ratings over operating free-air temperature range (unless otherwise noted)†**

|   |  |
|---|--|
| Supply voltage, $V_{DD}$ (see Note 1)   | 8 V  |
| Differential input voltage (see Note 2)   | $V_{DD} \pm$                               |
| Input voltage range, $V_I$ (any input)  | -0.3 V to $V_{DD}$                         |
| Input current, $I_I$  | $\pm 5$ mA                                 |
| Output current, $I_O$   | $\pm 30$ mA                                |
| Duration of short-circuit current at (or below) $T_A = 25^\circ\text{C}$ (see Note 3) | unlimited                                  |
| Continuous total dissipation  | See Dissipation Rating Table               |
| Operating free-air temperature range, $T_A$   | $-40^\circ\text{C}$ to $85^\circ\text{C}$  |
| Storage temperature range   | $-65^\circ\text{C}$ to $150^\circ\text{C}$ |
| Lead temperature 1,6 mm (1/16 inch) from case for 10 seconds                          | $260^\circ\text{C}$                        |

† Stresses beyond those listed under "absolute maximum ratings" may cause permanent damage to the device. These are stress ratings only, and functional operation of the device at these or any conditions beyond those indicated under "recommended operating conditions" is not implied. Exposure to absolute-maximum-rated conditions for extended periods may effect device reliability.

- NOTES: 1. All voltage values, except differential voltages, are with respect to network ground.  
 2. Differential voltages are at the noninverting input with respect to the inverting input.  
 3. The output may be shorted to either supply. Temperature and/or supply voltages must be limited to ensure that the maximum dissipation rating is not exceeded (see application section).

**DISSIPATION RATING TABLE**

| PACKAGE | $T_A \leq 25^\circ\text{C}$<br>POWER RATING | DERATING FACTOR<br>ABOVE $T_A = 25^\circ\text{C}$ | $T_A = 85^\circ\text{C}$<br>POWER RATING |
|---------|---|---|--|
| D       | 725 mW                                      | 5.8 mW/ $^\circ\text{C}$                          | 377 mW                                   |
| P       | 1000 mW                                     | 8.0 mW/ $^\circ\text{C}$                          | 520 mW                                   |
| PW      | 525 mW                                      | 4.2 mW/ $^\circ\text{C}$                          | 273 mW                                   |

**recommended operating conditions**

|                                       |                | MIN  | MAX | UNIT             |
|---------------------------------------|----------------|------|-----|------------------|
| Supply voltage, $V_{DD}$              |                | 2    | 8   | V                |
| Common-mode input voltage, $V_{IC}$   | $V_{DD} = 3$ V | -0.2 | 1.8 | V                |
|                                       | $V_{DD} = 5$ V | -0.2 | 3.8 |                  |
| Operating free-air temperature, $T_A$ |                | -40  | 85  | $^\circ\text{C}$ |



### HIGH-BIAS MODE

#### electrical characteristics at specified free-air temperature

| PARAMETER   | TEST CONDITIONS   | T <sub>A</sub> † | TLV2341I              |                   |      |                       |                   |      | UNIT  |
|---|---|------------------|-----------------------|-------------------|------|-----------------------|-------------------|------|-------|
|   |   |                  | V <sub>DD</sub> = 3 V |                   |      | V <sub>DD</sub> = 5 V |                   |      |       |
|   |   |                  | MIN                   | TYP               | MAX  | MIN                   | TYP               | MAX  |       |
| V <sub>IO</sub> Input offset voltage  | V <sub>O</sub> = 1 V,<br>V <sub>IC</sub> = 1 V,<br>R <sub>S</sub> = 50 Ω,<br>R <sub>L</sub> = 10 kΩ | 25°C             | 0.6                   |                   | 8    | 1.1                   |                   | 8    | mV    |
|   |   | Full range       |                       |                   | 10   |                       |                   | 10   |       |
| α <sub>VIO</sub> Average temperature of input offset voltage                          |   | 25°C to 85°C     | 2.7                   |                   |      | 2.7                   |                   |      | μV/°C |
| I <sub>IO</sub> Input offset current (see Note 4)                                     | V <sub>O</sub> = 1 V,<br>V <sub>IC</sub> = 1 V  | 25°C             | 0.1                   |                   |      | 0.1                   |                   |      | pA    |
|   |   | 85°C             | 22                    | 1000              |      | 24                    | 1000              |      |       |
| I <sub>IB</sub> Input bias current (see Note 4)                                       | V <sub>O</sub> = 1 V,<br>V <sub>IC</sub> = 1 V  | 25°C             | 0.6                   |                   |      | 0.6                   |                   |      | pA    |
|   |   | 85°C             | 175                   | 2000              |      | 200                   | 2000              |      |       |
| V <sub>ICR</sub> Common-mode input voltage range (see Note 5)                         |   | 25°C             | -0.2<br>to<br>2       | -0.3<br>to<br>2.3 |      | -0.2<br>to<br>4       | -0.3<br>to<br>4.2 |      | V     |
|   |   | Full range       | -0.2<br>to<br>1.8     |                   |      | -0.2<br>to<br>3.8     |                   |      | V     |
| V <sub>OH</sub> High-level output voltage   | V <sub>IC</sub> = 1 V,<br>V <sub>ID</sub> = 100 mV,<br>I <sub>OH</sub> = -1 mA                      | 25°C             | 1.75                  | 1.9               |      | 3.2                   | 3.7               |      | V     |
|   |   | Full range       | 1.7                   |                   |      | 3                     |                   |      |       |
| V <sub>OL</sub> Low-level output voltage  | V <sub>IC</sub> = 1 V,<br>V <sub>ID</sub> = -100 mV,<br>I <sub>OL</sub> = 1 mA                      | 25°C             | 120                   |                   | 150  | 90                    |                   | 150  | mV    |
|   |   | Full range       |                       |                   | 190  |                       |                   | 190  |       |
| A <sub>VD</sub> Large-signal differential voltage amplification                       | V <sub>IC</sub> = 1 V,<br>R <sub>L</sub> = 10 kΩ,<br>See Note 6                                     | 25°C             | 3                     | 11                |      | 5                     | 23                |      | V/mV  |
|   |   | Full range       | 2                     |                   |      | 3.5                   |                   |      |       |
| CMRR Common-mode rejection ratio  | V <sub>O</sub> = 1 V,<br>V <sub>IC</sub> = V <sub>ICRmin</sub> ,<br>R <sub>S</sub> = 50 Ω           | 25°C             | 65                    | 78                |      | 65                    | 80                |      | dB    |
|   |   | Full range       | 60                    |                   |      | 60                    |                   |      |       |
| k <sub>SVR</sub> Supply-voltage rejection ratio (ΔV <sub>DD</sub> /ΔV <sub>IO</sub> ) | V <sub>IC</sub> = 1 V,<br>V <sub>O</sub> = 1 V,<br>R <sub>S</sub> = 50 Ω                            | 25°C             | 70                    | 95                |      | 70                    | 95                |      | dB    |
|   |   | Full range       | 65                    |                   |      | 65                    |                   |      |       |
| I <sub>I(SEL)</sub> Bias select current   | V <sub>I(SEL)</sub> = 0   | 25°C             | -1.2                  |                   |      | -1.4                  |                   |      | μA    |
| I <sub>DD</sub> Supply current  | V <sub>O</sub> = 1 V,<br>V <sub>IC</sub> = 1 V,<br>No load  | 25°C             | 325                   | 1500              |      | 675                   | 1600              |      | μA    |
|   |   | Full range       |                       |                   | 2000 |                       |                   | 2200 |       |

† Full range is -40°C to 85°C.

- NOTES: 4. The typical values of input bias current and input offset current below 5 pA are determined mathematically.  
 5. This range also applies to each input individually.  
 6. At V<sub>DD</sub> = 5 V, V<sub>O</sub> = 0.25 V to 2 V; at V<sub>DD</sub> = 3 V, V<sub>O</sub> = 0.5 V to 1.5 V.

**HIGH-BIAS MODE**

**operating characteristics at specified free-air temperature,  $V_{DD} = 3\text{ V}$**

| PARAMETER                                      | TEST CONDITIONS   | $T_A$  | TLV2341I |     |     | UNIT                   |
|--|---|--|----------|-----|-----|------------------------|
|  |   |  | MIN      | TYP | MAX |                        |
| SR Slew rate at unity gain                     | $V_{IC} = 1\text{ V}$ ,<br>$R_L = 10\text{ k}\Omega$ ,<br>See Figure 92 | $V_{I(PP)} = 1\text{ V}$ ,<br>$C_L = 20\text{ pF}$ | 25°C     | 2.1 |     | V/ $\mu$ s             |
|  |   |  | 85°C     | 1.7 |     |                        |
| $V_n$ Equivalent input noise voltage           | $f = \text{kHz}$ ,<br>See Figure 93                                     | $R_S = 20\ \Omega$                                 | 25°C     | 25  |     | nV/ $\sqrt{\text{Hz}}$ |
| B <sub>OM</sub> Maximum output-swing bandwidth | $V_O = V_{OH}$ ,<br>$R_L = 10\text{ k}\Omega$ ,<br>See Figure 92        | $C_L = 20\text{ pF}$                               | 25°C     | 170 |     | kHz                    |
|  |   |  | 85°C     | 145 |     |                        |
| B <sub>1</sub> Unity-gain bandwidth            | $V_I = 10\text{ mV}$ ,<br>$R_L = 10\text{ k}\Omega$ ,<br>See Figure 94  | $C_L = 20\text{ pF}$                               | 25°C     | 790 |     | kHz                    |
|  |   |  | 85°C     | 690 |     |                        |
| $\phi_m$ Phase margin                          | $V_I = 10\text{ mV}$ ,<br>$C_L = 20\text{ pF}$ ,<br>See Figure 94       | $f = B_1$ ,<br>$R_L = 1\text{ M}\Omega$            | -40°C    | 53° |     |                        |
|  |   |  | 25°C     | 49° |     |                        |
|  |   |  | 85°C     | 47° |     |                        |

**operating characteristics at specified free-air temperature,  $V_{DD} = 5\text{ V}$**

| PARAMETER                                      | TEST CONDITIONS   | $T_A$                                    | TLV2341I |     |     | UNIT                   |
|--|---|--|----------|-----|-----|------------------------|
|  |   |  | MIN      | TYP | MAX |                        |
| SR Slew rate at unity gain                     | $V_{IC} = 1\text{ V}$ ,<br>$R_L = 10\text{ k}\Omega$ ,<br>$C_L = 20\text{ pF}$ ,<br>See Figure 92 | $V_{I(PP)} = 1\text{ V}$                 | 25°C     | 3.6 |     | V/ $\mu$ s             |
|  |   |  | 85°C     | 2.8 |     |                        |
|  |   | $V_{I(PP)} = 2.5\text{ V}$               | 25°C     | 2.9 |     |                        |
|  |   |  | 85°C     | 2.3 |     |                        |
| $V_n$ Equivalent input noise voltage           | $f = 1\text{ kHz}$ ,<br>See Figure 93   | $R_S = 20\ \Omega$                       | 25°C     | 25  |     | nV/ $\sqrt{\text{Hz}}$ |
| B <sub>OM</sub> Maximum output-swing bandwidth | $V_O = V_{OH}$ ,<br>$R_L = 10\text{ k}\Omega$ ,<br>See Figure 92                                  | $C_L = 20\text{ pF}$                     | 25°C     | 320 |     | kHz                    |
|  |   |  | 85°C     | 250 |     |                        |
| B <sub>1</sub> Unity-gain bandwidth            | $V_I = 10\text{ mV}$ ,<br>$R_L = 10\text{ k}\Omega$ ,<br>See Figure 94                            | $C_L = 20\text{ pF}$                     | 25°C     | 1.7 |     | MHz                    |
|  |   |  | 85°C     | 1.2 |     |                        |
| $\phi_m$ Phase margin                          | $V_I = 10\text{ mV}$ ,<br>$C_L = 20\text{ pF}$ ,<br>See Figure 94                                 | $f = B_1$ ,<br>$R_L = 10\text{ k}\Omega$ | -40°C    | 49° |     |                        |
|  |   |  | 25°C     | 46° |     |                        |
|  |   |  | 85°C     | 43° |     |                        |



### HIGH-BIAS MODE

electrical characteristics,  $T_A = 25^\circ\text{C}$

| PARAMETER  | TEST CONDITIONS  | TLV2341I              |                   |      |                       |                   |      | UNIT          |
|--|--|-----------------------|-------------------|------|-----------------------|-------------------|------|---------------|
|  |  | $V_{DD} = 3\text{ V}$ |                   |      | $V_{DD} = 5\text{ V}$ |                   |      |               |
|  |  | MIN                   | TYP               | MAX  | MIN                   | TYP               | MAX  |               |
| $V_{IO}$ Input offset voltage  | $V_O = 1\text{ V}$ , $V_{IC} = 1\text{ V}$ ,<br>$R_S = 50\ \Omega$ , $R_L = 10\text{ k}\Omega$ |                       | 0.6               | 8    |                       | 1.1               | 8    | mV            |
| $I_{IO}$ Input offset current (see Note 4)                                 | $V_O = 1\text{ V}$ , $V_{IC} = 1\text{ V}$   |                       | 0.1               |      |                       | 0.1               |      | pA            |
| $I_{IB}$ Input bias current (see Note 4)                                   | $V_O = 1\text{ V}$ , $V_{IC} = 1\text{ V}$   |                       | 0.6               |      |                       | 0.6               |      | pA            |
| $V_{ICR}$ Common-mode input voltage range (see Note 5)                     |  | -0.2<br>to<br>2       | -0.3<br>to<br>2.3 |      | -0.2<br>to<br>4       | -0.3<br>to<br>4.2 |      | V             |
| $V_{OH}$ High-level output voltage   | $V_{IC} = 1\text{ V}$ , $V_{ID} = 100\text{ mV}$ ,<br>$I_{OH} = -1\text{ mA}$                  | 1.75                  | 1.9               |      | 3.2                   | 3.7               |      | V             |
| $V_{OL}$ Low-level output voltage  | $V_{IC} = 1\text{ V}$ , $V_{ID} = -100\text{ mV}$ ,<br>$I_{OL} = 1\text{ mA}$                  |                       | 120               | 150  |                       | 90                | 150  | mV            |
| $A_{VD}$ Large-signal differential voltage amplification                   | $V_{IC} = 1\text{ V}$ , $R_L = 10\text{ k}\Omega$ ,<br>See Note 6                              | 3                     | 11                |      | 50                    | 23                |      | V/mV          |
| CMRR Common-mode rejection ratio   | $V_O = 1\text{ V}$ , $V_{IC} = V_{ICR\text{min}}$ ,<br>$R_S = 50\ \Omega$                      | 65                    | 78                |      | 65                    | 80                |      | dB            |
| $k_{SVR}$ Supply-voltage rejection ratio ( $\Delta V_{DD}/\Delta V_{IO}$ ) | $V_O = 1\text{ V}$ , $V_{IC} = 1\text{ V}$ ,<br>$R_S = 50\ \Omega$                             | 70                    | 95                |      | 70                    | 95                |      | dB            |
| $I_{I(SEL)}$ Bias select current   | $V_{I(SEL)} = 0$   |                       | -1.2              |      |                       | -1.4              |      | $\mu\text{A}$ |
| $I_{DD}$ Supply current  | $V_O = 1\text{ V}$ , $V_{IC} = 1\text{ V}$ ,<br>No load  |                       | 325               | 1500 |                       | 675               | 1600 | $\mu\text{A}$ |

- NOTES: 4. The typical values of input bias current and input offset current below 5 pA are determined mathematically.  
 5. This range also applies to each input individually.  
 6. At  $V_{DD} = 5\text{ V}$ ,  $V_O = 0.25\text{ V}$  to  $2\text{ V}$ ; at  $V_{DD} = 3\text{ V}$ ,  $V_O = 0.5\text{ V}$  to  $1.5\text{ V}$ .

**TYPICAL CHARACTERISTICS (HIGH-BIAS MODE)**

**Table of Graphs**

|                |   | <b>FIGURE</b>                 |        |
|----------------|---|-------------------------------|--------|
| $V_{IO}$       | Input offset voltage                            | Distribution                  | 2,3    |
| $\alpha_{VIO}$ | Input offset voltage temperature coefficient    | Distribution                  | 4,5    |
| $V_{OH}$       | High-level output voltage                       | vs Output current             | 6      |
|                |   | vs Supply voltage             | 7      |
|                |   | vs Temperature                | 8      |
| $V_{OL}$       | Low-level output voltage                        | vs Common-mode input voltage  | 9      |
|                |   | vs Temperature                | 10, 12 |
|                |   | vs Differential input voltage | 11     |
|                |   | vs Low-level output current   | 13     |
| $A_{VD}$       | Large-signal differential voltage amplification | vs Supply voltage             | 14     |
|                |   | vs Temperature                | 15     |
|                |   | vs Frequency                  | 26, 27 |
| $I_{IB}$       | Input bias current                              | vs Temperature                | 16     |
| $I_{IO}$       | Input offset current                            | vs Temperature                | 16     |
| $V_{IC}$       | Common-mode input voltage                       | vs Supply voltage             | 17     |
| $I_{DD}$       | Supply current                                  | vs Supply voltage             | 18     |
|                |   | vs Temperature                | 19     |
| SR             | Slew rate                                       | vs Supply voltage             | 20     |
|                |   | vs Temperature                | 21     |
|                | Bias select current                             | vs Supply voltage             | 22     |
| $V_{O(PP)}$    | Maximum peak-to-peak output voltage             | vs Frequency                  | 23     |
| $B_1$          | Unity-gain bandwidth                            | vs Temperature                | 24     |
|                |   | vs Supply voltage             | 25     |
| $\phi_m$       | Phase margin                                    | vs Supply voltage             | 28     |
|                |   | vs Temperature                | 29     |
|                |   | vs Load capacitance           | 30     |
| $V_n$          | Equivalent input noise voltage                  | vs Frequency                  | 31     |
|                |   | Phase shift                   | 26, 27 |

**TYPICAL CHARACTERISTICS (HIGH-BIAS MODE)**

**DISTRIBUTION OF TLV2341  
 INPUT OFFSET VOLTAGE**

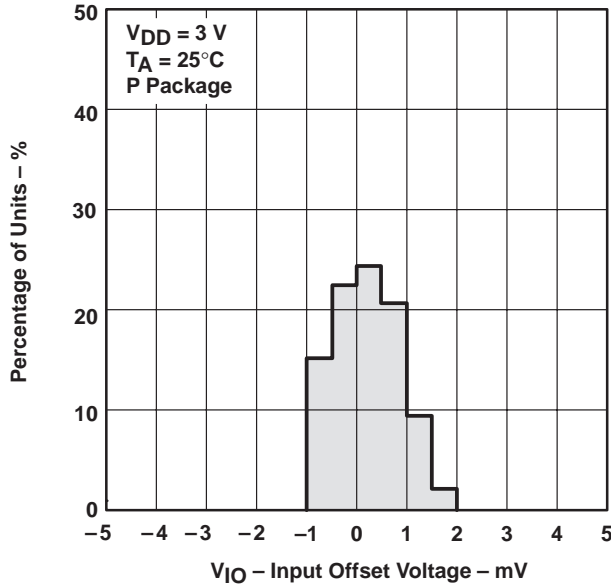

**Figure 2**

**DISTRIBUTION OF TLV2341  
 INPUT OFFSET VOLTAGE**

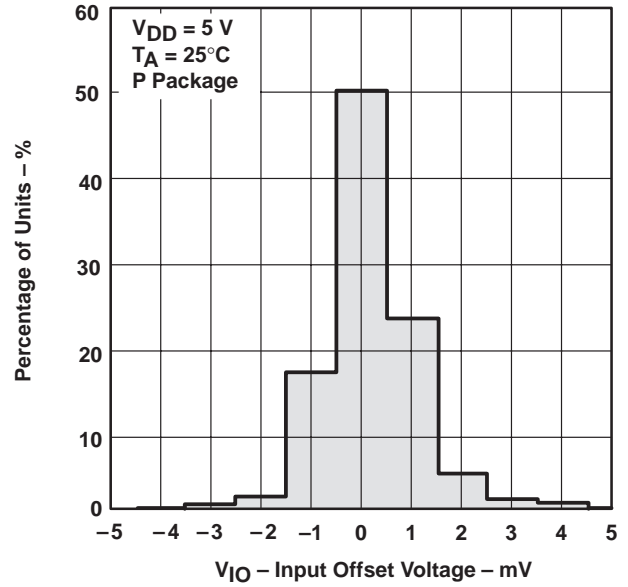

**Figure 3**

**DISTRIBUTION OF TLV2341  
 INPUT OFFSET VOLTAGE  
 TEMPERATURE COEFFICIENT**

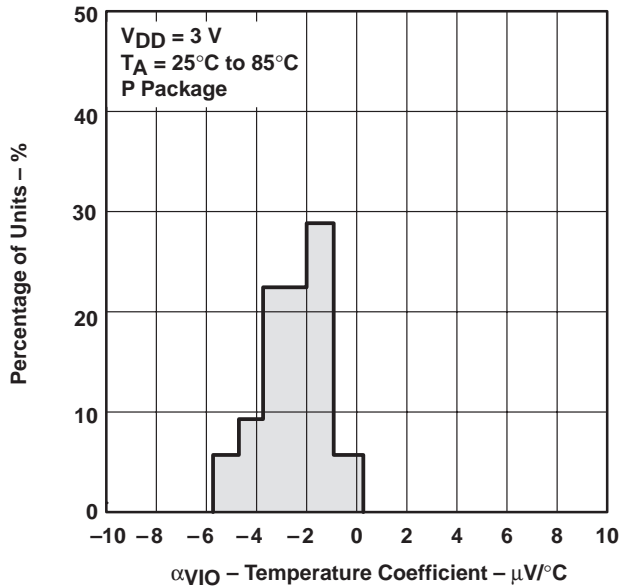

**Figure 4**

**DISTRIBUTION OF TLV2341  
 INPUT OFFSET VOLTAGE  
 TEMPERATURE COEFFICIENT**

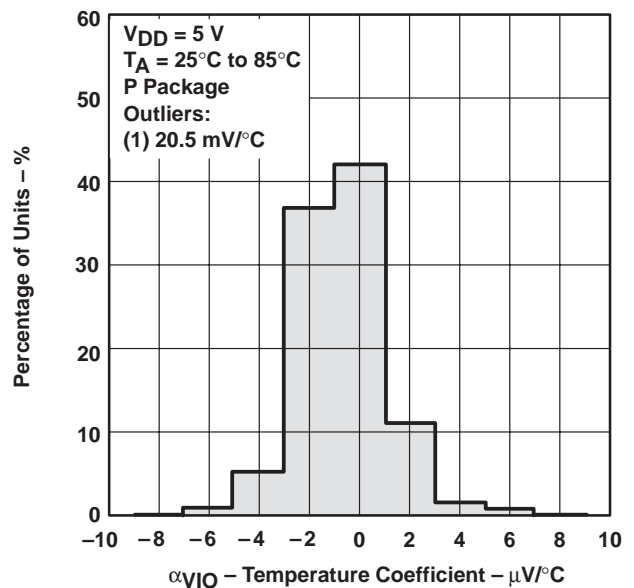

**Figure 5**

TYPICAL CHARACTERISTICS (HIGH-BIAS MODE)

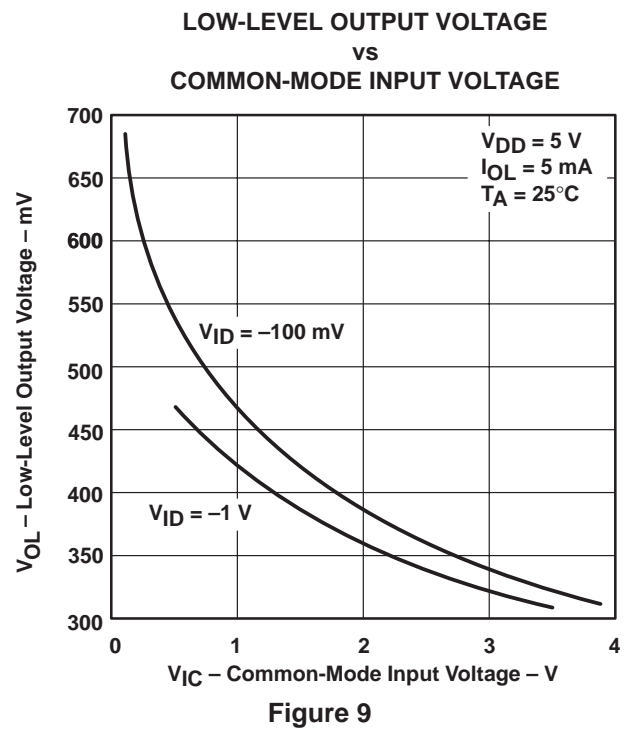
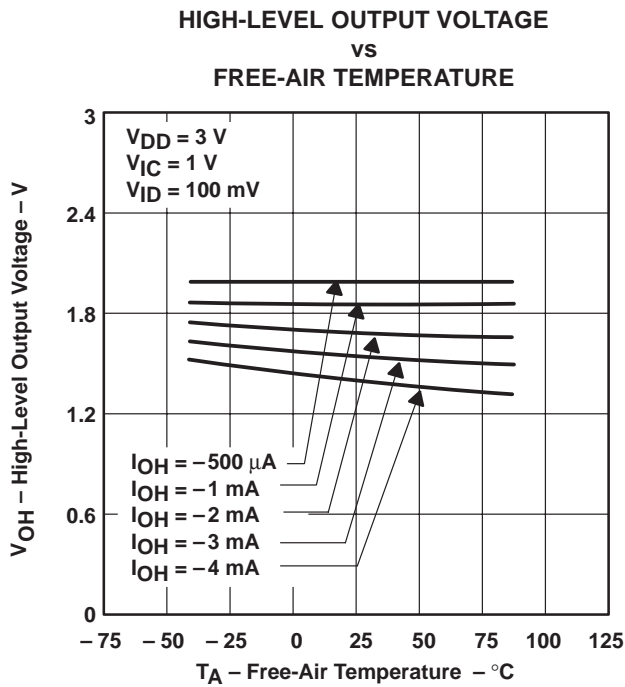
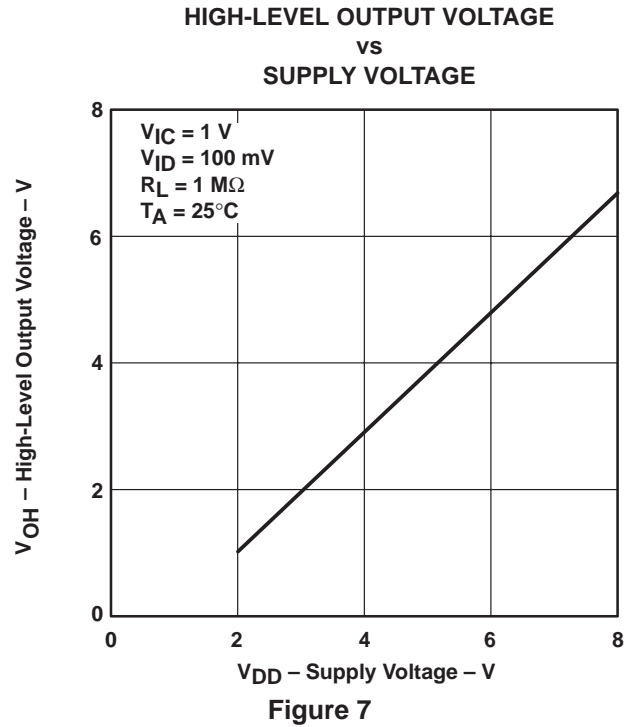
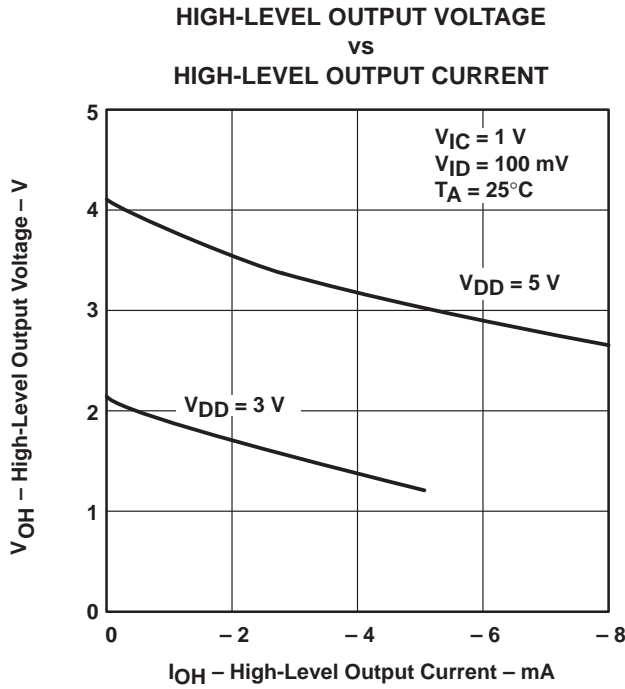

TYPICAL CHARACTERISTICS (HIGH-BIAS MODE)

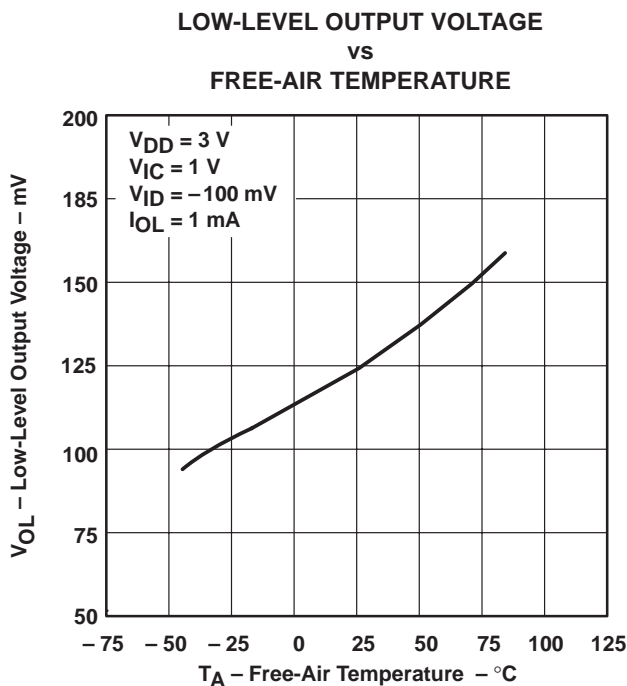

Figure 10

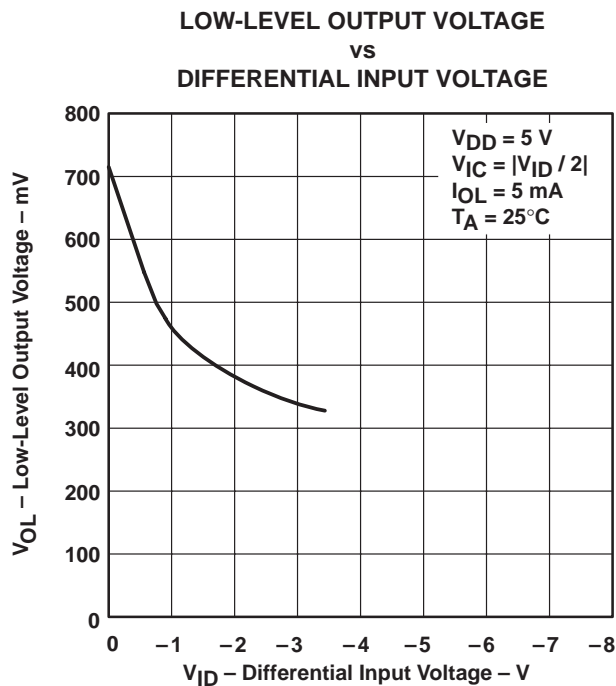

Figure 11

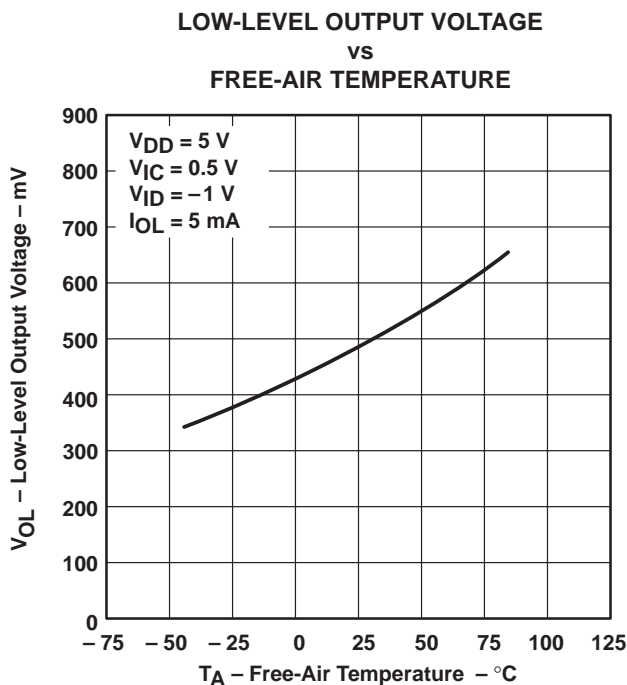

Figure 12

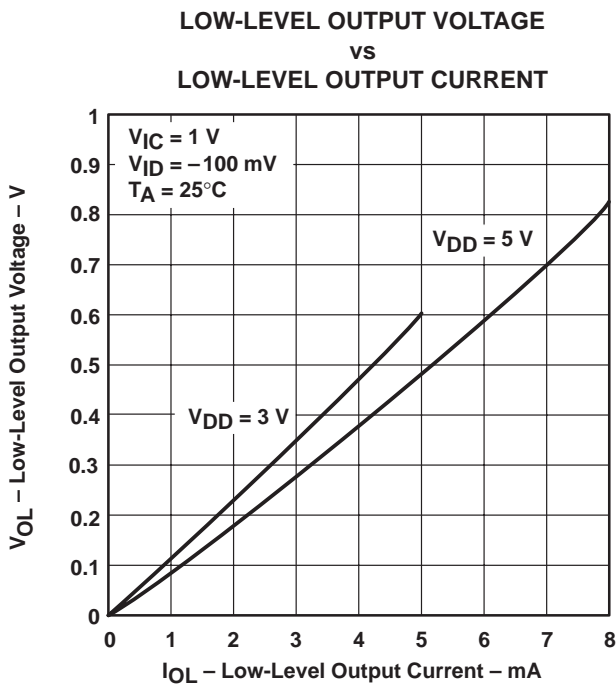

Figure 13

**TYPICAL CHARACTERISTICS (HIGH-BIAS MODE)**

**LARGE-SIGNAL DIFFERENTIAL VOLTAGE AMPLIFICATION VS SUPPLY VOLTAGE**

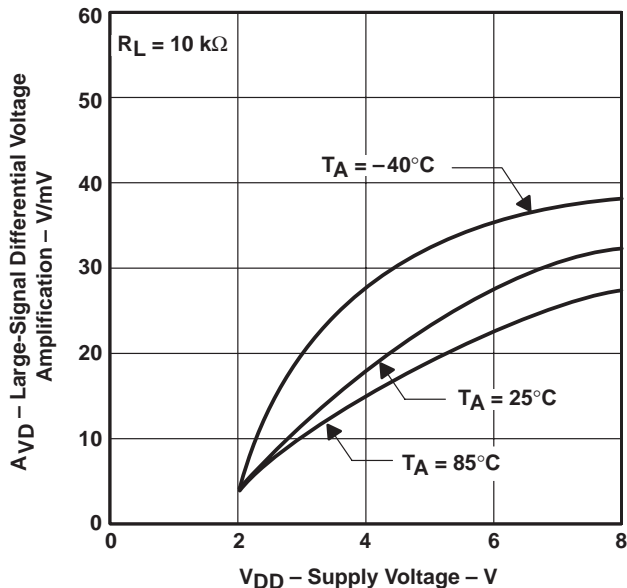

Figure 14

**LARGE-SIGNAL DIFFERENTIAL VOLTAGE AMPLIFICATION VS FREE-AIR TEMPERATURE**

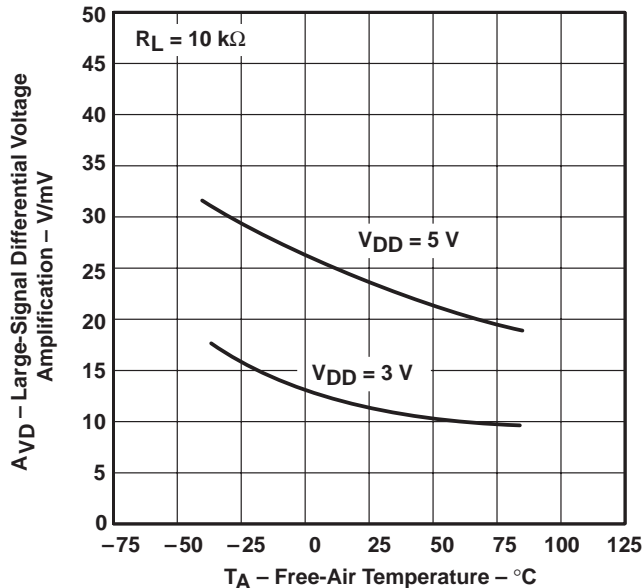

Figure 15

**INPUT BIAS CURRENT AND INPUT OFFSET CURRENT VS FREE-AIR TEMPERATURE**

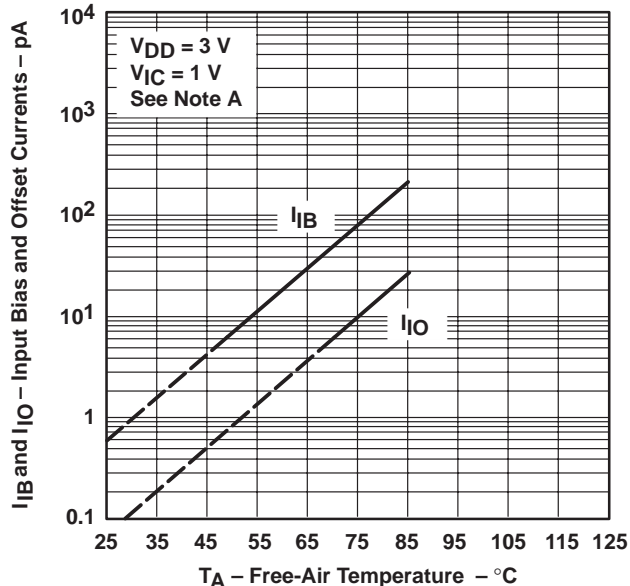

Figure 16

**COMMON-MODE INPUT VOLTAGE POSITIVE LIMIT VS SUPPLY VOLTAGE**

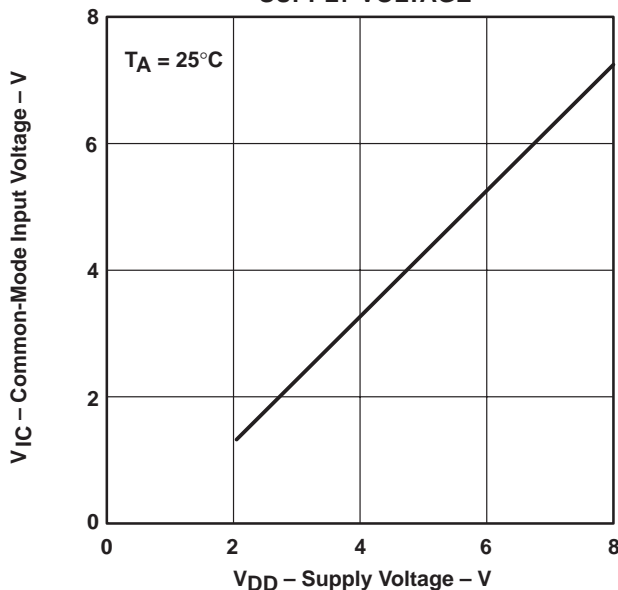

Figure 17

NOTE: The typical values of input bias current and input offset current below 5 pA were determined mathematically.

**TYPICAL CHARACTERISTICS (HIGH-BIAS MODE)**

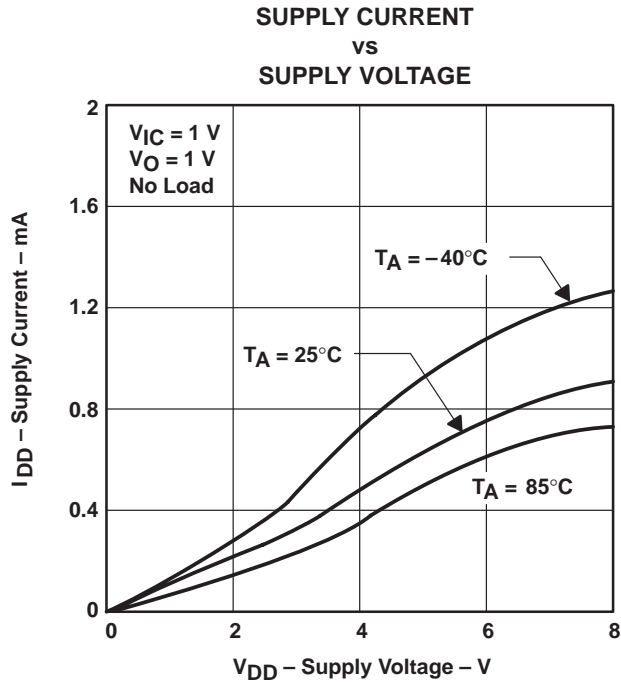

Figure 18

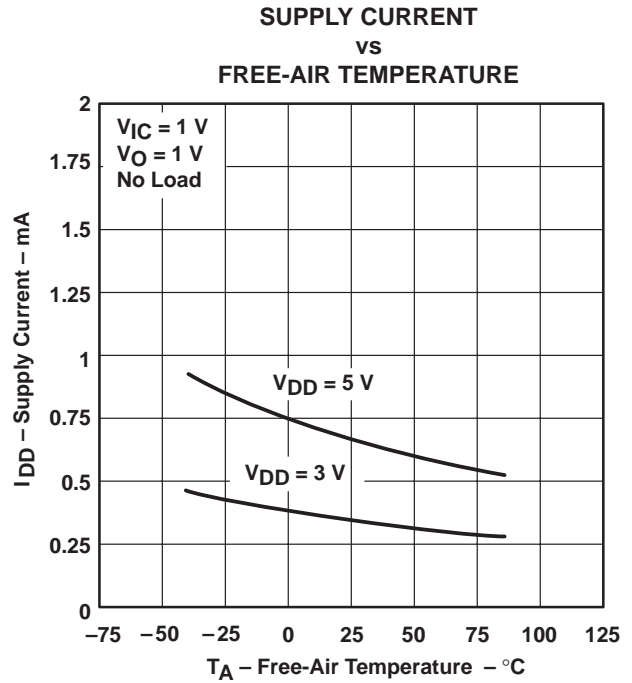

Figure 19

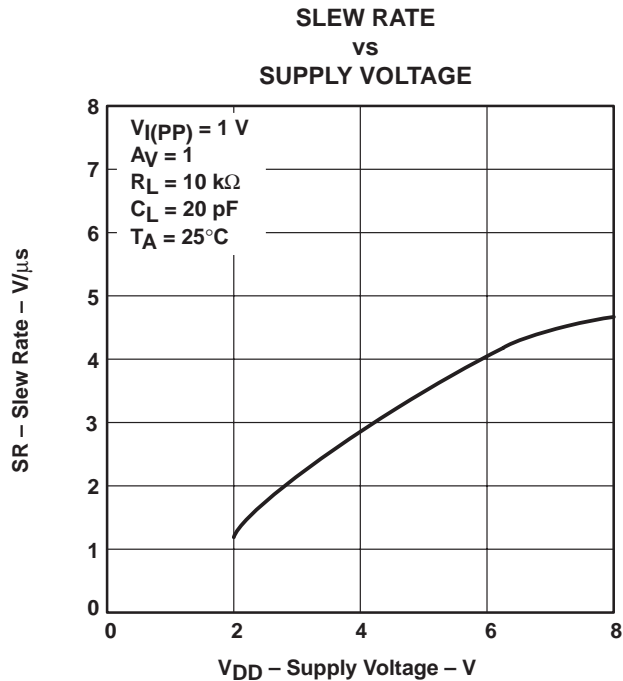

Figure 20

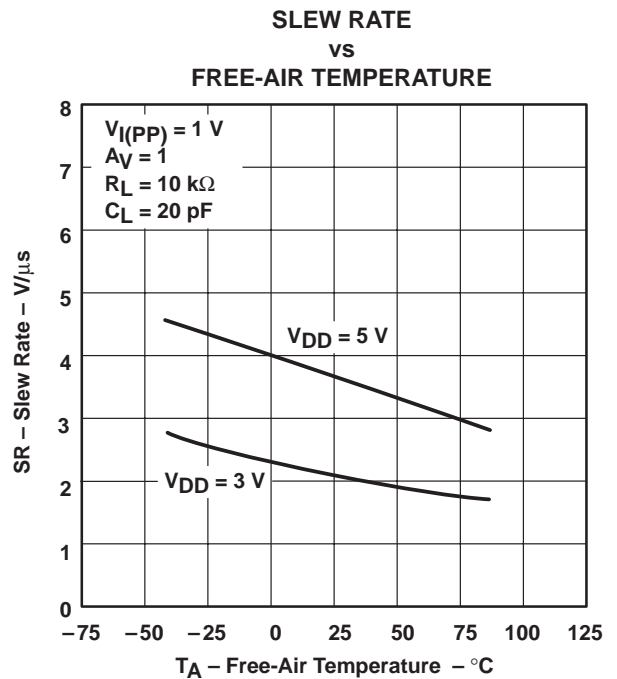

Figure 21

TYPICAL CHARACTERISTICS (HIGH-BIAS MODE)

BIAS SELECT CURRENT  
 vs  
 SUPPLY VOLTAGE

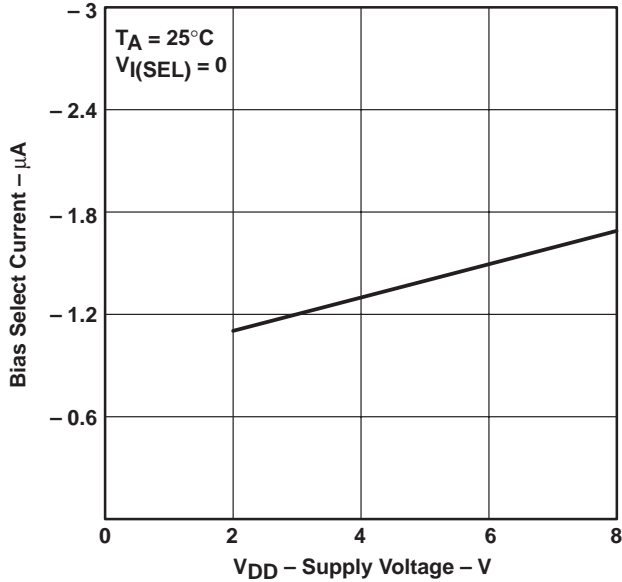

Figure 22

MAXIMUM PEAK-TO-PEAK OUTPUT VOLTAGE  
 vs  
 FREQUENCY

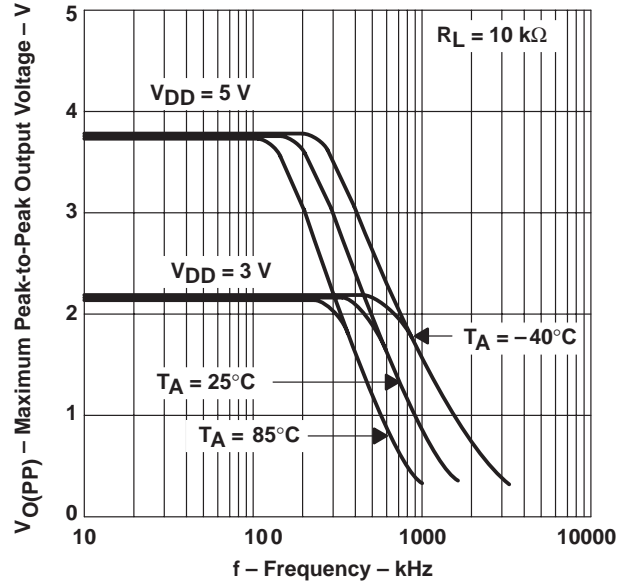

Figure 23

UNITY-GAIN BANDWIDTH  
 vs  
 FREE-AIR TEMPERATURE

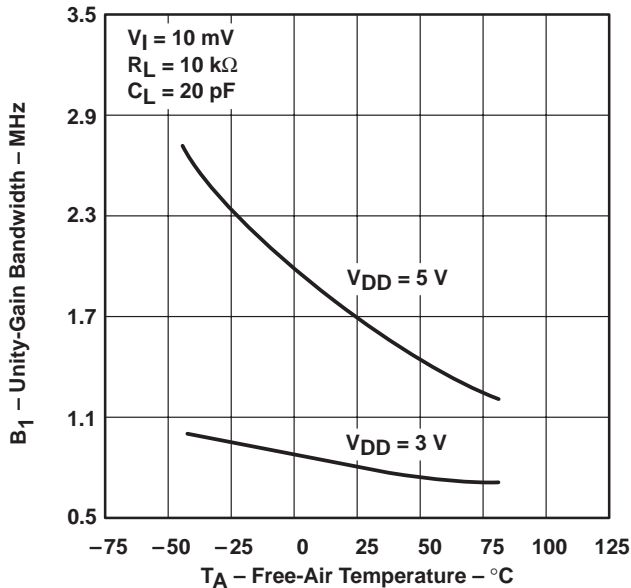

Figure 24

UNITY-GAIN BANDWIDTH  
 vs  
 SUPPLY VOLTAGE

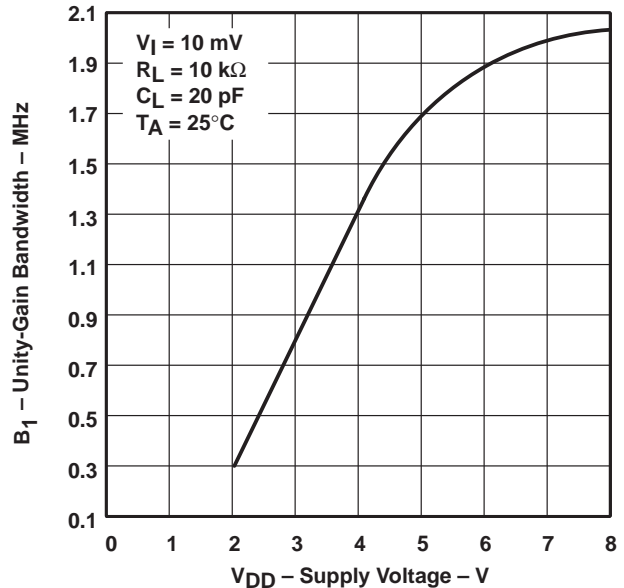
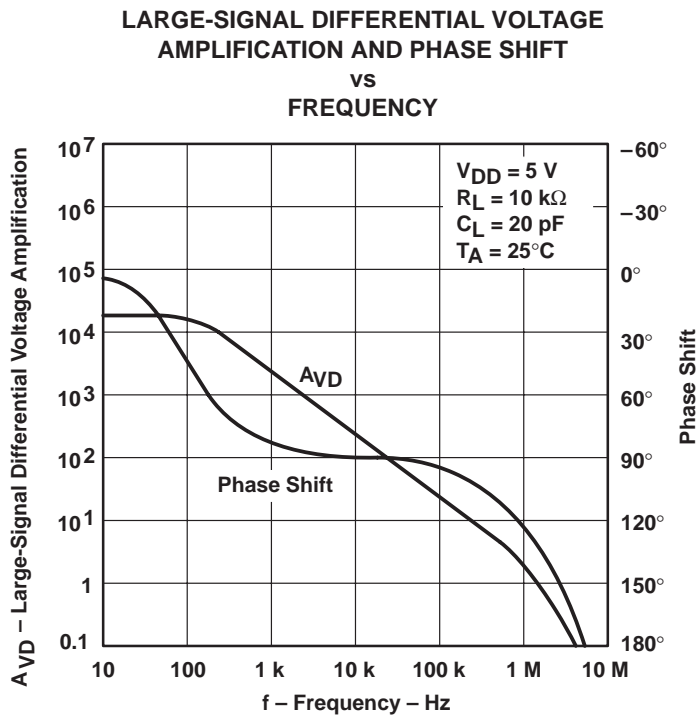
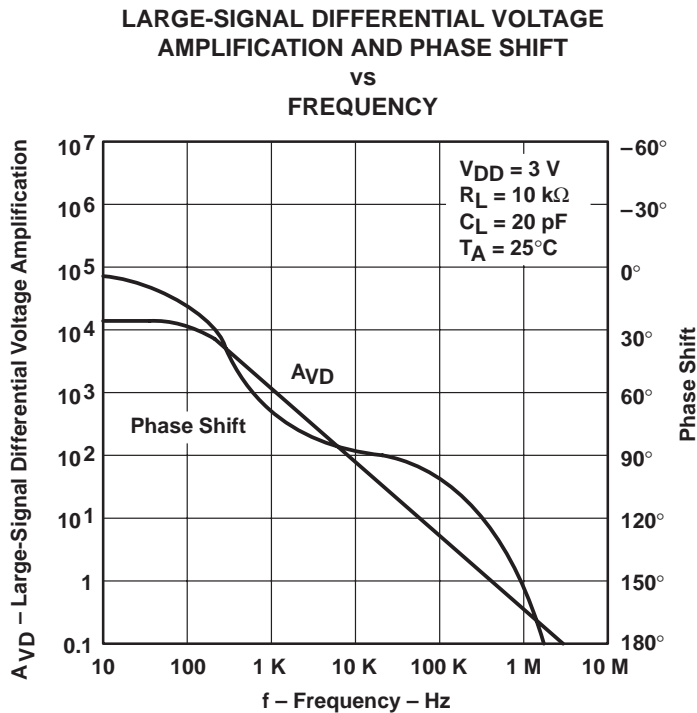

Figure 25



**TYPICAL CHARACTERISTICS (HIGH-BIAS MODE)**



TYPICAL CHARACTERISTICS (HIGH-BIAS MODE)

PHASE MARGIN  
 VS  
 SUPPLY VOLTAGE

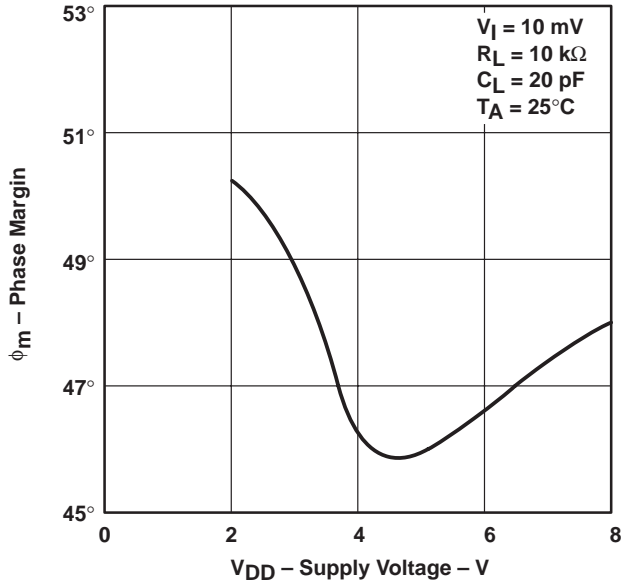

Figure 28

PHASE MARGIN  
 VS  
 FREE-AIR TEMPERATURE

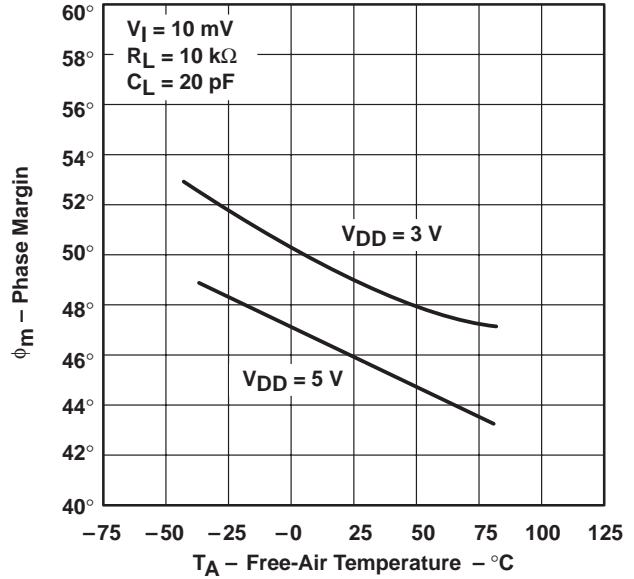

Figure 29

PHASE MARGIN  
 VS  
 LOAD CAPACITANCE

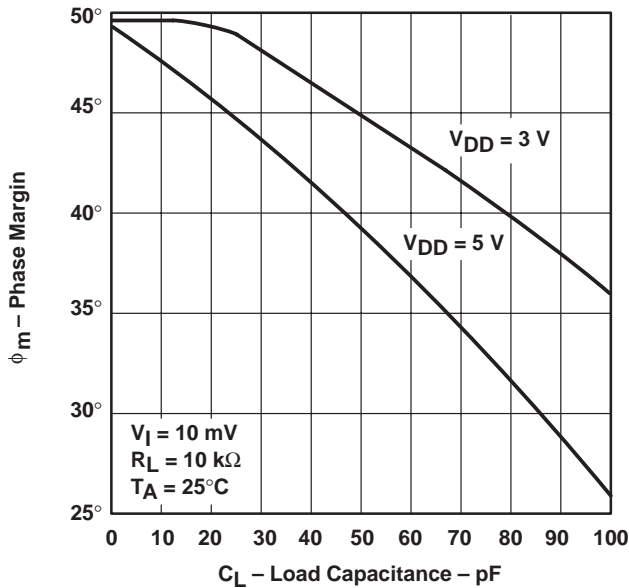

Figure 30

EQUIVALENT INPUT NOISE VOLTAGE  
 VS  
 FREQUENCY

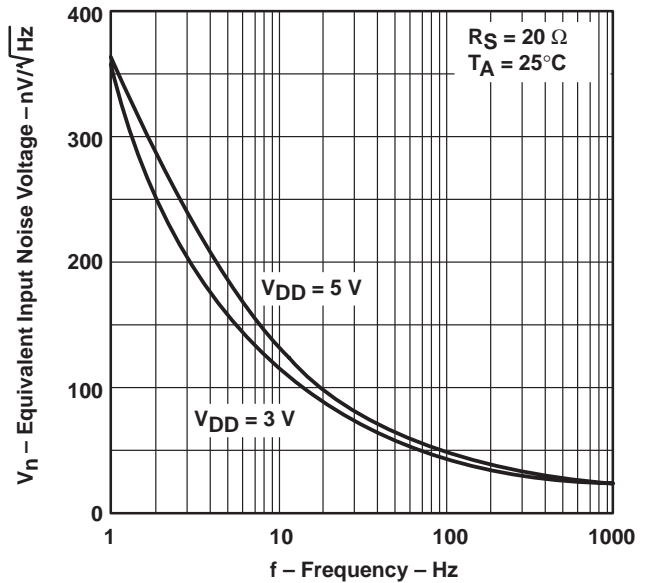

Figure 31

### MEDIUM-BIAS MODE

#### electrical characteristics at specified free-air temperature

| PARAMETER   | TEST CONDITIONS  | T <sub>A</sub> † | TLV2341I              |                   |     |                       |                   |     | UNIT  |
|---|--|------------------|-----------------------|-------------------|-----|-----------------------|-------------------|-----|-------|
|   |  |                  | V <sub>DD</sub> = 3 V |                   |     | V <sub>DD</sub> = 5 V |                   |     |       |
|   |  |                  | MIN                   | TYP               | MAX | MIN                   | TYP               | MAX |       |
| V <sub>IO</sub> Input offset voltage  | V <sub>O</sub> = 1 V,<br>V <sub>IC</sub> = 1 V,<br>R <sub>S</sub> = 50 Ω,<br>R <sub>L</sub> = 100 kΩ | 25°C             | 0.6                   |                   | 8   | 1.1                   |                   | 8   | mV    |
|   |  | Full range       |                       |                   | 10  |                       |                   | 10  |       |
| α <sub>VIO</sub> Average temperature coefficient of input offset voltage              |  | 25°C to 85°C     | 1                     |                   |     | 1.7                   |                   |     | μV/°C |
| I <sub>IO</sub> Input offset current (see Note 4)                                     | V <sub>O</sub> = 1 V,<br>V <sub>IC</sub> = 1 V   | 25°C             | 0.1                   |                   |     | 0.1                   |                   |     | pA    |
|   |  | 85°C             | 22                    | 1000              |     | 24                    | 1000              |     |       |
| I <sub>IB</sub> Input bias current (see Note 4)                                       | V <sub>O</sub> = 1 V,<br>V <sub>IC</sub> = 1 V   | 25°C             | 0.6                   |                   |     | 0.6                   |                   |     | pA    |
|   |  | 85°C             | 175                   | 2000              |     | 200                   | 2000              |     |       |
| V <sub>ICR</sub> Common-mode input voltage range (see Note 5)                         |  | 25°C             | -0.2<br>to<br>2       | -0.3<br>to<br>2.3 |     | -0.2<br>to<br>4       | -0.3<br>to<br>4.2 |     | V     |
|   |  | Full range       | -0.2<br>to<br>1.8     |                   |     | -0.2<br>to<br>3.8     |                   |     | V     |
| V <sub>OH</sub> High-level output voltage   | V <sub>IC</sub> = 1 V,<br>V <sub>ID</sub> = 100 mV,<br>I <sub>OH</sub> = -1 mA                       | 25°C             | 1.75                  | 1.9               |     | 3.2                   | 3.9               |     | V     |
|   |  | Full range       | 1.7                   |                   |     | 3                     |                   |     |       |
| V <sub>OL</sub> Low-level output voltage  | V <sub>IC</sub> = 1 V,<br>V <sub>ID</sub> = -100 mV,<br>I <sub>OL</sub> = 1 mA                       | 25°C             | 115                   |                   | 150 | 95                    |                   | 150 | mV    |
|   |  | Full range       |                       |                   | 190 |                       |                   | 190 |       |
| A <sub>VD</sub> Large-signal differential voltage amplification                       | V <sub>IC</sub> = 1 V,<br>R <sub>L</sub> = 100 kΩ,<br>See Note 6                                     | 25°C             | 25                    | 83                |     | 25                    | 170               |     | V/mV  |
|   |  | Full range       | 15                    |                   |     | 15                    |                   |     |       |
| CMRR Common-mode rejection ratio  | V <sub>O</sub> = 1 V,<br>V <sub>IC</sub> = V <sub>ICRmin</sub> ,<br>R <sub>S</sub> = 50 Ω            | 25°C             | 65                    | 92                |     | 65                    | 91                |     | dB    |
|   |  | Full range       | 60                    |                   |     | 60                    |                   |     |       |
| k <sub>SVR</sub> Supply-voltage rejection ratio (ΔV <sub>DD</sub> /ΔV <sub>IO</sub> ) | V <sub>IC</sub> = 1 V,<br>V <sub>O</sub> = 1 V,<br>R <sub>S</sub> = 50 Ω                             | 25°C             | 70                    | 94                |     | 70                    | 94                |     | dB    |
|   |  | Full range       | 65                    |                   |     | 65                    |                   |     |       |
| I <sub>I(SEL)</sub> Bias select current   | V <sub>I(SEL)</sub> = 0  | 25°C             | -100                  |                   |     | -130                  |                   |     | nA    |
| I <sub>DD</sub> Supply current  | V <sub>O</sub> = 1 V,<br>V <sub>IC</sub> = 1 V,<br>No load   | 25°C             | 65                    |                   | 250 | 105                   |                   | 280 | μA    |
|   |  | Full range       |                       |                   | 360 |                       |                   | 400 |       |

† Full range is -40°C to 85°C.

NOTES: 4. The typical values of input bias current and input offset current below 5 pA are determined mathematically.

5. This range also applies to each input individually.

6. At V<sub>DD</sub> = 5 V, V<sub>O</sub> = 0.25 V to 2 V; at V<sub>DD</sub> = 3 V, V<sub>O</sub> = 0.5 V to 1.5 V.

**TLV2341, TLV2341Y**  
**LinCMOS™ PROGRAMMABLE LOW-VOLTAGE**  
**OPERATIONAL AMPLIFIERS**

SLOS110A – MAY 1992 – REVISED AUGUST 1994

**MEDIUM-BIAS MODE**

**operating characteristics at specified free-air temperature,  $V_{DD} = 3\text{ V}$**

| PARAMETER                            | TEST CONDITIONS  | $T_A$  | TLV2341I |      |                              | UNIT                   |
|--------------------------------------|--|--|----------|------|------------------------------|------------------------|
|                                      |  |  | MIN      | TYP  | MAX                          |                        |
| SR Slew rate at unity gain           | $V_{IC} = 1\text{ V}$ ,<br>$R_L = 100\text{ k}\Omega$ ,<br>See Figure 92 | $V_{I(PP)} = 1\text{ V}$ ,<br>$C_L = 20\text{ pF}$   | 25°C     | 0.38 |                              | $\text{V}/\mu\text{s}$ |
|                                      |  |  | 85°C     | 0.29 |                              |                        |
| $V_n$ Equivalent input noise voltage | $f = \text{kHz}$ ,<br>See Figure 93                                      | $R_S = 20\ \Omega$ ,<br>25°C                         | 32       |      | $\text{nV}/\sqrt{\text{Hz}}$ |                        |
| BOM Maximum output-swing bandwidth   | $V_O = V_{OH}$ ,<br>$R_L = 100\text{ k}\Omega$ ,<br>See Figure 92        | 25°C   | 34       |      | kHz                          |                        |
|                                      |  | 85°C   | 32       |      |                              |                        |
| B <sub>1</sub> Unity-gain bandwidth  | $V_I = 10\text{ mV}$ ,<br>$R_L = 100\text{ k}\Omega$ ,<br>See Figure 94  | 25°C   | 300      |      | kHz                          |                        |
|                                      |  | 85°C   | 235      |      |                              |                        |
| $\phi_m$ Phase margin                | $V_I = 10\text{ mV}$ ,<br>$C_L = 20\text{ pF}$ ,<br>See Figure 94        | $f = B_1$ ,<br>$R_L = 100\text{ k}\Omega$ ,<br>-40°C | 42°      |      |                              |                        |
|                                      |  | 25°C   | 39°      |      |                              |                        |
|                                      |  | 85°C   | 36°      |      |                              |                        |

**operating characteristics at specified free-air temperature,  $V_{DD} = 5\text{ V}$**

| PARAMETER                            | TEST CONDITIONS  | $T_A$  | TLV2341I |      |                              | UNIT                   |
|--------------------------------------|--|--|----------|------|------------------------------|------------------------|
|                                      |  |  | MIN      | TYP  | MAX                          |                        |
| SR Slew rate at unity gain           | $V_{IC} = 1\text{ V}$ ,<br>$R_L = 100\text{ k}\Omega$ ,<br>$C_L = 20\text{ pF}$ ,<br>See Figure 92 | $V_{I(PP)} = 1\text{ V}$                             | 25°C     | 0.43 |                              | $\text{V}/\mu\text{s}$ |
|                                      |  |  | 85°C     | 0.35 |                              |                        |
|                                      |  | $V_{I(PP)} = 2.5\text{ V}$                           | 25°C     | 0.40 |                              |                        |
|                                      |  |  | 85°C     | 0.32 |                              |                        |
| $V_n$ Equivalent input noise voltage | $f = 1\text{ kHz}$ ,<br>See Figure 93  | $R_S = 20\ \Omega$ ,<br>25°C                         | 32       |      | $\text{nV}/\sqrt{\text{Hz}}$ |                        |
| BOM Maximum output-swing bandwidth   | $V_O = V_{OH}$ ,<br>$R_L = 100\text{ k}\Omega$ ,<br>See Figure 92                                  | 25°C   | 55       |      | kHz                          |                        |
|                                      |  | 85°C   | 45       |      |                              |                        |
| B <sub>1</sub> Unity-gain bandwidth  | $V_I = 10\text{ mV}$ ,<br>$R_L = 100\text{ k}\Omega$ ,<br>See Figure 94                            | 25°C   | 525      |      | kHz                          |                        |
|                                      |  | 85°C   | 370      |      |                              |                        |
| $\phi_m$ Phase margin                | $V_I = 10\text{ mV}$ ,<br>$C_L = 20\text{ pF}$ ,<br>See Figure 94                                  | $f = B_1$ ,<br>$R_L = 100\text{ k}\Omega$ ,<br>-40°C | 43°      |      |                              |                        |
|                                      |  | 25°C   | 40°      |      |                              |                        |
|                                      |  | 85°C   | 38°      |      |                              |                        |



**MEDIUM-BIAS MODE**

electrical characteristics,  $T_A = 25^\circ\text{C}$

| PARAMETER  | TEST CONDITIONS   | TLV2341I              |                   |     |                       |                   |     | UNIT          |
|--|---|-----------------------|-------------------|-----|-----------------------|-------------------|-----|---------------|
|  |   | $V_{DD} = 3\text{ V}$ |                   |     | $V_{DD} = 5\text{ V}$ |                   |     |               |
|  |   | MIN                   | TYP               | MAX | MIN                   | TYP               | MAX |               |
| $V_{IO}$ Input offset voltage  | $V_O = 1\text{ V}$ ,<br>$R_S = 50\ \Omega$ ,<br>$V_{IC} = 1\text{ V}$ ,<br>$R_L = 100\text{ k}\Omega$ |                       | 0.6               | 8   |                       | 1.1               | 8   | mV            |
| $I_{IO}$ Input offset current (see Note 4)                                 | $V_O = 1\text{ V}$ ,<br>$V_{IC} = 1\text{ V}$   |                       | 0.1               |     |                       | 0.1               |     | pA            |
| $I_{IB}$ Input bias current (see Note 4)                                   | $V_O = 1\text{ V}$ ,<br>$V_{IC} = 1\text{ V}$   |                       | 0.6               |     |                       | 0.6               |     | pA            |
| $V_{ICR}$ Common-mode input voltage range (see Note 5)                     |   | -0.2<br>to<br>2       | -0.3<br>to<br>2.3 |     | -0.2<br>to<br>4       | -0.3<br>to<br>4.2 |     | V             |
| $V_{OH}$ High-level output voltage   | $V_{IC} = 1\text{ V}$ ,<br>$I_{OH} = -1\text{ mA}$ ,<br>$V_{ID} = 100\text{ mV}$                      | 1.75                  | 1.9               |     | 3.2                   | 3.9               |     | V             |
| $V_{OL}$ Low-level output voltage  | $V_{IC} = 1\text{ V}$ ,<br>$I_{OL} = 1\text{ mA}$ ,<br>$V_{ID} = -100\text{ mV}$                      |                       | 115               | 150 |                       | 95                | 150 | mV            |
| $A_{VD}$ Large-signal differential voltage amplification                   | $V_{IC} = 1\text{ V}$ ,<br>$R_L = 100\text{ k}\Omega$ ,<br>See Note 6                                 | 25                    | 83                |     | 25                    | 170               |     | V/mV          |
| CMRR Common-mode rejection ratio   | $V_O = 1\text{ V}$ ,<br>$R_S = 50\ \Omega$ ,<br>$V_{IC} = V_{ICRmin}$                                 | 65                    | 92                |     | 65                    | 91                |     | dB            |
| $k_{SVR}$ Supply-voltage rejection ratio ( $\Delta V_{DD}/\Delta V_{ID}$ ) | $V_O = 1\text{ V}$ ,<br>$R_S = 50\ \Omega$ ,<br>$V_{IC} = 1\text{ V}$                                 | 70                    | 94                |     | 70                    | 94                |     | dB            |
| $I_{I(SEL)}$ Bias select current   | $V_{I(SEL)} = 0$  |                       | -100              |     |                       | -130              |     | nA            |
| $I_{DD}$ Supply current  | $V_O = 1\text{ V}$ ,<br>No load,<br>$V_{IC} = 1\text{ V}$   |                       | 65                | 250 |                       | 105               | 280 | $\mu\text{A}$ |

- NOTES: 4. The typical values of input bias current and input offset current below 5 pA are determined mathematically.  
 5. This range also applies to each input individually.  
 6. At  $V_{DD} = 5\text{ V}$ ,  $V_O = 0.25\text{ V}$  to  $2\text{ V}$ ; at  $V_{DD} = 3\text{ V}$ ,  $V_O = 0.5\text{ V}$  to  $1.5\text{ V}$ .

**TYPICAL CHARACTERISTICS (MEDIUM-BIAS MODE)**

**Table of Graphs**

|                |   | <b>FIGURE</b>                 |        |
|----------------|---|-------------------------------|--------|
| $V_{IO}$       | Input offset voltage                            | Distribution                  | 32, 33 |
| $\alpha_{VIO}$ | Input offset voltage temperature coefficient    | Distribution                  | 34, 35 |
| $V_{OH}$       | High-level output voltage                       | vs Output current             | 36     |
|                |   | vs Supply voltage             | 37     |
|                |   | vs Temperature                | 38     |
| $V_{OL}$       | Low-level output voltage                        | vs Common-mode input voltage  | 39     |
|                |   | vs Temperature                | 40, 42 |
|                |   | vs Differential input voltage | 41     |
|                |   | vs Low-level output current   | 43     |
| $A_{VD}$       | Large-signal differential voltage amplification | vs Supply voltage             | 44     |
|                |   | vs Temperature                | 45     |
|                |   | vs Frequency                  | 56, 57 |
| $I_{IB}$       | Input bias current                              | vs Temperature                | 46     |
| $I_{IO}$       | Input offset current                            | vs Temperature                | 46     |
| $V_{IC}$       | Common-mode input voltage                       | vs Supply voltage             | 47     |
| $I_{DD}$       | Supply current                                  | vs Supply voltage             | 48     |
|                |   | vs Temperature                | 49     |
| SR             | Slew rate                                       | vs Supply voltage             | 50     |
|                |   | vs Temperature                | 51     |
|                | Bias select current                             | vs Supply current             | 52     |
| $V_{O(PP)}$    | Maximum peak-to-peak output voltage             | vs Frequency                  | 53     |
| $B_1$          | Unity-gain bandwidth                            | vs Temperature                | 54     |
|                |   | vs Supply voltage             | 55     |
| $\phi_m$       | Phase margin                                    | vs Supply voltage             | 58     |
|                |   | vs Temperature                | 59     |
|                |   | vs Load capacitance           | 60     |
| $V_n$          | Equivalent input noise voltage                  | vs Frequency                  | 61     |
|                |   | Phase shift                   | 56, 57 |

TYPICAL CHARACTERISTICS (MEDIUM-BIAS MODE)

DISTRIBUTION OF TLV2341  
 INPUT OFFSET VOLTAGE

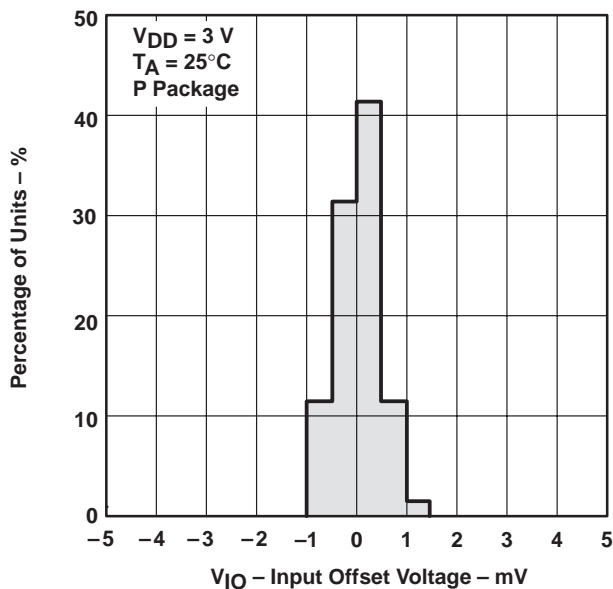

Figure 32

DISTRIBUTION OF TLV2341  
 INPUT OFFSET VOLTAGE

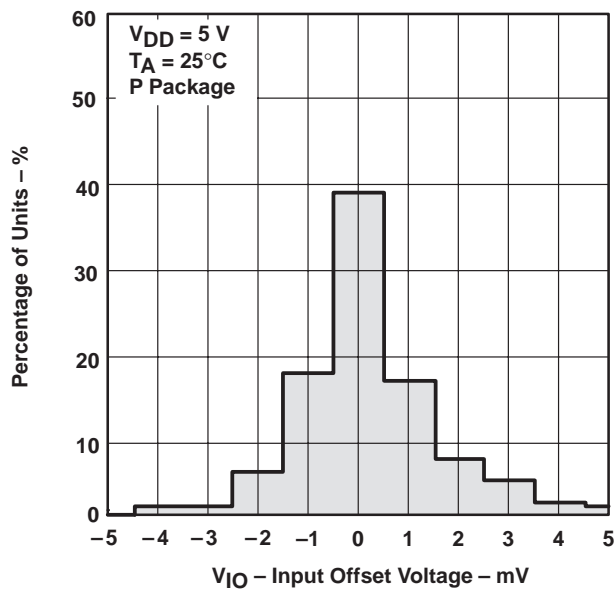

Figure 33

DISTRIBUTION OF TLV2341  
 INPUT OFFSET VOLTAGE  
 TEMPERATURE COEFFICIENT

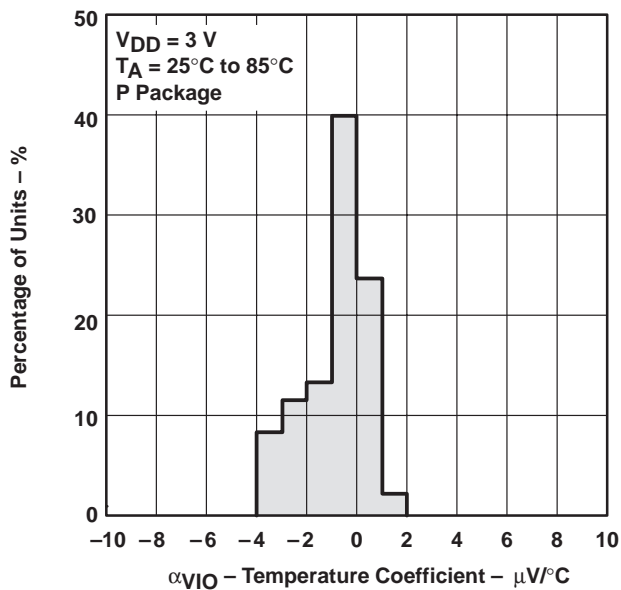

Figure 34

DISTRIBUTION OF TLV2341  
 INPUT OFFSET VOLTAGE  
 TEMPERATURE COEFFICIENT

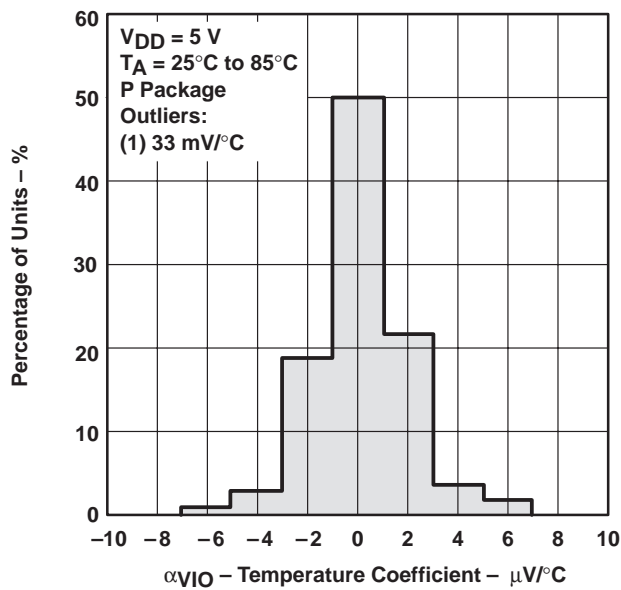

Figure 35

TYPICAL CHARACTERISTICS (MEDIUM-BIAS MODE)

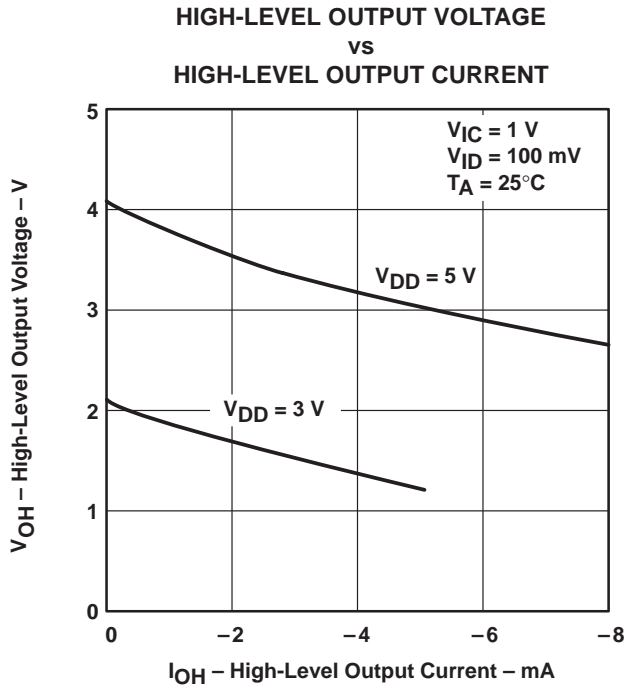

Figure 36

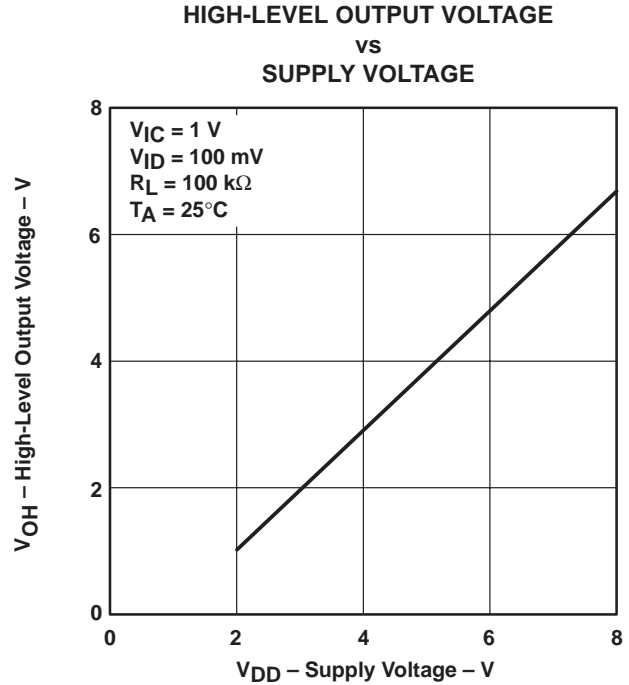

Figure 37

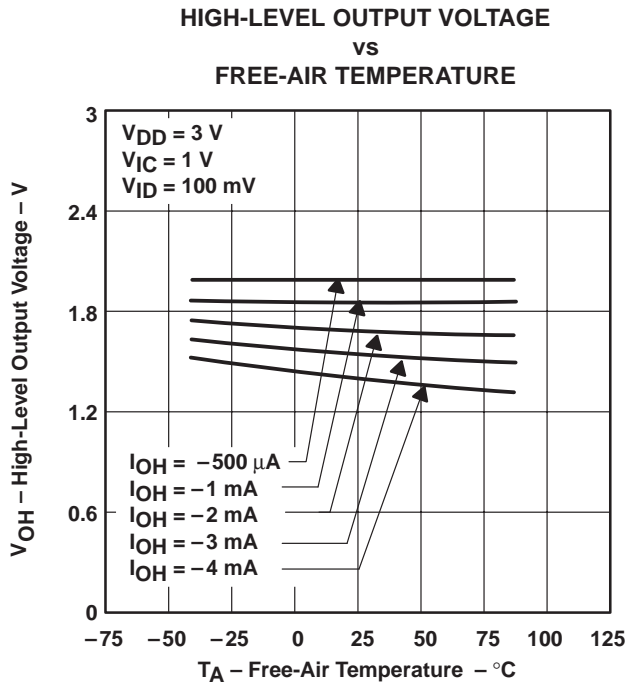

Figure 38

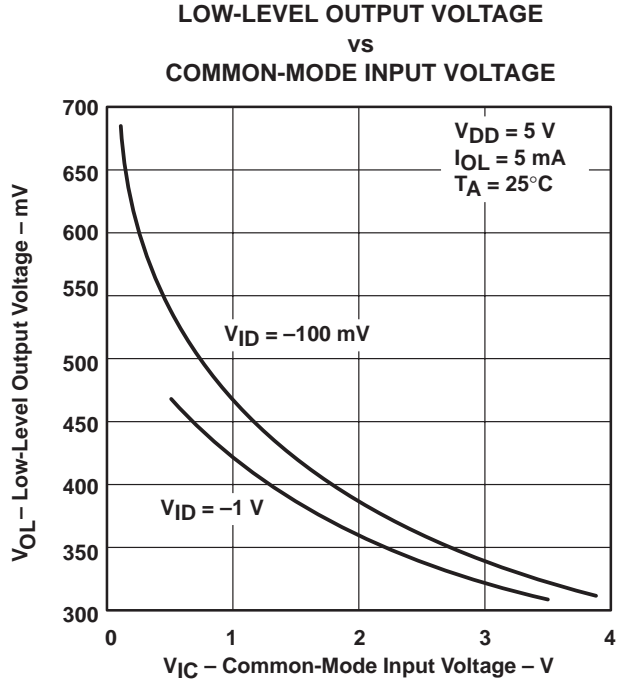

Figure 39



TYPICAL CHARACTERISTICS (MEDIUM-BIAS MODE)

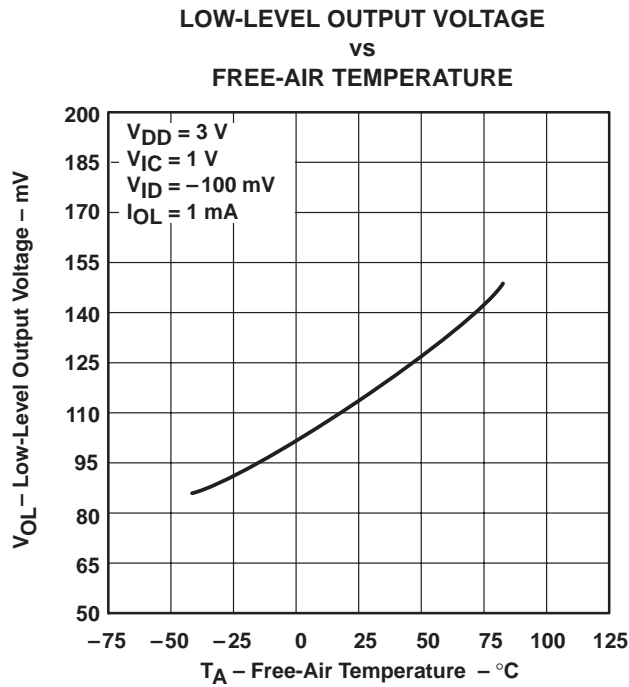

Figure 40

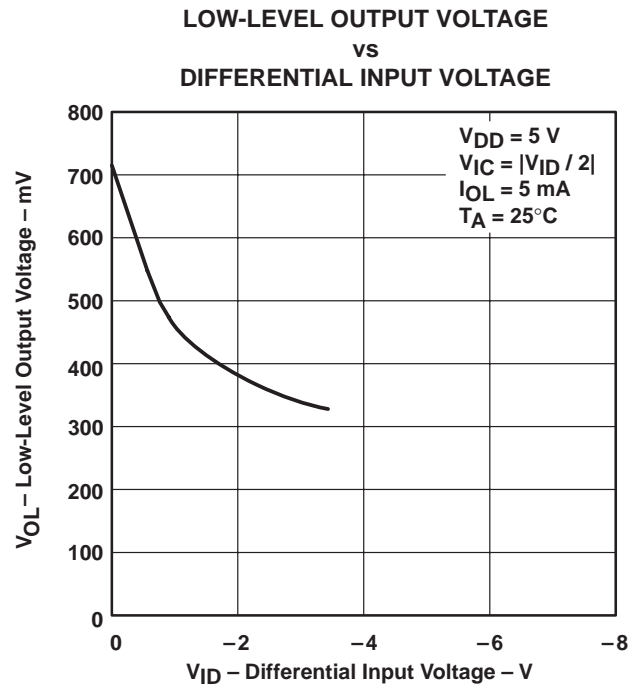

Figure 41

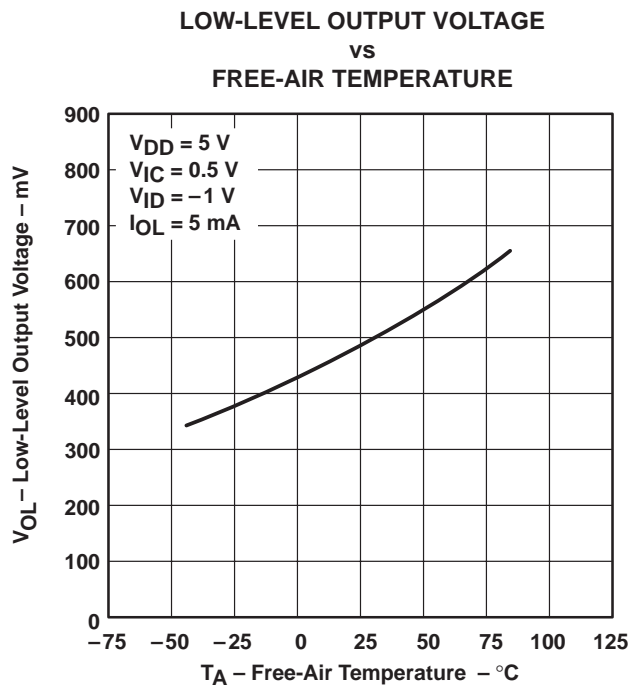

Figure 42

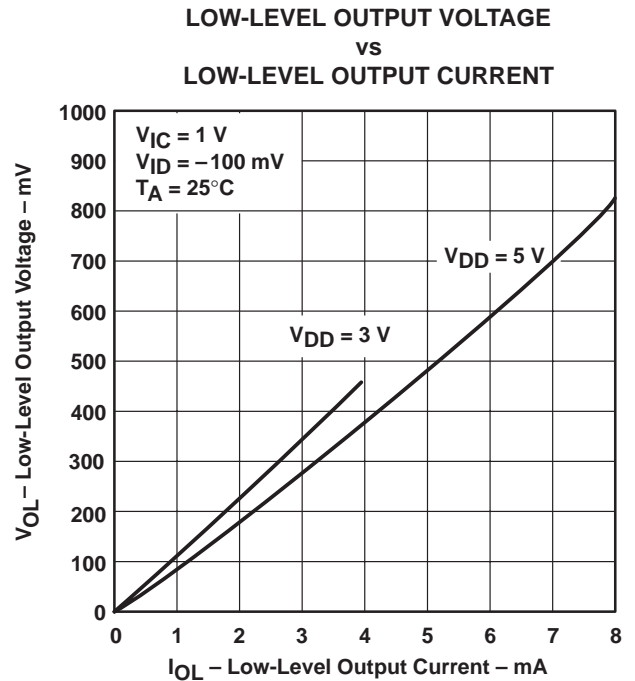
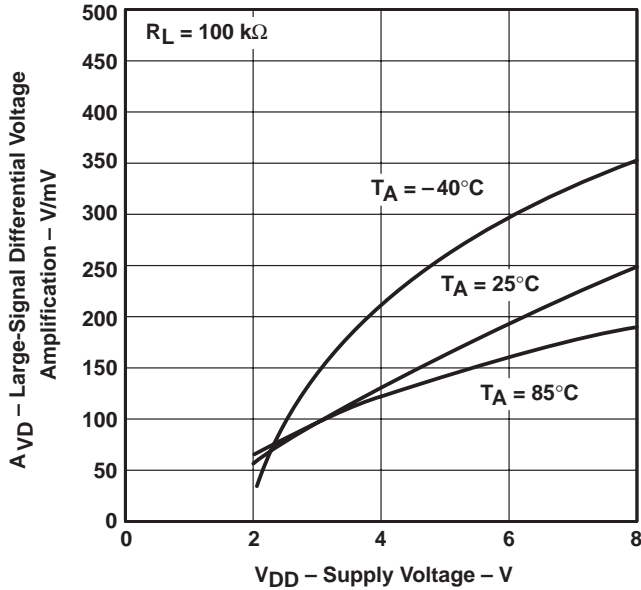

Figure 43

**TYPICAL CHARACTERISTICS (MEDIUM-BIAS MODE)**

**LARGE-SIGNAL  
 DIFFERENTIAL VOLTAGE AMPLIFICATION  
 vs  
 SUPPLY VOLTAGE**



**Figure 44**

**LARGE-SIGNAL  
 DIFFERENTIAL VOLTAGE AMPLIFICATION  
 vs  
 FREE-AIR TEMPERATURE**

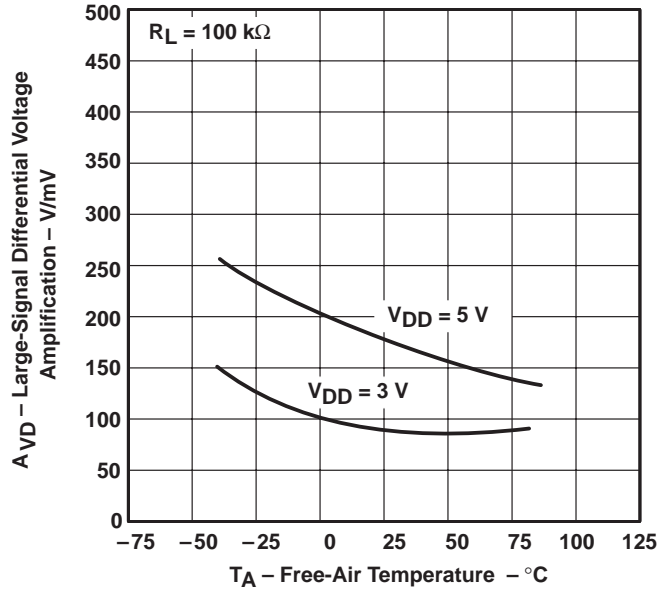

**Figure 45**

**INPUT BIAS CURRENT AND INPUT OFFSET CURRENT  
 vs  
 FREE-AIR TEMPERATURE**

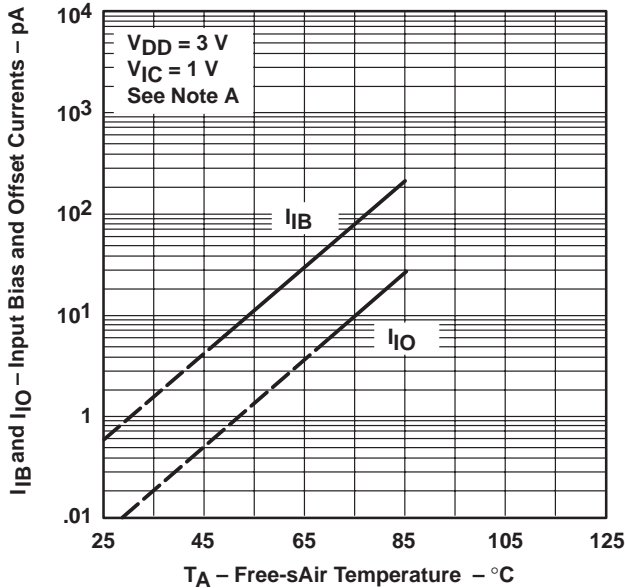

**Figure 46**

**COMMON-MODE INPUT VOLTAGE POSITIVE LIMIT  
 vs  
 SUPPLY VOLTAGE**

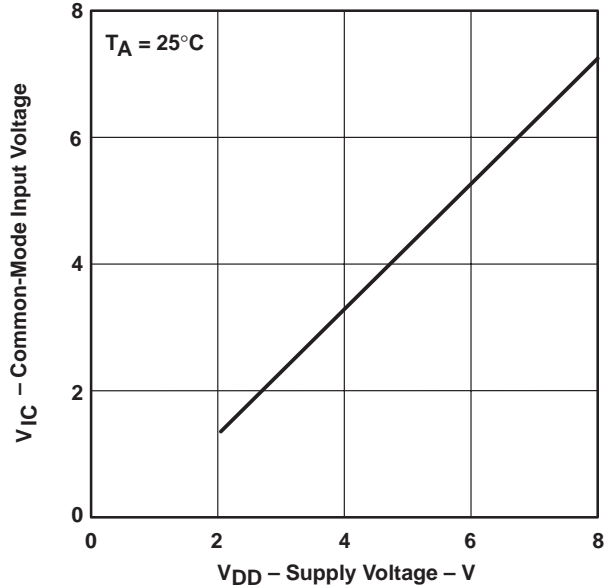

**Figure 47**

NOTE A: The typical values of input bias current and input offset current below 5 pA are determined mathematically.

TYPICAL CHARACTERISTICS (MEDIUM-BIAS MODE)

SUPPLY CURRENT  
 vs  
 SUPPLY VOLTAGE

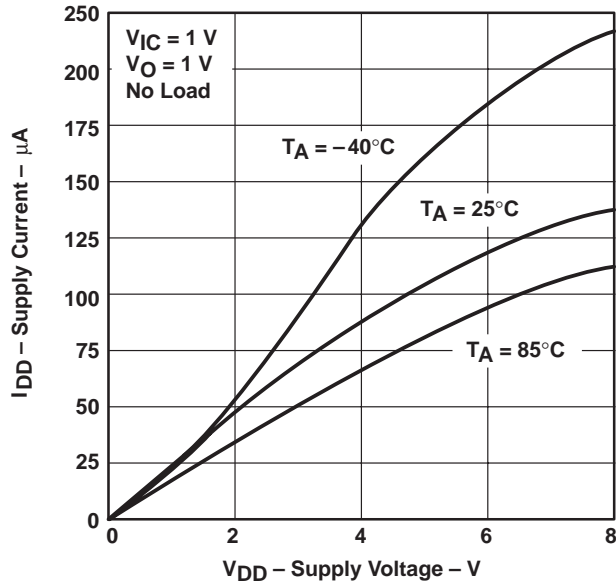

Figure 48

SUPPLY CURRENT  
 vs  
 FREE-AIR TEMPERATURE

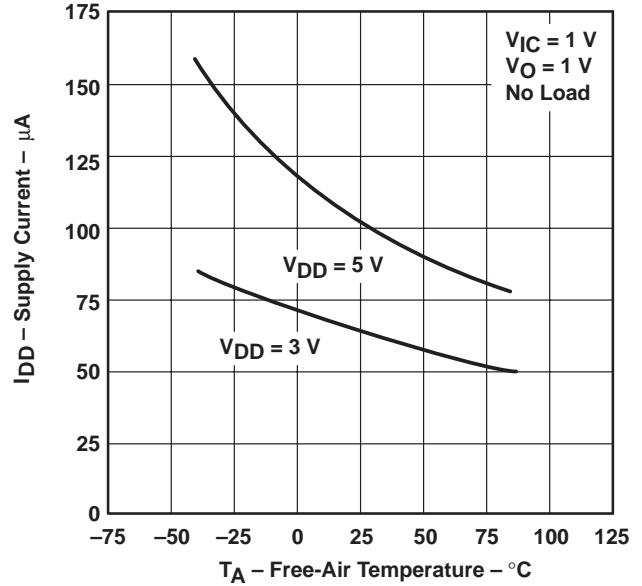

Figure 49

SLEW RATE  
 vs  
 SUPPLY VOLTAGE

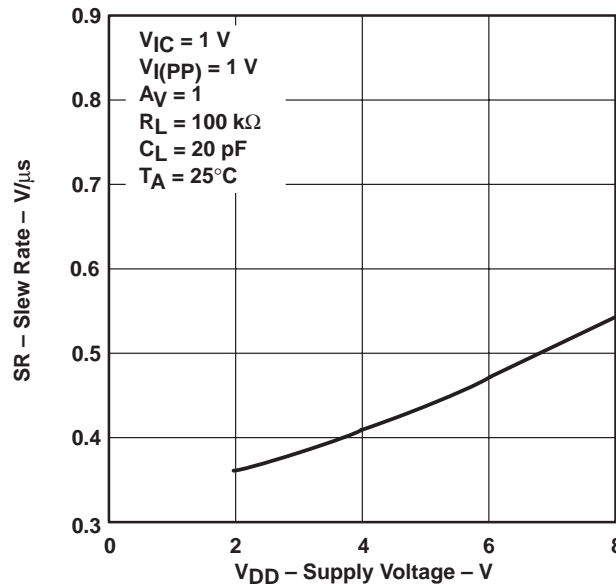

Figure 50

SLEW RATE  
 vs  
 FREE-AIR TEMPERATURE

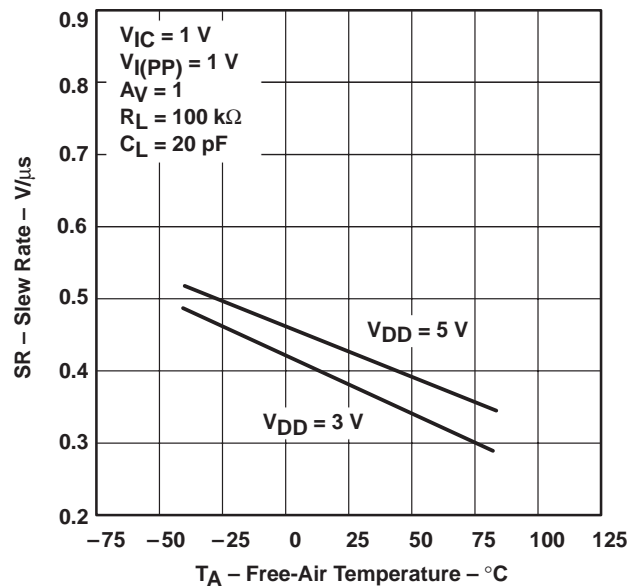
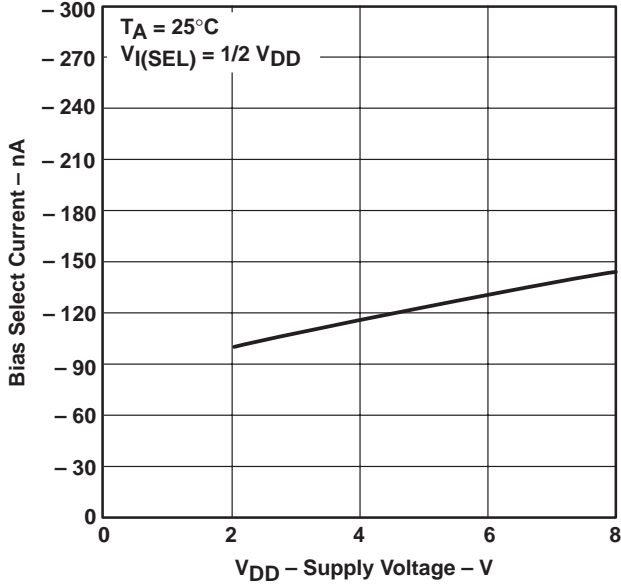

Figure 51

**TYPICAL CHARACTERISTICS (MEDIUM-BIAS MODE)**

**BIAS SELECT CURRENT  
 vs  
 SUPPLY VOLTAGE**



**Figure 52**

**MAXIMUM PEAK-TO-PEAK OUTPUT VOLTAGE  
 vs  
 FREQUENCY**

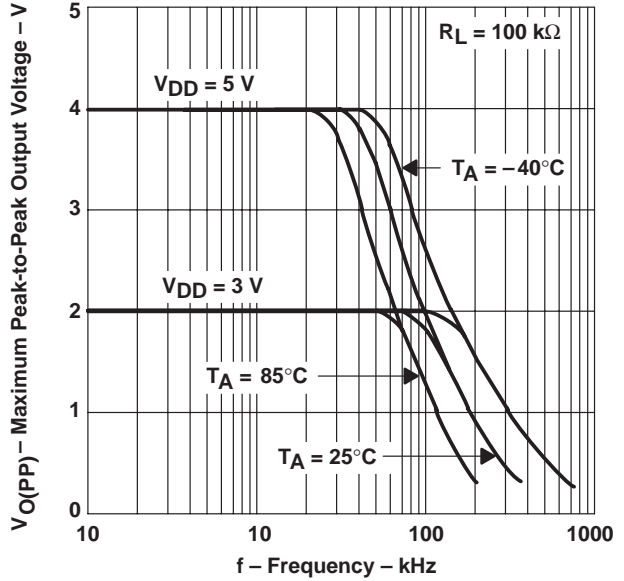

**Figure 53**

**UNITY-GAIN BANDWIDTH  
 vs  
 FREE-AIR TEMPERATURE**

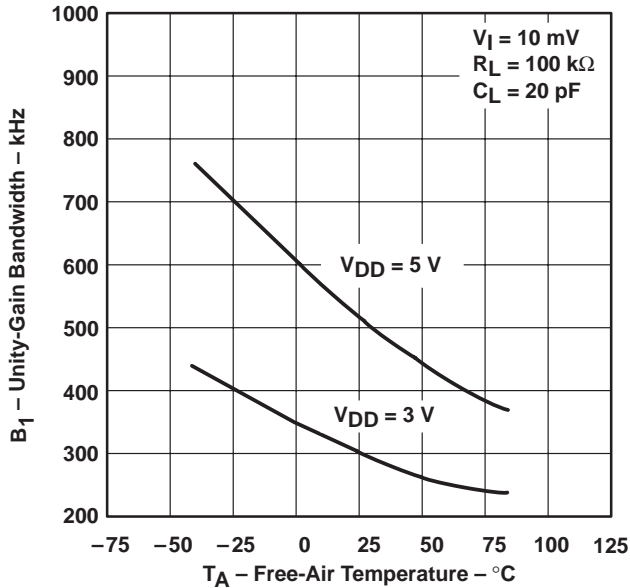

**Figure 54**

**UNITY-GAIN BANDWIDTH  
 vs  
 SUPPLY VOLTAGE**

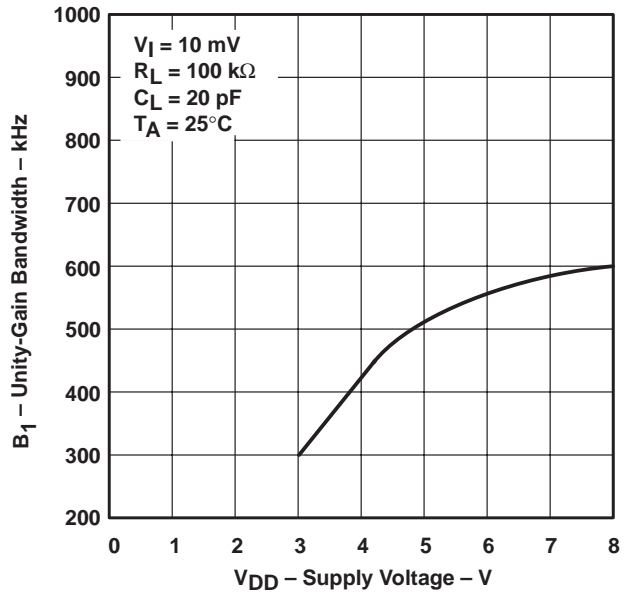

**Figure 55**

TYPICAL CHARACTERISTICS (MEDIUM-BIAS MODE)

LARGE-SIGNAL DIFFERENTIAL VOLTAGE  
 AMPLIFICATION AND PHASE SHIFT  
 vs  
 FREQUENCY

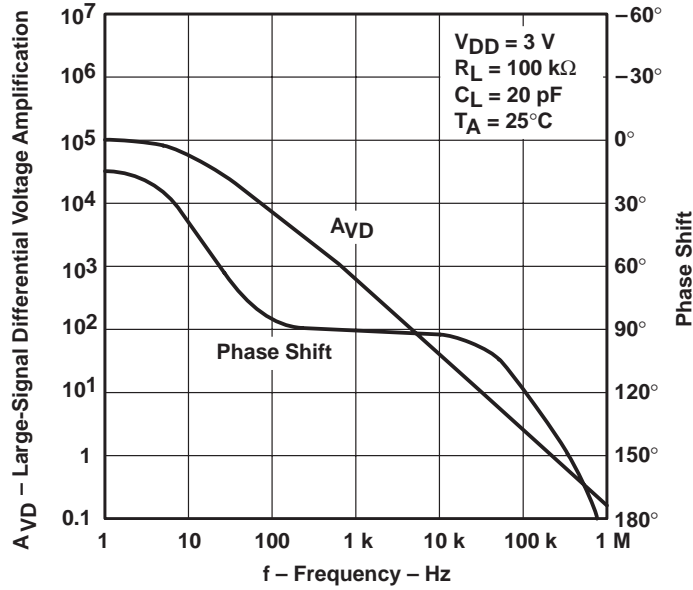

Figure 56

LARGE-SIGNAL DIFFERENTIAL VOLTAGE  
 AMPLIFICATION AND PHASE SHIFT  
 vs  
 FREQUENCY

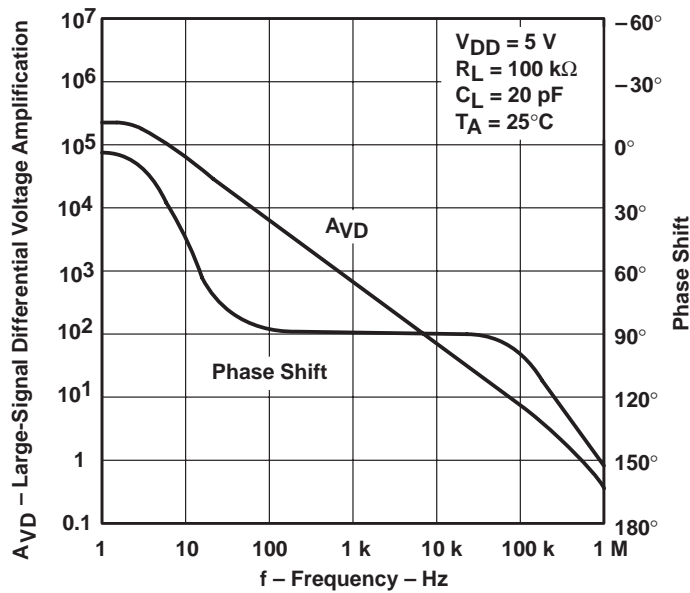
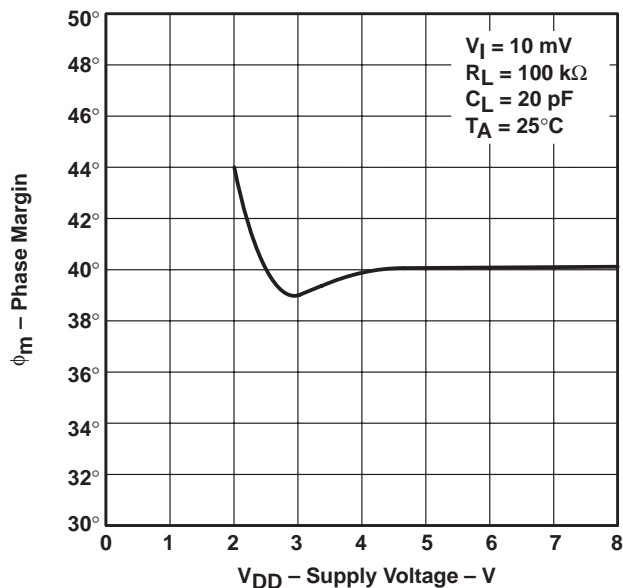

Figure 57

**TYPICAL CHARACTERISTICS (MEDIUM-BIAS MODE)**

**PHASE MARGIN  
 vs  
 SUPPLY VOLTAGE**



**Figure 58**

**PHASE MARGIN  
 vs  
 FREE-AIR TEMPERATURE**

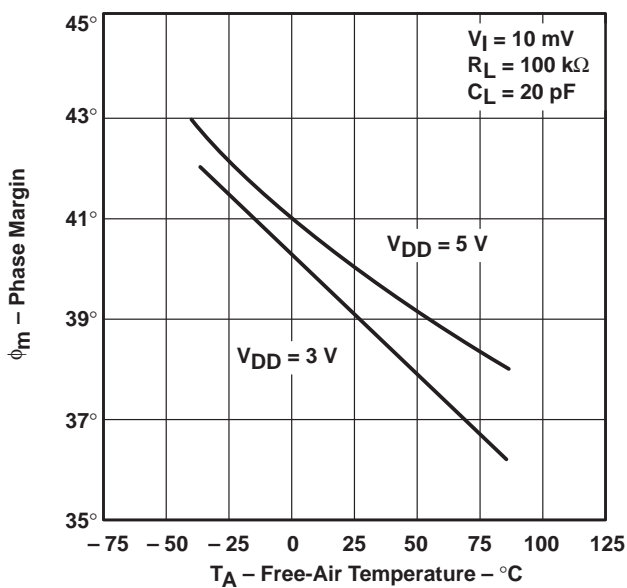

**Figure 59**

**PHASE MARGIN  
 vs  
 LOAD CAPACITANCE**

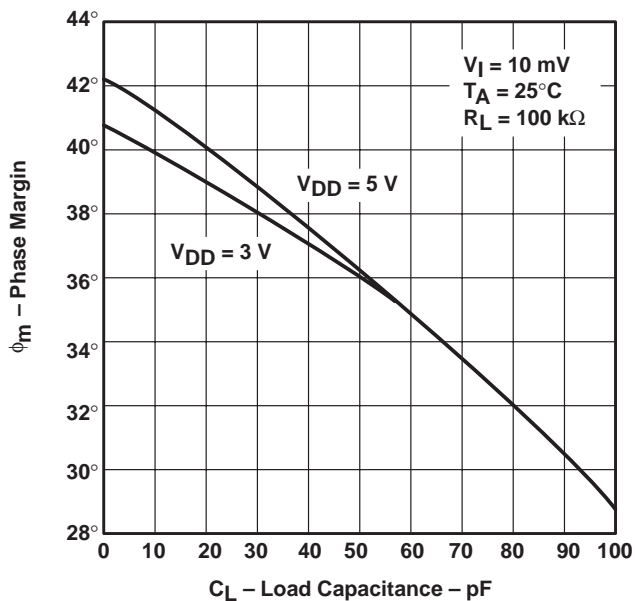

**Figure 60**

**EQUIVALENT INPUT NOISE VOLTAGE  
 vs  
 FREQUENCY**

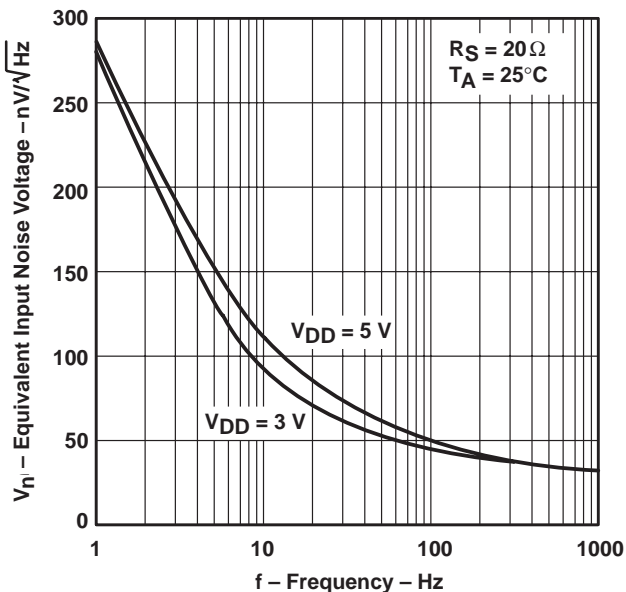

**Figure 61**

### LOW-BIAS MODE

#### electrical characteristics at specified free-air temperature

| PARAMETER   | TEST CONDITIONS  | T <sub>A</sub> † | TLV2341I              |                   |     |                       |                   |     | UNIT  |
|---|--|------------------|-----------------------|-------------------|-----|-----------------------|-------------------|-----|-------|
|   |  |                  | V <sub>DD</sub> = 3 V |                   |     | V <sub>DD</sub> = 5 V |                   |     |       |
|   |  |                  | MIN                   | TYP               | MAX | MIN                   | TYP               | MAX |       |
| V <sub>IO</sub> Input offset voltage  | V <sub>O</sub> = 1 V,<br>V <sub>IC</sub> = 1 V,<br>R <sub>S</sub> = 50 Ω,<br>R <sub>L</sub> = 1 MΩ | 25°C             | 0.6                   |                   | 8   | 1.1                   |                   | 8   | mV    |
|   |  | Full range       |                       |                   | 10  |                       |                   | 10  |       |
| α <sub>VIO</sub> Average temperature of input offset voltage                          |  | 25°C to 85°C     | 1                     |                   |     | 1.1                   |                   |     | μV/°C |
| I <sub>IO</sub> Input offset current (see Note 4)                                     | V <sub>O</sub> = 1 V,<br>V <sub>IC</sub> = 1 V   | 25°C             | 0.1                   |                   |     | 0.1                   |                   |     | pA    |
|   |  | 85°C             | 22                    | 1000              |     | 24                    | 1000              |     |       |
| I <sub>IB</sub> Input bias current (see Note 4)                                       | V <sub>O</sub> = 1 V,<br>V <sub>IC</sub> = 1 V   | 25°C             | 0.6                   |                   |     | 0.6                   |                   |     | pA    |
|   |  | 85°C             | 175                   | 2000              |     | 200                   | 2000              |     |       |
| V <sub>ICR</sub> Common-mode input voltage range (see Note 5)                         |  | 25°C             | -0.2<br>to<br>2       | -0.3<br>to<br>2.3 |     | -0.2<br>to<br>4       | -0.3<br>to<br>4.2 |     | V     |
|   |  | Full range       | -0.2<br>to<br>1.8     |                   |     | -0.2<br>to<br>3.8     |                   |     | V     |
| V <sub>OH</sub> High-level output voltage   | V <sub>IC</sub> = 1 V,<br>V <sub>ID</sub> = 100 mV,<br>I <sub>OH</sub> = -1 mA                     | 25°C             | 1.75                  | 1.9               |     | 3.2                   | 3.8               |     | V     |
|   |  | Full range       | 1.7                   |                   |     | 3                     |                   |     |       |
| V <sub>OL</sub> Low-level output voltage  | V <sub>IC</sub> = 1 V,<br>V <sub>ID</sub> = -100 mV,<br>I <sub>OL</sub> = 1 mA                     | 25°C             | 115                   |                   | 150 | 95                    |                   | 150 | mV    |
|   |  | Full range       |                       |                   | 190 |                       |                   | 190 |       |
| A <sub>VD</sub> Large-signal differential voltage amplification                       | V <sub>IC</sub> = 1 V,<br>R <sub>L</sub> = 1 MΩ,<br>See Note 6                                     | 25°C             | 50                    | 400               |     | 50                    | 520               |     | V/mV  |
|   |  | Full range       | 50                    |                   |     | 50                    |                   |     |       |
| CMRR Common-mode rejection ratio  | V <sub>O</sub> = 1 V,<br>V <sub>IC</sub> = V <sub>ICRmin</sub> ,<br>R <sub>S</sub> = 50 Ω          | 25°C             | 65                    | 88                |     | 65                    | 94                |     | dB    |
|   |  | Full range       | 60                    |                   |     | 60                    |                   |     |       |
| k <sub>SVR</sub> Supply-voltage rejection ratio (ΔV <sub>DD</sub> /ΔV <sub>IO</sub> ) | V <sub>IC</sub> = 1 V,<br>V <sub>O</sub> = 1 V,<br>R <sub>S</sub> = 50 Ω                           | 25°C             | 70                    | 86                |     | 70                    | 86                |     | dB    |
|   |  | Full range       | 65                    |                   |     | 65                    |                   |     |       |
| I <sub>I(SEL)</sub> Bias select current   | V <sub>I(SEL)</sub> = 0  | 25°C             | 10                    |                   |     | 65                    |                   |     | nA    |
| I <sub>DD</sub> Supply current  | V <sub>O</sub> = 1 V,<br>V <sub>IC</sub> = 1 V,<br>No load   | 25°C             | 5                     |                   | 17  | 10                    |                   | 17  | μA    |
|   |  | Full range       |                       |                   | 27  |                       |                   | 27  |       |

† Full range is -40°C to 85°C.

NOTES: 4. The typical values of input bias current and input offset current below 5 pA are determined mathematically.

5. This range also applies to each input individually.

6. At V<sub>DD</sub> = 5 V, V<sub>O(PP)</sub> = 0.25 V to 2 V; at V<sub>DD</sub> = 3 V, V<sub>O</sub> = 0.5 V to 1.5 V.

**TLV2341, TLV2341Y**  
**LinCMOS™ PROGRAMMABLE LOW-VOLTAGE**  
**OPERATIONAL AMPLIFIERS**

SLOS110A – MAY 1992 – REVISED AUGUST 1994

**LOW-BIAS MODE**

**operating characteristics at specified free-air temperature,  $V_{DD} = 3\text{ V}$**

| PARAMETER                            | TEST CONDITIONS  | $T_A$  | TLV2341I |     |     | UNIT                   |
|--------------------------------------|--|--|----------|-----|-----|------------------------|
|                                      |  |  | MIN      | TYP | MAX |                        |
| SR Slew rate at unity gain           | $V_{IC} = 1\text{ V}$ ,<br>$R_L = 1\text{ M}\Omega$ ,<br>See Figure 92 | $V_{I(PP)} = 1\text{ V}$ ,<br>$C_L = 20\text{ pF}$ ,<br>25°C | 0.02     |     |     | V/ $\mu\text{s}$       |
|                                      |  | 85°C   | 0.02     |     |     |                        |
| $V_n$ Equivalent input noise voltage | $f = \text{kHz}$ ,<br>See Figure 93                                    | $R_S = 20\ \Omega$ ,<br>25°C                                 | 68       |     |     | nV/ $\sqrt{\text{Hz}}$ |
| BOM Maximum output-swing bandwidth   | $V_O = V_{OH}$ ,<br>$R_L = 1\text{ M}\Omega$ ,<br>See Figure 92        | 25°C   | 2.5      |     |     | kHz                    |
|                                      |  | 85°C   | 2        |     |     |                        |
| B <sub>1</sub> Unity-gain bandwidth  | $V_I = 10\text{ mV}$ ,<br>$R_L = 1\text{ M}\Omega$ ,<br>See Figure 94  | 25°C   | 27       |     |     | kHz                    |
|                                      |  | 85°C   | 21       |     |     |                        |
| $\phi_m$ Phase margin                | $V_I = 10\text{ mV}$ ,<br>$C_L = 20\text{ pF}$ ,<br>See Figure 94      | $f = B_1$ ,<br>$R_L = 1\text{ M}\Omega$ ,<br>-40°C           | 39°      |     |     |                        |
|                                      |  | 25°C   | 34°      |     |     |                        |
|                                      |  | 85°C   | 28°      |     |     |                        |

**operating characteristics at specified free-air temperature,  $V_{DD} = 5\text{ V}$**

| PARAMETER                            | TEST CONDITIONS  | $T_A$  | TLV2341I |      |     | UNIT                   |                  |
|--------------------------------------|--|--|----------|------|-----|------------------------|------------------|
|                                      |  |  | MIN      | TYP  | MAX |                        |                  |
| SR Slew rate at unity gain           | $V_{IC} = 1\text{ V}$ ,<br>$R_L = 1\text{ M}\Omega$ ,<br>$C_L = 20\text{ pF}$ ,<br>See Figure 92 | $V_{I(PP)} = 1\text{ V}$                           | 25°C     | 0.03 |     |                        | V/ $\mu\text{s}$ |
|                                      |  |  | 85°C     | 0.03 |     |                        |                  |
|                                      |  | $V_{I(PP)} = 2.5\text{ V}$                         | 25°C     | 0.03 |     |                        |                  |
|                                      |  |  | 85°C     | 0.02 |     |                        |                  |
| $V_n$ Equivalent input noise voltage | $f = 1\text{ kHz}$ ,<br>See Figure 93  | $R_S = 20\ \Omega$ ,<br>25°C                       | 68       |      |     | nV/ $\sqrt{\text{Hz}}$ |                  |
| BOM Maximum output-swing bandwidth   | $V_O = V_{OH}$ ,<br>$R_L = 1\text{ M}\Omega$ ,<br>See Figure 92                                  | 25°C   | 5        |      |     | kHz                    |                  |
|                                      |  | 85°C   | 4        |      |     |                        |                  |
| B <sub>1</sub> Unity-gain bandwidth  | $V_I = 10\text{ mV}$ ,<br>$R_L = 1\text{ M}\Omega$ ,<br>See Figure 94                            | 25°C   | 85       |      |     | kHz                    |                  |
|                                      |  | 85°C   | 55       |      |     |                        |                  |
| $\phi_m$ Phase margin                | $V_I = 10\text{ mV}$ ,<br>$C_L = 20\text{ pF}$ ,<br>See Figure 94                                | $f = B_1$ ,<br>$R_L = 1\text{ M}\Omega$ ,<br>-40°C | 38°      |      |     |                        |                  |
|                                      |  | 25°C   | 34°      |      |     |                        |                  |
|                                      |  | 85°C   | 28°      |      |     |                        |                  |





**LOW-BIAS MODE**

electrical characteristics,  $T_A = 25^\circ\text{C}$

| PARAMETER           | TEST CONDITIONS  | TLV2341Y              |                   |     |                       |                   |     | UNIT |
|---------------------|--|-----------------------|-------------------|-----|-----------------------|-------------------|-----|------|
|                     |  | V <sub>DD</sub> = 3 V |                   |     | V <sub>DD</sub> = 5 V |                   |     |      |
|                     |  | MIN                   | TYP               | MAX | MIN                   | TYP               | MAX |      |
| V <sub>IO</sub>     | Input offset voltage<br>V <sub>O</sub> = 1 V,<br>R <sub>S</sub> = 50 Ω, V <sub>IC</sub> = 1 V,<br>R <sub>L</sub> = 1 MΩ  |                       | 0.6               | 8   |                       | 1.1               | 8   | mV   |
| I <sub>IO</sub>     | Input offset current<br>(see Note 4)<br>V <sub>O</sub> = 1 V, V <sub>IC</sub> = 1 V  |                       | 0.1               |     |                       | 0.1               |     | pA   |
| I <sub>IB</sub>     | Input bias current<br>(see Note 4)<br>V <sub>O</sub> = 1 V, V <sub>IC</sub> = 1 V  |                       | 0.6               |     |                       | 0.6               |     | pA   |
| V <sub>ICR</sub>    | Common-mode input voltage<br>range (see Note 5)  | -0.2<br>to<br>2       | -0.3<br>to<br>2.3 |     | -0.2<br>to<br>4       | -0.3<br>to<br>4.2 |     | V    |
| V <sub>OH</sub>     | High-level output voltage<br>V <sub>IC</sub> = 1 V, I <sub>OH</sub> = -1 mA, V <sub>ID</sub> = 100 mV,   | 1.75                  | 1.9               |     | 3.2                   | 3.8               |     | V    |
| V <sub>OL</sub>     | Low-level output voltage<br>V <sub>IC</sub> = 1 V, I <sub>OL</sub> = 1 mA, V <sub>ID</sub> = -100 mV,  |                       | 115               | 150 |                       | 95                | 150 | mV   |
| A <sub>VD</sub>     | Large-signal differential<br>voltage amplification<br>V <sub>IC</sub> = 1 V, See Note 6, R <sub>L</sub> = 1 MΩ,  | 50                    | 400               |     | 50                    | 520               |     | V/mV |
| CMRR                | Common-mode rejection ratio<br>V <sub>O</sub> = 1 V, R <sub>S</sub> = 50 Ω, V <sub>IC</sub> = V <sub>ICRmin</sub> ,  | 65                    | 88                |     | 65                    | 94                |     | dB   |
| k <sub>SVR</sub>    | Supply-voltage rejection ratio<br>(ΔV <sub>DD</sub> /ΔV <sub>ID</sub> )<br>V <sub>DD</sub> = 3 V to 5 V, V <sub>O</sub> = 1 V, V <sub>IC</sub> = 1 V,<br>R <sub>S</sub> = 50 Ω | 70                    | 86                |     | 70                    | 86                |     | dB   |
| I <sub>I(SEL)</sub> | Bias select current<br>V <sub>I(SEL)</sub> = 0   |                       | 10                |     |                       | 65                |     | nA   |
| I <sub>DD</sub>     | Supply current<br>V <sub>O</sub> = 1 V, No load, V <sub>IC</sub> = 1 V,  |                       | 5                 | 17  |                       | 10                | 17  | μA   |

- NOTES: 4. The typical values of input bias current and input offset current below 5 pA are determined mathematically.  
 5. This range also applies to each input individually.  
 6. At V<sub>DD</sub> = 5 V, V<sub>O</sub> = 0.25 V to 2 V; at V<sub>DD</sub> = 3 V, V<sub>O</sub> = 0.5 V to 1.5 V.

**TYPICAL CHARACTERISTICS (LOW-BIAS MODE)**

**Table of Graphs**

|                |   | <b>FIGURE</b>                 |        |
|----------------|---|-------------------------------|--------|
| $V_{IO}$       | Input offset voltage                            | Distribution                  | 62, 63 |
| $\alpha_{VIO}$ | Input offset voltage temperature coefficient    | Distribution                  | 64, 65 |
| $V_{OH}$       | High-level output voltage                       | vs Output current             | 66     |
|                |   | vs Supply voltage             | 67     |
|                |   | vs Temperature                | 68     |
| $V_{OL}$       | Low-level output voltage                        | vs Common-mode input voltage  | 69     |
|                |   | vs Temperature                | 70, 72 |
|                |   | vs Differential input voltage | 71     |
|                |   | vs Low-level output current   | 73     |
| $A_{VD}$       | Large-signal differential voltage amplification | vs Supply voltage             | 74     |
|                |   | vs Temperature                | 75     |
|                |   | vs Frequency                  | 86, 87 |
| $I_{IB}$       | Input bias current                              | vs Temperature                | 76     |
| $I_{IO}$       | Input offset current                            | vs Temperature                | 76     |
| $V_{IC}$       | Common-mode input voltage                       | vs Supply voltage             | 77     |
| $I_{DD}$       | Supply current                                  | vs Supply voltage             | 78     |
|                |   | vs Temperature                | 79     |
| SR             | Slew rate                                       | vs Supply voltage             | 80     |
|                |   | vs Temperature                | 81     |
|                | Bias select current                             | vs Supply current             | 82     |
| $V_{O(PP)}$    | Maximum peak-to-peak output voltage             | vs Frequency                  | 83     |
| $B_1$          | Unity-gain bandwidth                            | vs Temperature                | 84     |
|                |   | vs Supply voltage             | 85     |
| $\phi_m$       | Phase margin                                    | vs Supply voltage             | 88     |
|                |   | vs Temperature                | 89     |
|                |   | vs Load capacitance           | 90     |
| $V_n$          | Equivalent input noise voltage                  | vs Frequency                  | 91     |
|                |   | Phase shift                   | 86, 87 |

TYPICAL CHARACTERISTICS (LOW-BIAS MODE)

DISTRIBUTION OF TLV2341  
 INPUT OFFSET VOLTAGE

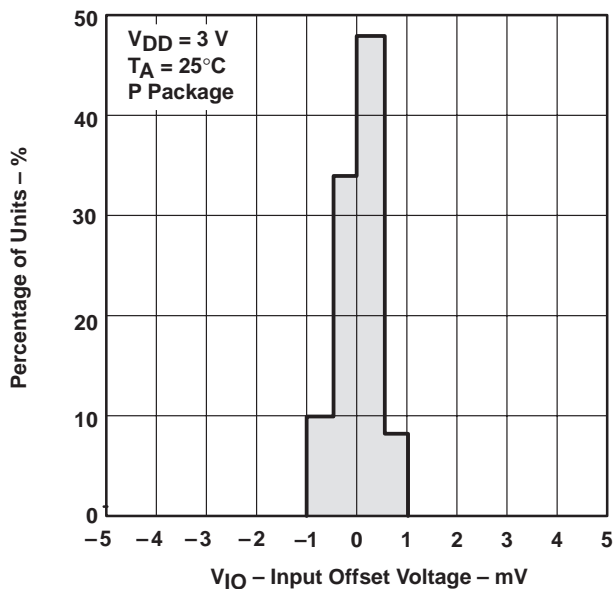

Figure 62

DISTRIBUTION OF TLV2341  
 INPUT OFFSET VOLTAGE

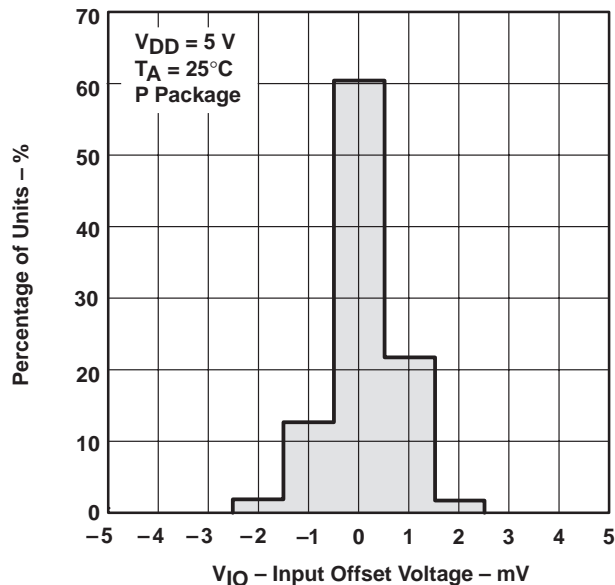

Figure 63

DISTRIBUTION OF TLV2341  
 INPUT OFFSET VOLTAGE  
 TEMPERATURE COEFFICIENT

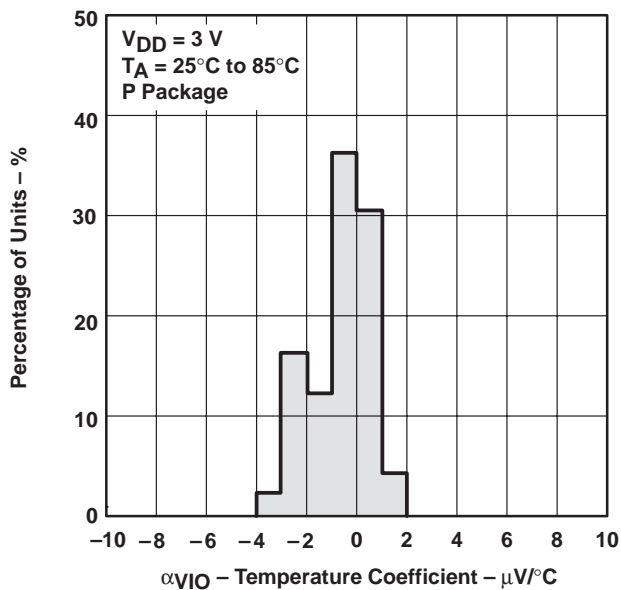

Figure 64

DISTRIBUTION OF TLV2341  
 INPUT OFFSET VOLTAGE  
 TEMPERATURE COEFFICIENT

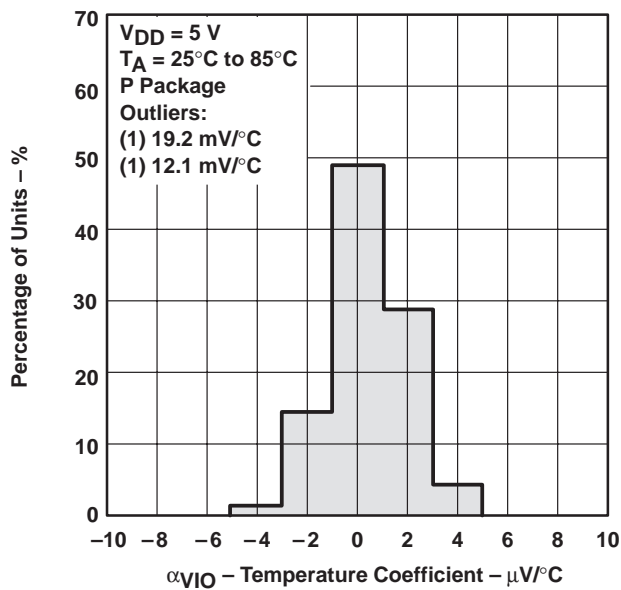

Figure 65

TYPICAL CHARACTERISTICS (LOW-BIAS MODE)

HIGH-LEVEL OUTPUT VOLTAGE  
 vs  
 HIGH-LEVEL OUTPUT CURRENT

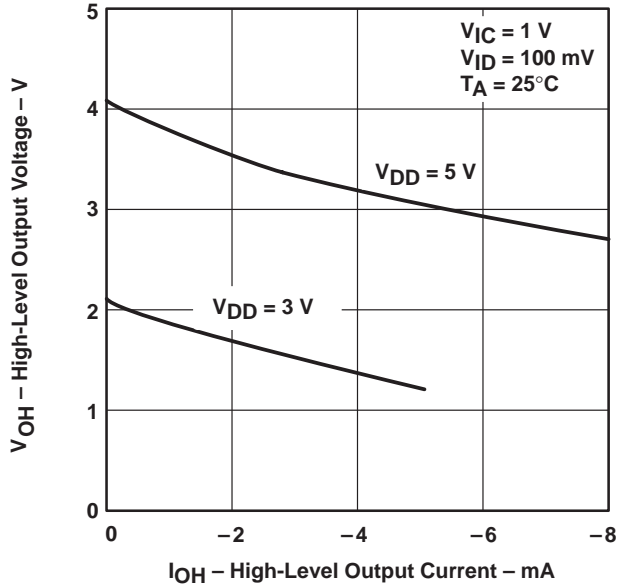

Figure 66

HIGH-LEVEL OUTPUT VOLTAGE  
 vs  
 SUPPLY VOLTAGE

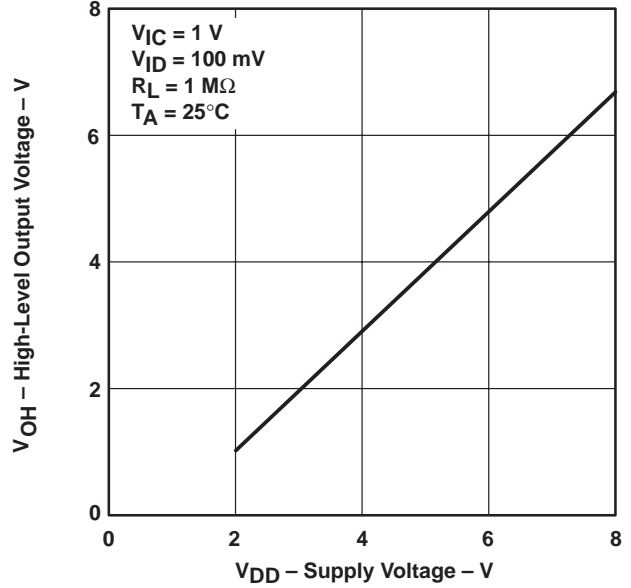

Figure 67

HIGH-LEVEL OUTPUT VOLTAGE  
 vs  
 FREE-AIR TEMPERATURE

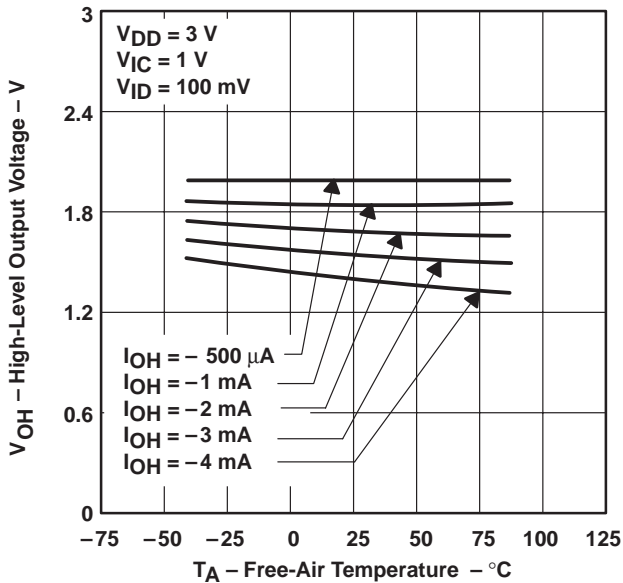

Figure 68

LOW-LEVEL OUTPUT VOLTAGE  
 vs  
 COMMON-MODE INPUT VOLTAGE

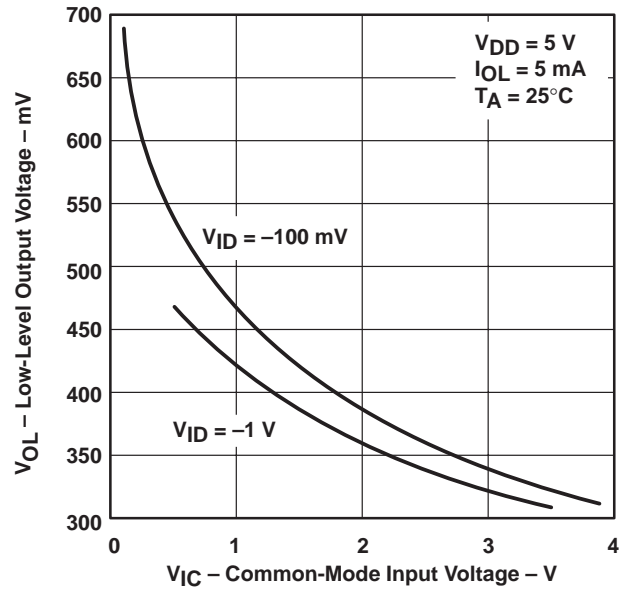
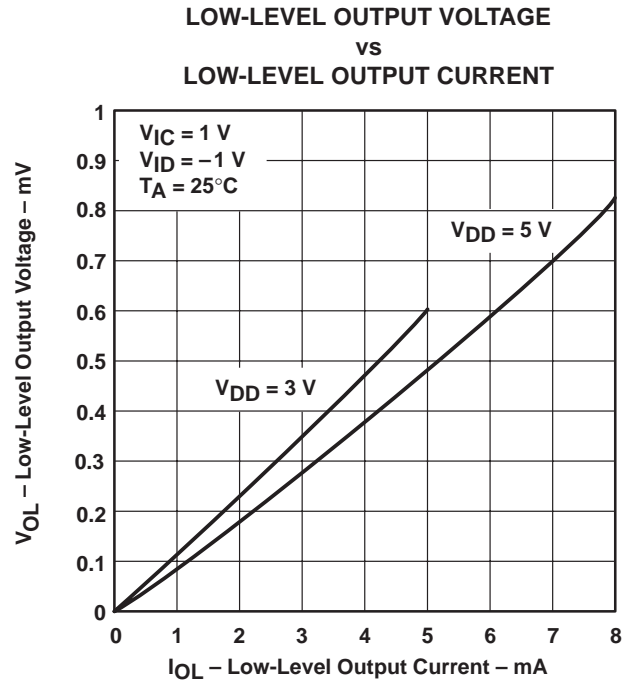
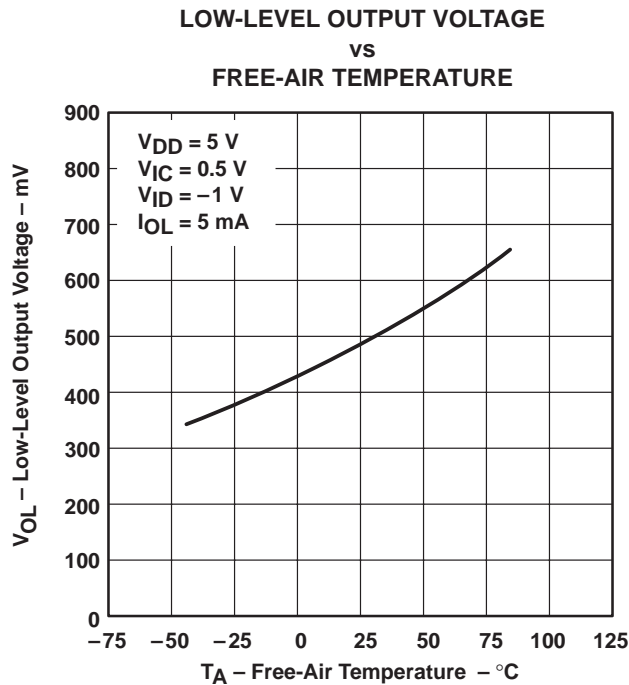
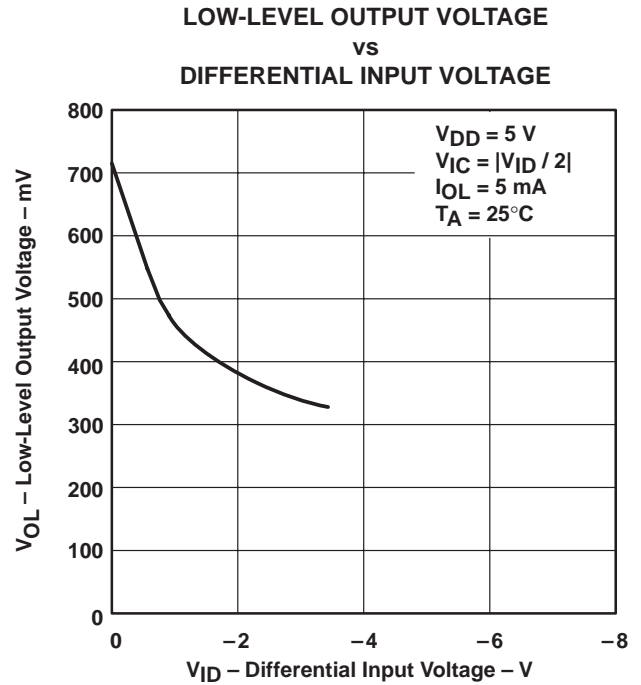
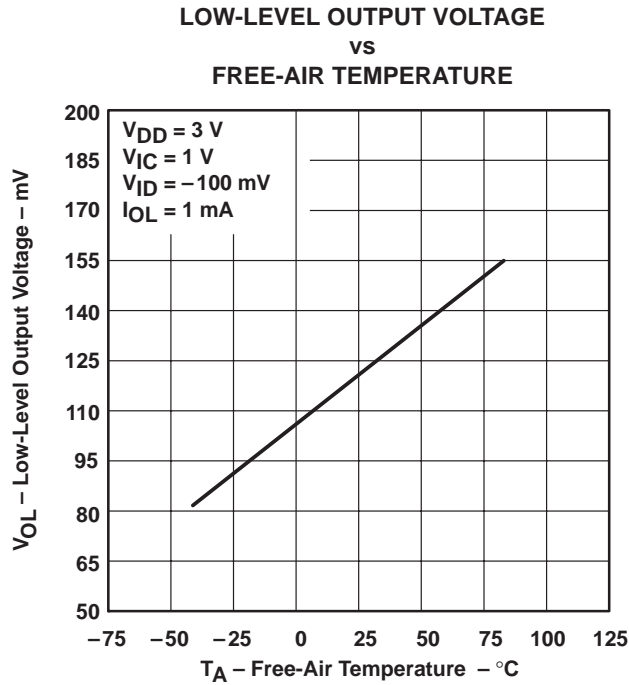

Figure 69

**TYPICAL CHARACTERISTICS (LOW-BIAS MODE)**



**TYPICAL CHARACTERISTICS (LOW-BIAS MODE)**

**LARGE-SIGNAL  
 DIFFERENTIAL VOLTAGE AMPLIFICATION  
 vs  
 SUPPLY VOLTAGE**

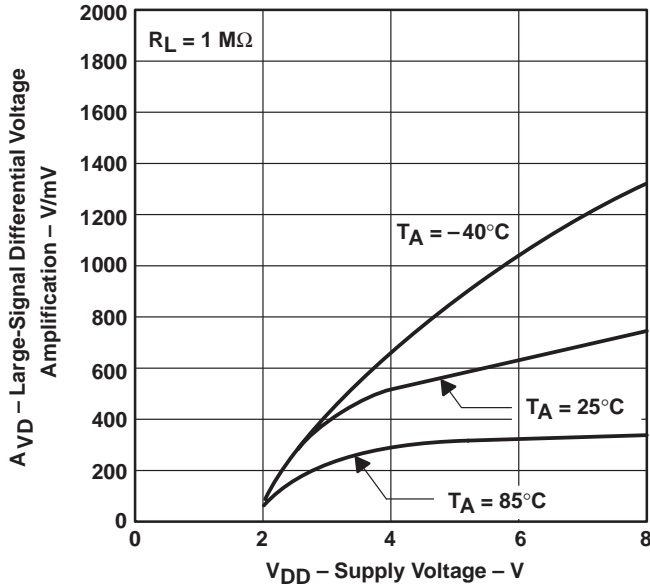

Figure 74

**LARGE-SIGNAL  
 DIFFERENTIAL VOLTAGE AMPLIFICATION  
 vs  
 FREE-AIR TEMPERATURE**

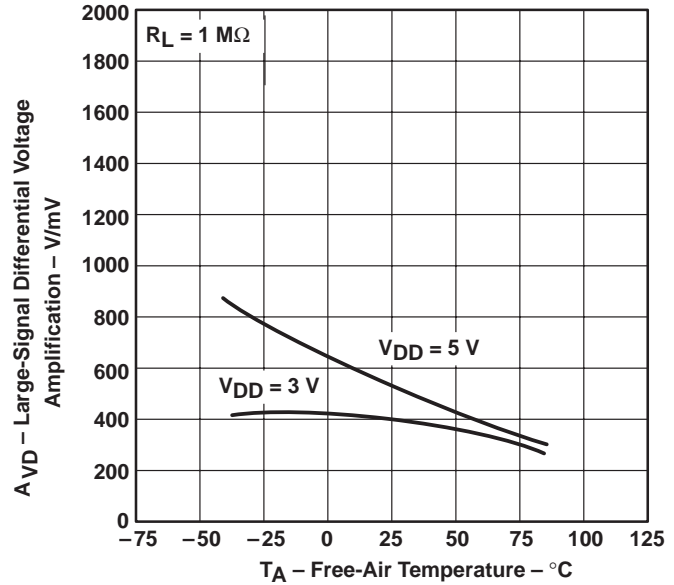

Figure 75

**INPUT BIAS CURRENT AND INPUT  
 OFFSET CURRENT  
 vs  
 FREE-AIR TEMPERATURE**

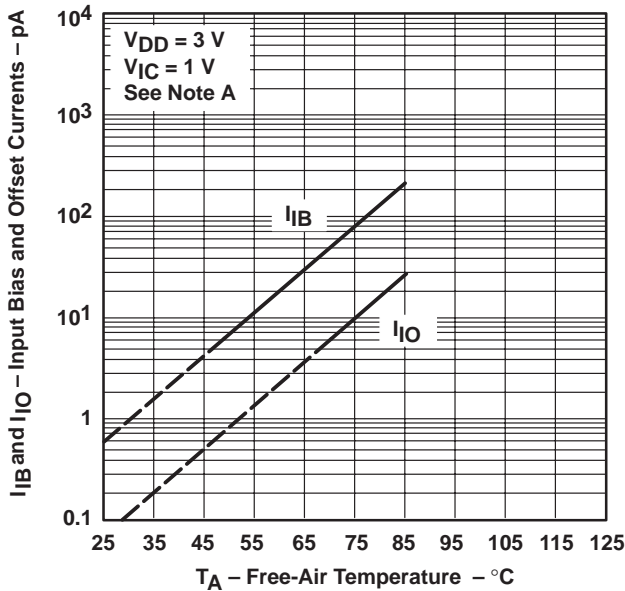

Figure 76

**COMMON-MODE INPUT VOLTAGE  
 POSITIVE LIMIT  
 vs  
 SUPPLY VOLTAGE**

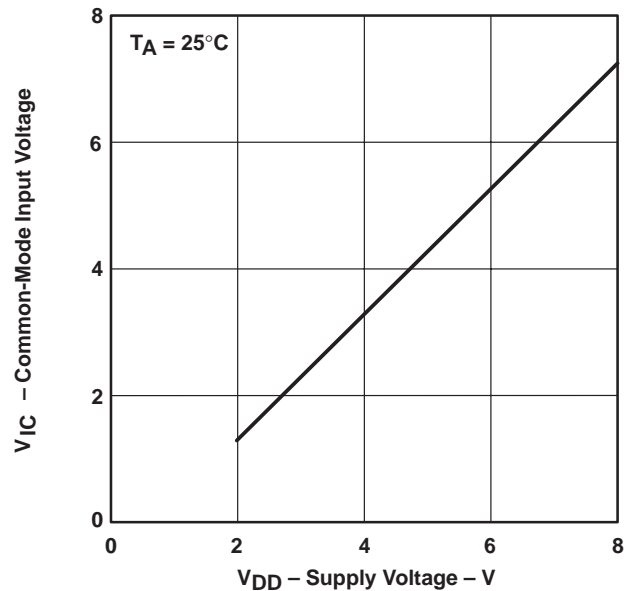

Figure 77

NOTE A: The typical values of input bias current and input offset current below 5 pA are determined mathematically.

TYPICAL CHARACTERISTICS (LOW-BIAS MODE)

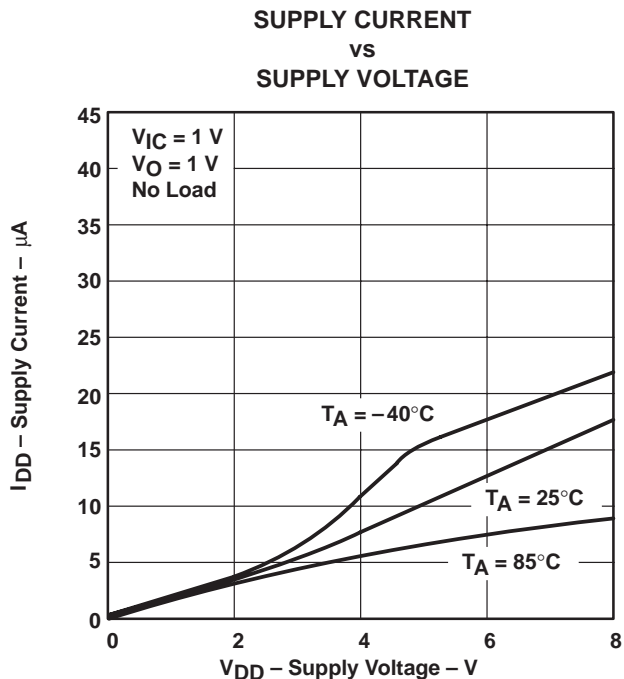

Figure 78

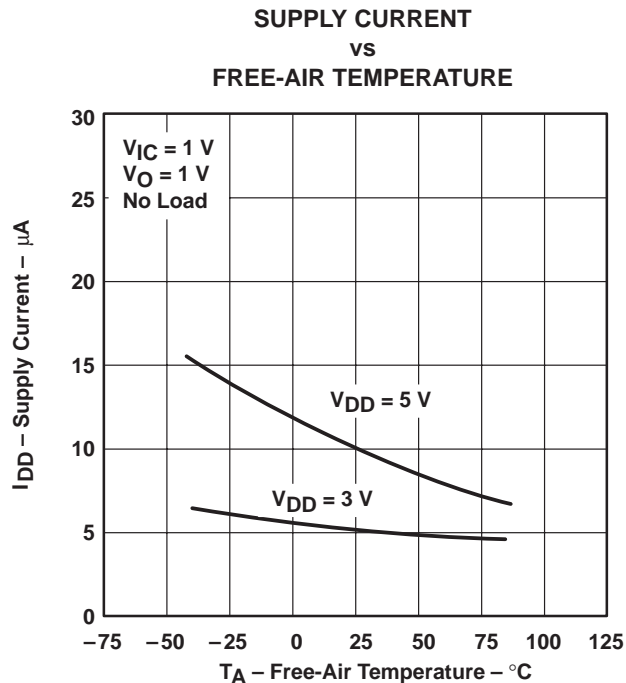

Figure 79

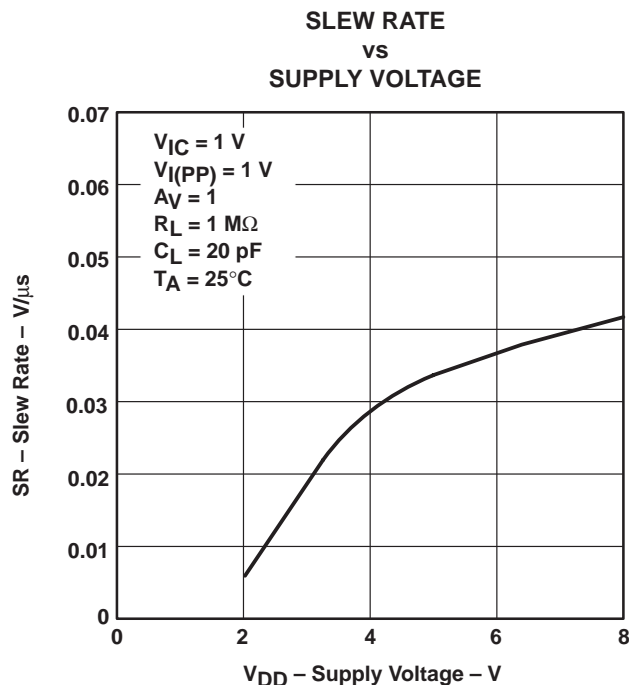

Figure 80

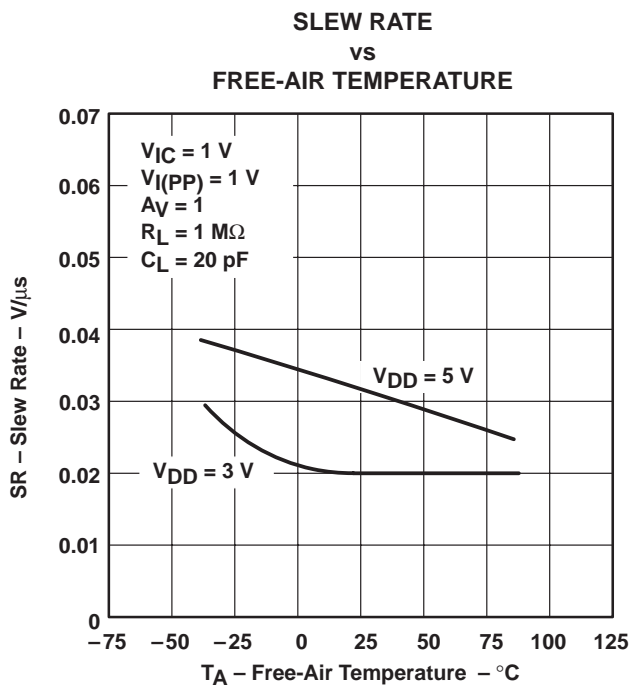

Figure 81

TYPICAL CHARACTERISTICS (LOW-BIAS MODE)

BIAS SELECT CURRENT  
 vs  
 SUPPLY VOLTAGE

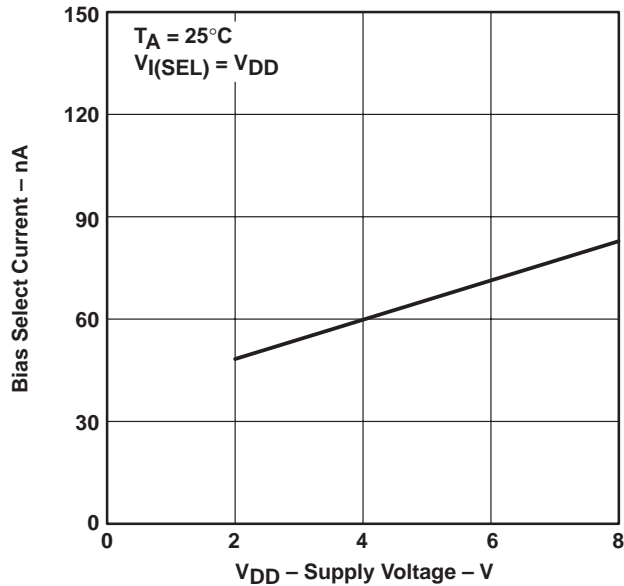

Figure 82

MAXIMUM PEAK-TO-PEAK OUTPUT VOLTAGE  
 vs  
 FREQUENCY

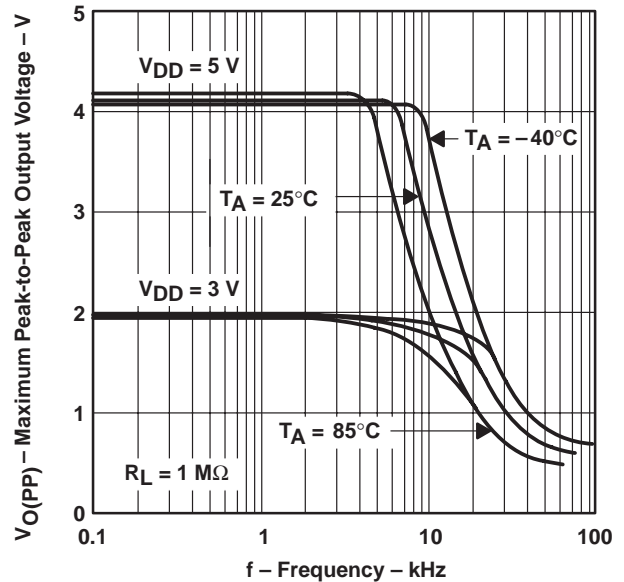

Figure 83

UNITY-GAIN BANDWIDTH  
 vs  
 FREE-AIR TEMPERATURE

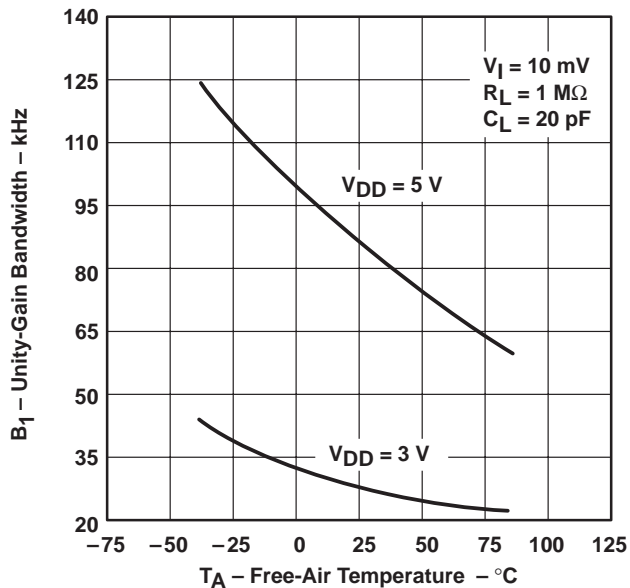

Figure 84

UNITY-GAIN BANDWIDTH  
 vs  
 SUPPLY VOLTAGE

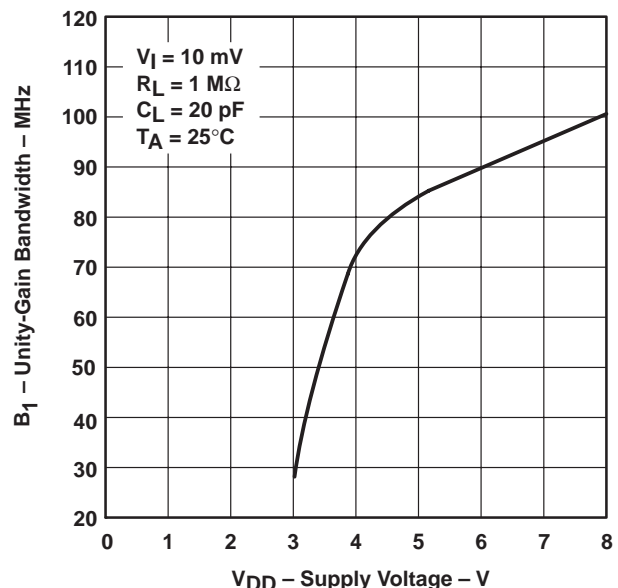

Figure 85



**TYPICAL CHARACTERISTICS (LOW-BIAS MODE)**

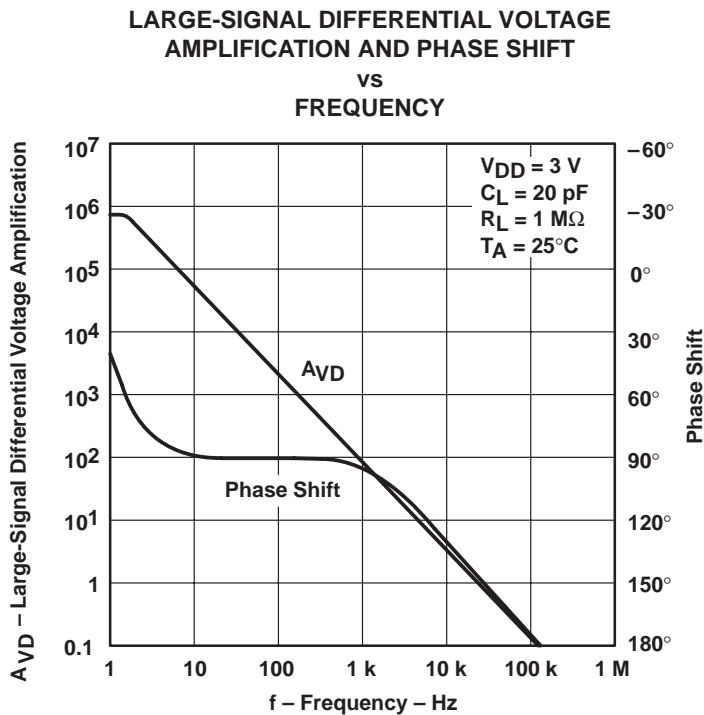

Figure 86

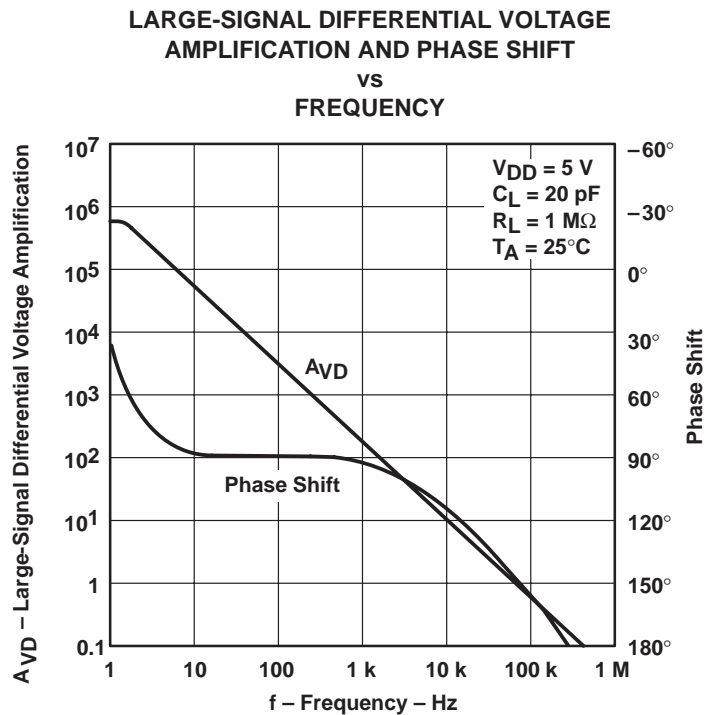
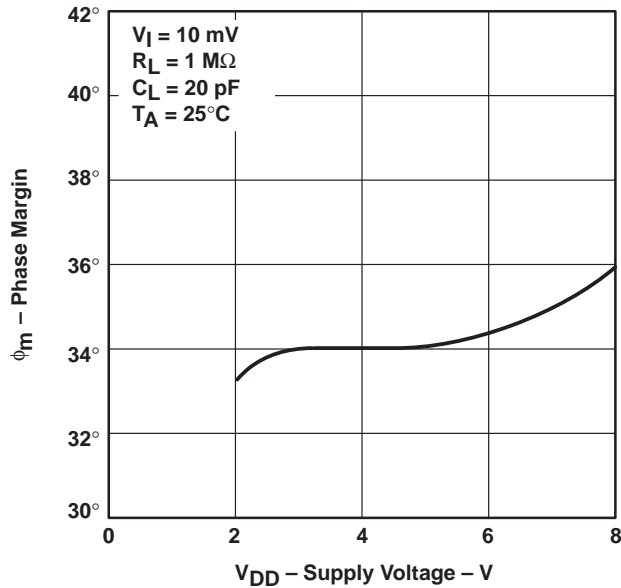

Figure 87

**TYPICAL CHARACTERISTICS (LOW-BIAS MODE)**

**PHASE MARGIN  
 vs  
 SUPPLY VOLTAGE**



**Figure 88**

**PHASE MARGIN  
 vs  
 FREE-AIR TEMPERATURE**

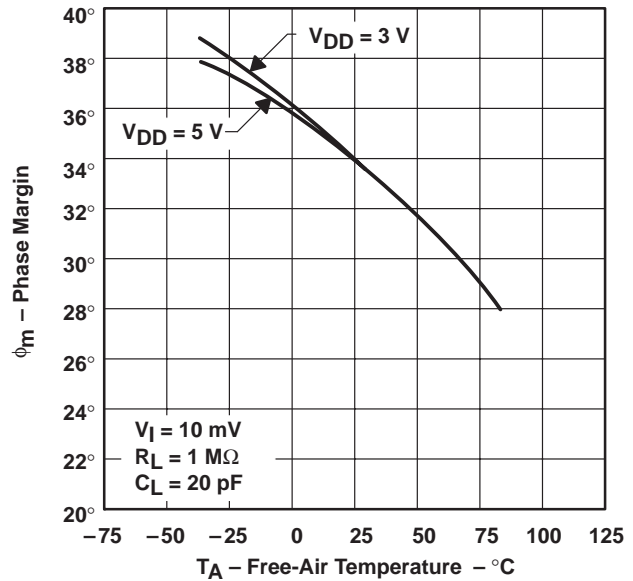

**Figure 89**

**PHASE MARGIN  
 vs  
 LOAD CAPACITANCE**

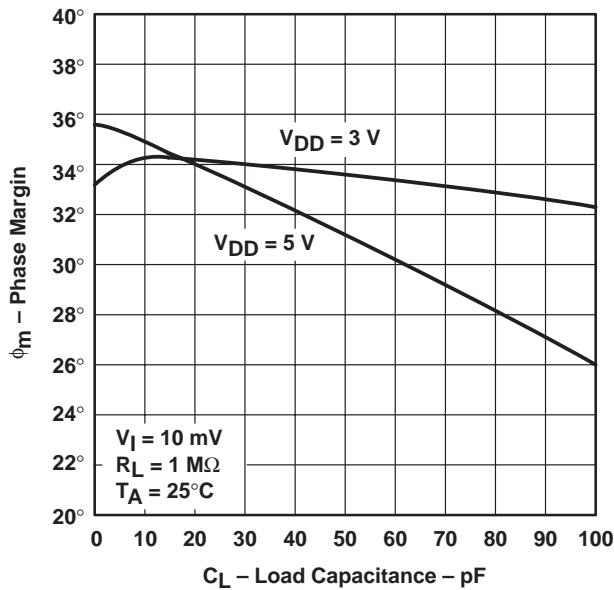

**Figure 90**

**EQUIVALENT INPUT NOISE VOLTAGE  
 vs  
 FREQUENCY**

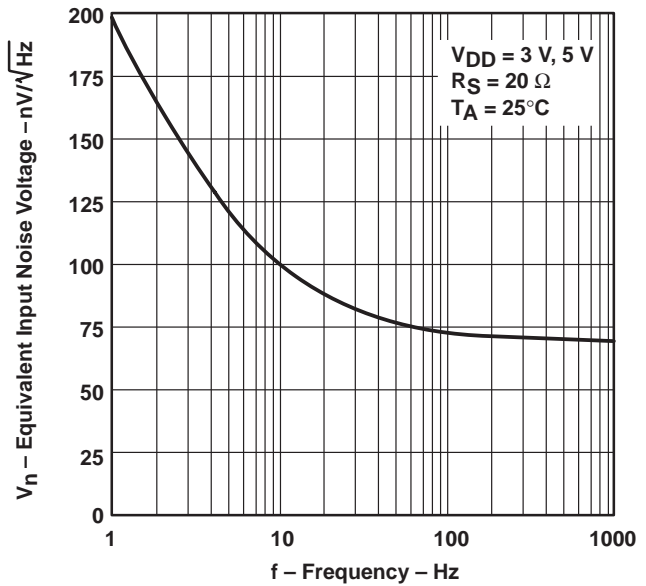
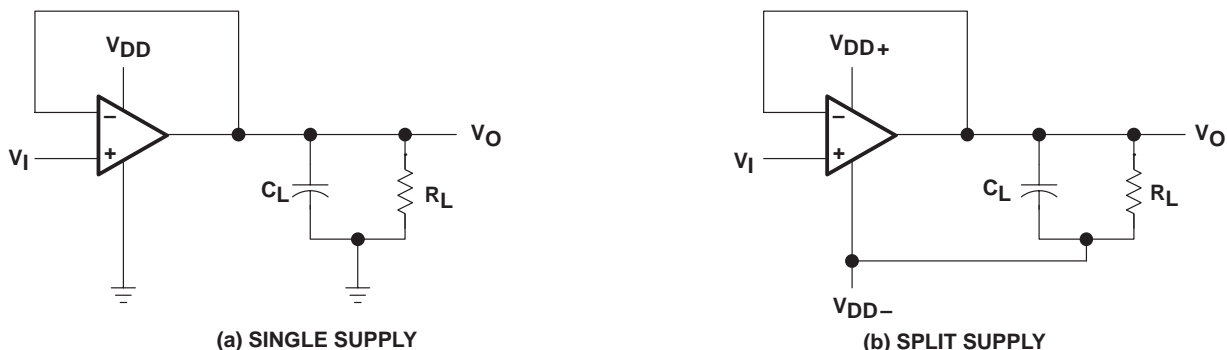

**Figure 91**

**PARAMETER MEASUREMENT INFORMATION**

**single-supply versus split-supply test circuits**

Because the TLV2341 is optimized for single-supply operation, circuit configurations used for the various tests often present some inconvenience since the input signal, in many cases, must be offset from ground. This inconvenience can be avoided by testing the device with split supplies and the output load tied to the negative rail. A comparison of single-supply versus split-supply test circuits is shown below. The use of either circuit gives the same result.



**Figure 92. Unity-Gain Amplifier**

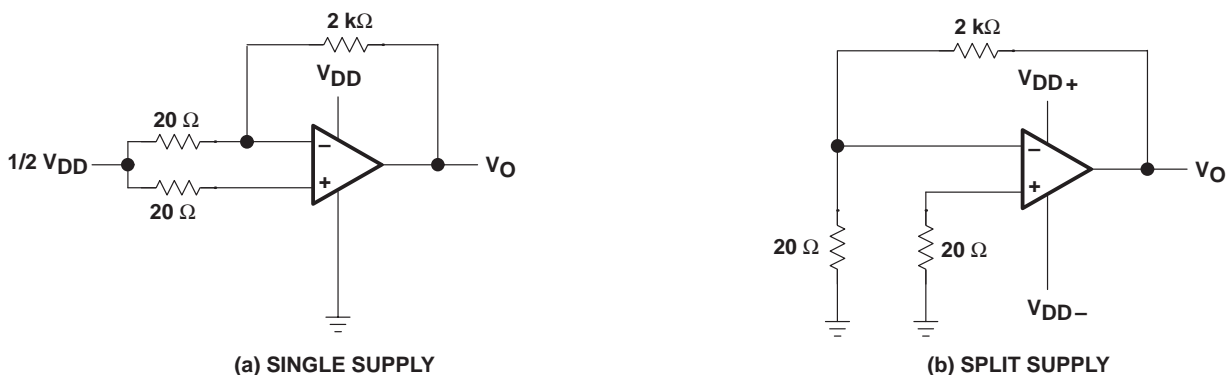

**Figure 93. Noise-Test Circuits**

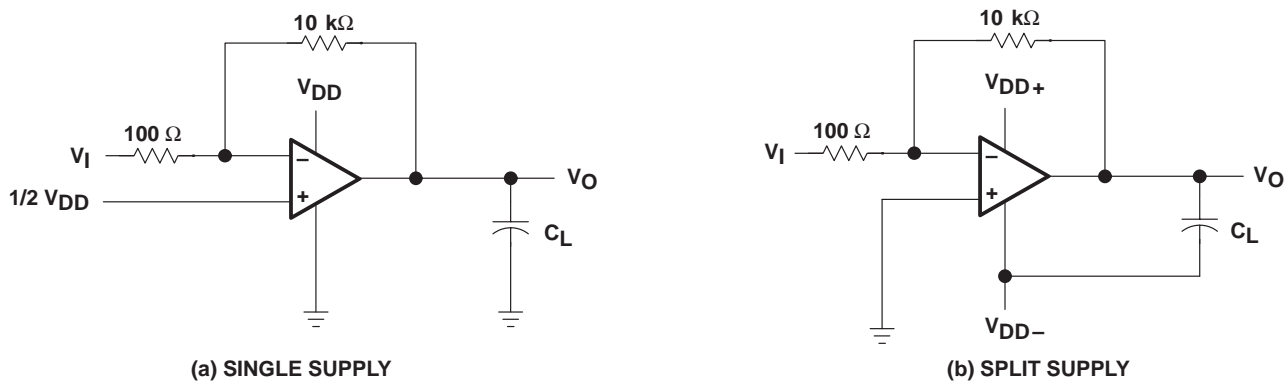

**Figure 94. Gain-of-100 Inverting Amplifier**

## PARAMETER MEASUREMENT INFORMATION

### input bias current

Because of the high input impedance of the TLV2341 operational amplifier, attempts to measure the input bias current can result in erroneous readings. The bias current at normal ambient temperature is typically less than 1 pA, a value that is easily exceeded by leakages on the test socket. Two suggestions are offered to avoid erroneous measurements:

- Isolate the device from other potential leakage sources. Use a grounded shield around and between the device inputs (see Figure 95). Leakages that would otherwise flow to the inputs are shunted away.
- Compensate for the leakage of the test socket by actually performing an input bias current test (using a picoammeter) with no device in the test socket. The actual input bias current can then be calculated by subtracting the open-socket leakage readings from the readings obtained with a device in the test socket.

Many automatic testers as well as some bench-top operational amplifier testers use the servo-loop technique with a resistor in series with the device input to measure the input bias current (the voltage drop across the series resistor is measured and the bias current is calculated). This method requires that a device be inserted into the test socket to obtain a correct reading; therefore, an open-socket reading is not feasible using this method.

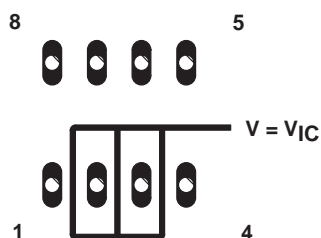

Figure 95. Isolation Metal Around Device Inputs (P package)

### low-level output voltage

To obtain low-level supply-voltage operation, some compromise is necessary in the input stage. This compromise results in the device low-level output voltage being dependent on both the common-mode input voltage level as well as the differential input voltage level. When attempting to correlate low-level output readings with those quoted in the electrical specifications, these two conditions should be observed. If conditions other than these are to be used, please refer to the Typical Characteristics section of this data sheet.

### input offset voltage temperature coefficient

Erroneous readings often result from attempts to measure temperature coefficient of input offset voltage. This parameter is actually a calculation using input offset voltage measurements obtained at two different temperatures. When one (or both) of the temperatures is below freezing, moisture can collect on both the device and the test socket. This moisture results in leakage and contact resistance which can cause erroneous input offset voltage readings. The isolation techniques previously mentioned have no effect on the leakage since the moisture also covers the isolation metal itself, thereby rendering it useless. These measurements should be performed at temperatures above freezing to minimize error.

### full-power response

Full-power response, the frequency above which the operational amplifier slew rate limits the output voltage swing, is often specified two ways: full-linear response and full-peak response. The full-linear response is

## PARAMETER MEASUREMENT INFORMATION

generally measured by monitoring the distortion level of the output while increasing the frequency of a sinusoidal input signal until the maximum frequency is found above which the output contains significant distortion. The full-peak response is defined as the maximum output frequency, without regard to distortion, above which full peak-to-peak output swing cannot be maintained.

Because there is no industry-wide accepted value for significant distortion, the full-peak response is specified in this data sheet and is measured using the circuit of Figure 92. The initial setup involves the use of a sinusoidal input to determine the maximum peak-to-peak output of the device (the amplitude of the sinusoidal wave is increased until clipping occurs). The sinusoidal wave is then replaced with a square wave of the same amplitude. The frequency is then increased until the maximum peak-to-peak output can no longer be maintained (Figure 96). A square wave is used to allow a more accurate determination of the point at which the maximum peak-to-peak output is reached.

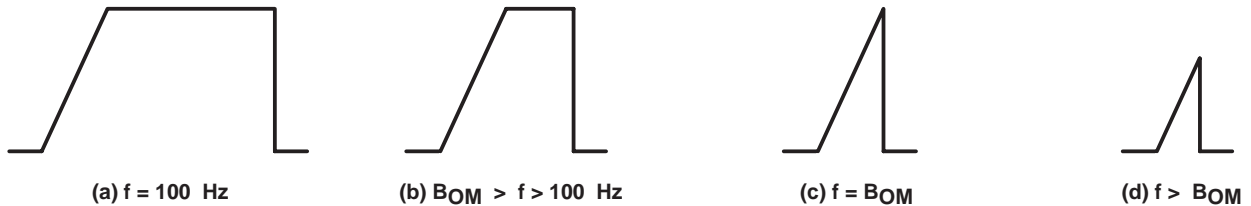

**Figure 96. Full-Power-Response Output Signal**

### test time

Inadequate test time is a frequent problem, especially when testing CMOS devices in a high-volume, short-test-time environment. Internal capacitances are inherently higher in CMOS than in bipolar and BiFET devices and require longer test times than their bipolar and BiFET counterparts. The problem becomes more pronounced with reduced supply levels and lower temperatures.

## APPLICATION INFORMATION

### single-supply operation

While the TLV2341 performs well using dual-power supplies (also called balanced or split supplies), the design is optimized for single-supply operation. This includes an input common-mode voltage range that encompasses ground as well as an output voltage range that pulls down to ground. The supply voltage range extends down to 2 V, thus allowing operation with supply levels commonly available for TTL and HCMOS.

Many single-supply applications require that a voltage be applied to one input to establish a reference level that is above ground. This virtual ground can be generated using two large resistors, but a preferred technique is to use a virtual-ground generator such as the TLE2426. The TLE2426 supplies an accurate voltage equal to  $V_{DD}/2$ , while consuming very little power and is suitable for supply voltages of greater than 4 V.

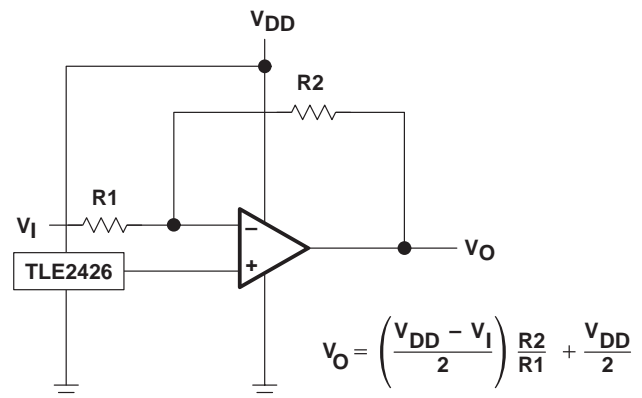

**Figure 97. Inverting Amplifier With Voltage Reference**

**APPLICATION INFORMATION**

**single-supply operation (continued)**

The TLV2341 works well in conjunction with digital logic; however, when powering both linear devices and digital logic from the same power supply, the following precautions are recommended:

- Power the linear devices from separate bypassed supply lines (see Figure 98); otherwise, the linear device supply rails can fluctuate due to voltage drops caused by high switching currents in the digital logic.
- Use proper bypass techniques to reduce the probability of noise-induced errors. Single capacitive decoupling is often adequate; however, RC decoupling may be necessary in high-frequency applications.

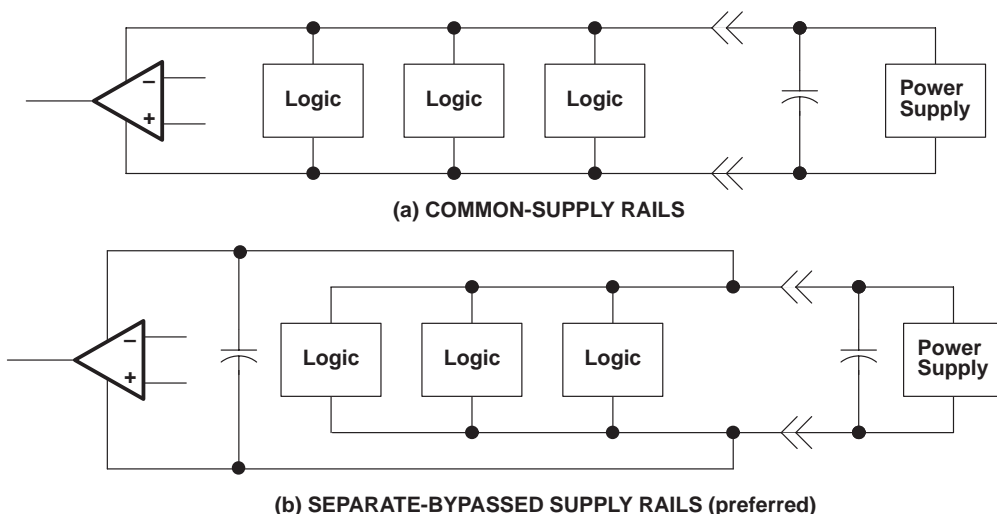

**Figure 98. Common Versus Separate Supply Rails**

**input offset voltage nulling**

The TLV2341 offers external input offset null control. Nulling of the input offset voltage can be achieved by adjusting a 25-kΩ potentiometer connected between the offset null terminals with the wiper connected as shown in Figure 99. The amount of nulling range varies with the bias selection. In the high-bias mode, the nulling range allows the maximum offset voltage specified to be trimmed to zero. In low-bias and medium-bias modes, total nulling may not be possible.

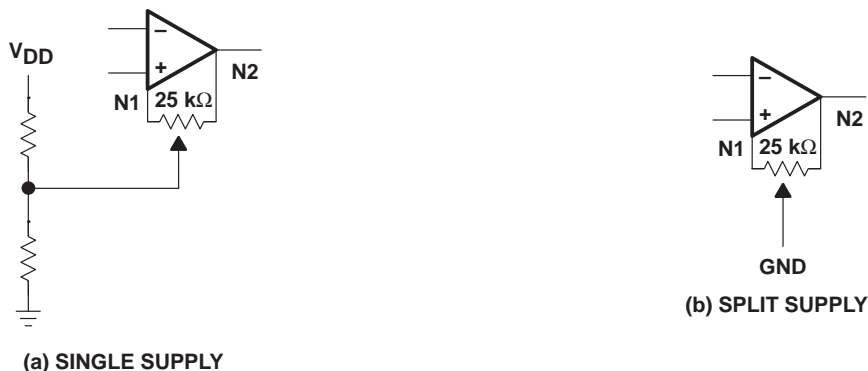
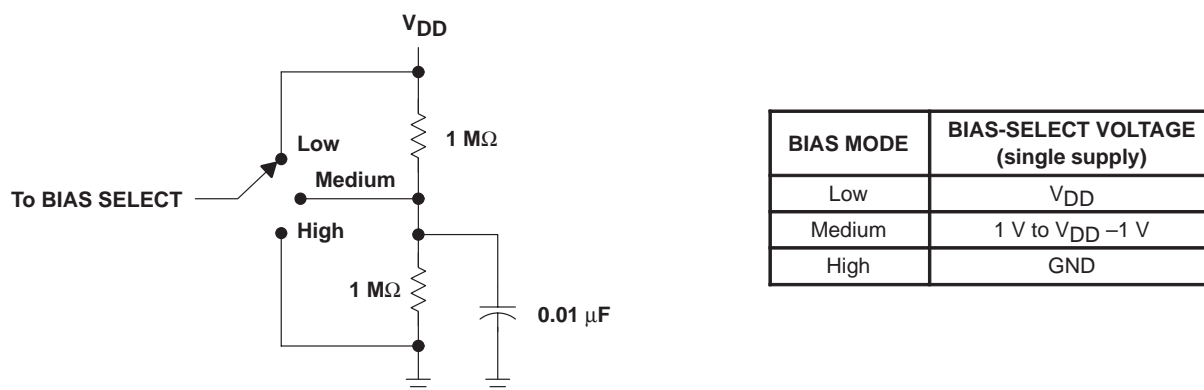

**Figure 99. Input Offset Voltage Null Circuit**

## APPLICATION INFORMATION

### bias selection

Bias selection is achieved by connecting the bias-select pin to one of the three voltage levels (see Figure 100). For medium-bias applications, it is recommended that the bias-select pin be connected to the midpoint between the supply rails. This is a simple procedure in split-supply applications, since this point is ground. In single-supply applications, the medium-bias mode necessitates using a voltage divider as indicated. The use of large-value resistors in the voltage divider reduces the current drain of the divider from the supply line. However, large-value resistors used in conjunction with a large-value capacitor require significant time to charge up to the supply midpoint after the supply is switched on. A voltage other than the midpoint may be used if it is within the voltages specified in the following table.



**Figure 100. Bias Selection for Single-Supply Applications**

### input characteristics

The TLV2341 is specified with a minimum and a maximum input voltage that, if exceeded at either input, could cause the device to malfunction. Exceeding this specified range is a common problem, especially in single-supply operation. The lower range limit includes the negative rail, while the upper range limit is specified at  $V_{DD} - 1$  V at  $T_A = 25^\circ\text{C}$  and at  $V_{DD} - 1.2$  V at all other temperatures.

The use of the polysilicon-gate process and the careful input circuit design gives the TLV2341 good input offset voltage drift characteristics relative to conventional metal-gate processes. Offset voltage drift in CMOS devices is highly influenced by threshold voltage shifts caused by polarization of the phosphorus dopant implanted in the oxide. Placing the phosphorus dopant in a conductor (such as a polysilicon gate) alleviates the polarization problem, thus reducing threshold voltage shifts by more than an order of magnitude. The offset voltage drift with time has been calculated to be typically 0.1  $\mu\text{V}/\text{month}$ , including the first month of operation.

Because of the extremely high input impedance and resulting low bias-current requirements, the TLV2341 is well suited for low-level signal processing; however, leakage currents on printed-circuit boards and sockets can easily exceed bias-current requirements and cause a degradation in device performance. It is good practice to include guard rings around inputs (similar to those of Figure 95 in the Parameter Measurement Information section). These guards should be driven from a low-impedance source at the same voltage level as the common-mode input (see Figure 101).

The inputs of any unused amplifiers should be tied to ground to avoid possible oscillation.

**APPLICATION INFORMATION**

**input characteristics (continued)**

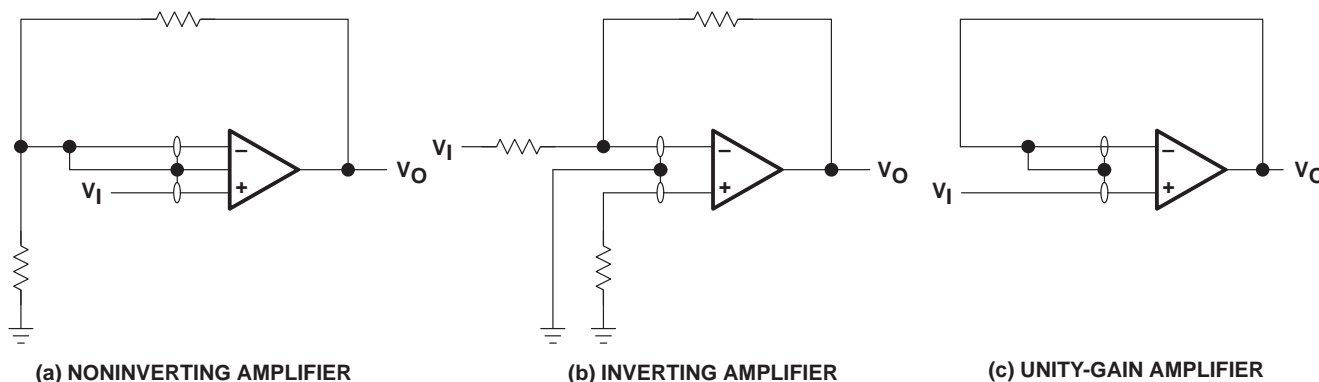

**Figure 101. Guard-Ring Schemes**

**noise performance**

The noise specifications in operational amplifiers circuits are greatly dependent on the current in the first-stage differential amplifier. The low input bias-current requirements of the TLV2341 results in a very low noise current, which is insignificant in most applications. This feature makes the device especially favorable over bipolar devices when using values of circuit impedance greater than 50 kΩ, since bipolar devices exhibit greater noise currents.

**feedback**

Operational amplifier circuits nearly always employ feedback, and since feedback is the first prerequisite for oscillation, caution is appropriate. Most oscillation problems result from driving capacitive loads and ignoring stray input capacitance. A small-value capacitor connected in parallel with the feedback resistor is an effective remedy (see Figure 102). The value of this capacitor is optimized empirically.

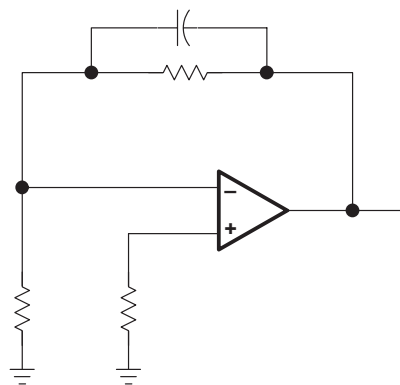

**Figure 102. Compensation for Input Capacitance**

**electrostatic-discharge protection**

The TLV2341 incorporates an internal electrostatic-discharge (ESD)-protection circuit that prevents functional failures at voltages up to 2000 V as tested under MIL-STD-883C, Method 3015.2. Care should be exercised, however, when handling these devices as exposure to ESD may result in the degradation of the device parametric performance. The protection circuit also causes the input bias currents to be temperature dependent and have the characteristics of a reverse-biased diode.

**latch-up**

Because CMOS devices are susceptible to latch-up due to their inherent parasitic thyristors, the TLV2341 inputs and output are designed to withstand –100-mA surge currents without sustaining latch-up; however, techniques should be used to reduce the chance of latch-up whenever possible. Internal protection diodes should not by



## APPLICATION INFORMATION

design be forward biased. Applied input and output voltage should not exceed the supply voltage by more than 300 mV. Care should be exercised when using capacitive coupling on pulse generators. Supply transients should be shunted by the use of decoupling capacitors (0.1 μF typical) located across the supply rails as close to the device as possible.

The current path established if latch-up occurs is usually between the positive supply rail and ground and can be triggered by surges on the supply lines and/or voltages on either the output or inputs that exceed the supply voltage. Once latch-up occurs, the current flow is limited only by the impedance of the power supply and the forward resistance of the parasitic thyristor and usually results in the destruction of the device. The chance of latch-up occurring increases with increasing temperature and supply voltages.

### output characteristics

The output stage of the TLV2341 is designed to sink and source relatively high amounts of current (see Typical Characteristics). If the output is subjected to a short-circuit condition, this high-current capability can cause device damage under certain conditions. Output current capability increases with supply voltage.

Although the TLV2341 possesses excellent high-level output voltage and current capability, methods are available for boosting this capability if needed. The simplest method involves the use of a pullup resistor ( $R_P$ ) connected from the output to the positive supply rail (see Figure 103). There are two disadvantages to the use of this circuit. First, the NMOS pulldown transistor N4 (see equivalent schematic) must sink a comparatively large amount of current. In this circuit, N4 behaves like a linear resistor with an on resistance between approximately 60 Ω and 180 Ω, depending on how hard the operational amplifier input is driven. With very low values of  $R_P$ , a voltage offset from 0 V at the output occurs. Secondly, pullup resistor  $R_P$  acts as a drain load to N4 and the gain of the operational amplifier is reduced at output voltage levels where N5 is not supplying the output current.

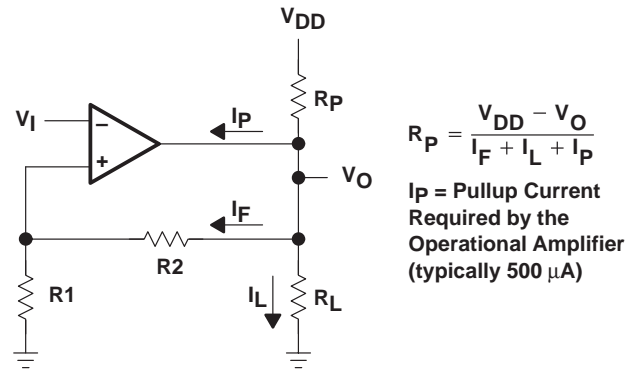

**Figure 103. Resistive Pullup to Increase  $V_{OH}$**

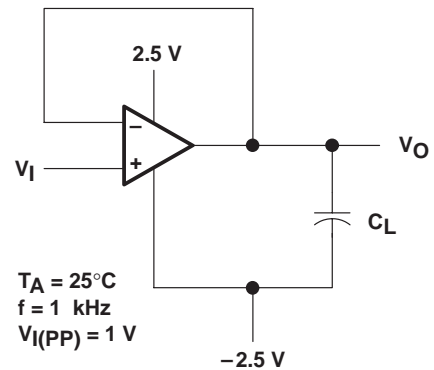
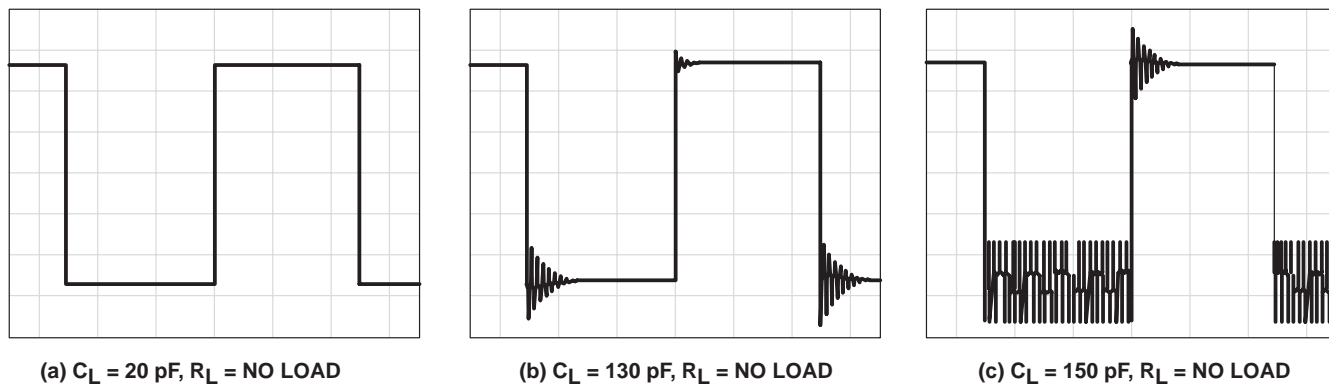

**Figure 104. Test Circuit for Output Characteristics**

All operating characteristics of the TLV2341 are measured using a 20-pF load. The device drives higher capacitive loads; however, as output load capacitance increases, the resulting response pole occurs at lower frequencies thereby causing ringing, peaking, or even oscillation (see Figures 105, 106 and 107). In many cases, adding some compensation in the form of a series resistor in the feedback loop alleviates the problem.

**APPLICATION INFORMATION**

**output characteristics (continued)**



**Figure 105. Effect of Capacitive Loads in High-Bias Mode**

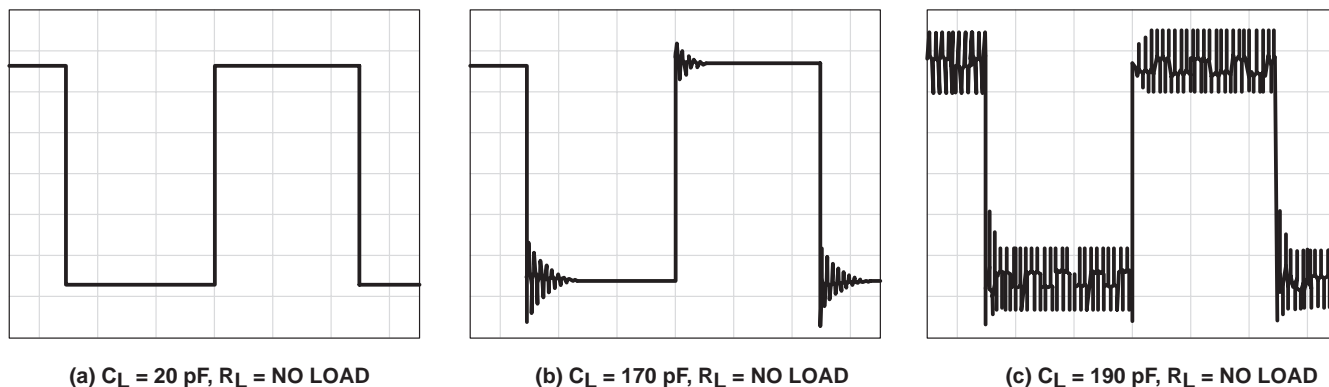

**Figure 106. Effect of Capacitive Loads in Medium-Bias Mode**

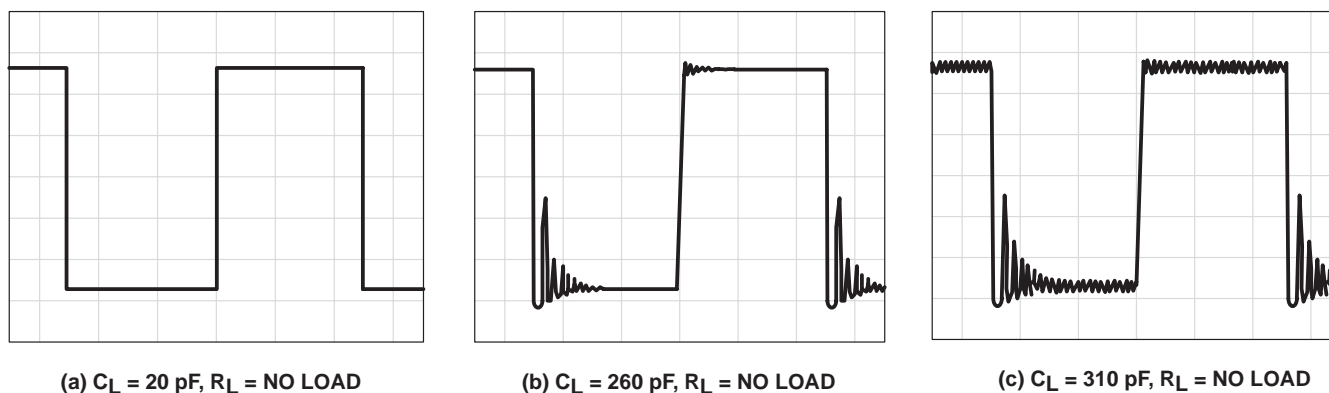

**Figure 107. Effect of Capacitive Loads in Low-Bias Mode**

**PACKAGING INFORMATION**

| Orderable Device | Status<br>(1) | Package Type | Package Drawing | Pins | Package Qty | Eco Plan<br>(2)         | Lead/Ball Finish<br>(6) | MSL Peak Temp<br>(3) | Op Temp (°C) | Device Marking<br>(4/5) | Samples                 |
|------------------|---------------|--------------|-----------------|------|-------------|-------------------------|-------------------------|----------------------|--------------|-------------------------|-------------------------|
| TLV2341ID        | ACTIVE        | SOIC         | D               | 8    | 75          | Green (RoHS & no Sb/Br) | CU NIPDAU               | Level-1-260C-UNLIM   |              | 2341I                   | <a href="#">Samples</a> |
| TLV2341IDG4      | ACTIVE        | SOIC         | D               | 8    | 75          | Green (RoHS & no Sb/Br) | CU NIPDAU               | Level-1-260C-UNLIM   |              | 2341I                   | <a href="#">Samples</a> |
| TLV2341IDR       | ACTIVE        | SOIC         | D               | 8    | 2500        | Green (RoHS & no Sb/Br) | CU NIPDAU               | Level-1-260C-UNLIM   |              | 2341I                   | <a href="#">Samples</a> |
| TLV2341IP        | OBSOLETE      | PDIP         | P               | 8    |             | TBD                     | Call TI                 | Call TI              |              | TLV2341IP               |                         |
| TLV2341IPE4      | ACTIVE        | PDIP         | P               | 8    |             | TBD                     | Call TI                 | Call TI              |              |                         | <a href="#">Samples</a> |
| TLV2341IPWLE     | OBSOLETE      | TSSOP        | PW              | 8    |             | TBD                     | Call TI                 | Call TI              |              |                         |                         |

(1) The marketing status values are defined as follows:

**ACTIVE:** Product device recommended for new designs.

**LIFEBUY:** TI has announced that the device will be discontinued, and a lifetime-buy period is in effect.

**NRND:** Not recommended for new designs. Device is in production to support existing customers, but TI does not recommend using this part in a new design.

**PREVIEW:** Device has been announced but is not in production. Samples may or may not be available.

**OBSOLETE:** TI has discontinued the production of the device.

(2) Eco Plan - The planned eco-friendly classification: Pb-Free (RoHS), Pb-Free (RoHS Exempt), or Green (RoHS & no Sb/Br) - please check <http://www.ti.com/productcontent> for the latest availability information and additional product content details.

**TBD:** The Pb-Free/Green conversion plan has not been defined.

**Pb-Free (RoHS):** TI's terms "Lead-Free" or "Pb-Free" mean semiconductor products that are compatible with the current RoHS requirements for all 6 substances, including the requirement that lead not exceed 0.1% by weight in homogeneous materials. Where designed to be soldered at high temperatures, TI Pb-Free products are suitable for use in specified lead-free processes.

**Pb-Free (RoHS Exempt):** This component has a RoHS exemption for either 1) lead-based flip-chip solder bumps used between the die and package, or 2) lead-based die adhesive used between the die and leadframe. The component is otherwise considered Pb-Free (RoHS compatible) as defined above.

**Green (RoHS & no Sb/Br):** TI defines "Green" to mean Pb-Free (RoHS compatible), and free of Bromine (Br) and Antimony (Sb) based flame retardants (Br or Sb do not exceed 0.1% by weight in homogeneous material)

(3) MSL, Peak Temp. - The Moisture Sensitivity Level rating according to the JEDEC industry standard classifications, and peak solder temperature.

(4) There may be additional marking, which relates to the logo, the lot trace code information, or the environmental category on the device.

(5) Multiple Device Markings will be inside parentheses. Only one Device Marking contained in parentheses and separated by a "~" will appear on a device. If a line is indented then it is a continuation of the previous line and the two combined represent the entire Device Marking for that device.

<sup>(6)</sup> Lead/Ball Finish - Orderable Devices may have multiple material finish options. Finish options are separated by a vertical ruled line. Lead/Ball Finish values may wrap to two lines if the finish value exceeds the maximum column width.

**Important Information and Disclaimer:**The information provided on this page represents TI's knowledge and belief as of the date that it is provided. TI bases its knowledge and belief on information provided by third parties, and makes no representation or warranty as to the accuracy of such information. Efforts are underway to better integrate information from third parties. TI has taken and continues to take reasonable steps to provide representative and accurate information but may not have conducted destructive testing or chemical analysis on incoming materials and chemicals. TI and TI suppliers consider certain information to be proprietary, and thus CAS numbers and other limited information may not be available for release.

In no event shall TI's liability arising out of such information exceed the total purchase price of the TI part(s) at issue in this document sold by TI to Customer on an annual basis.

**TAPE AND REEL INFORMATION**

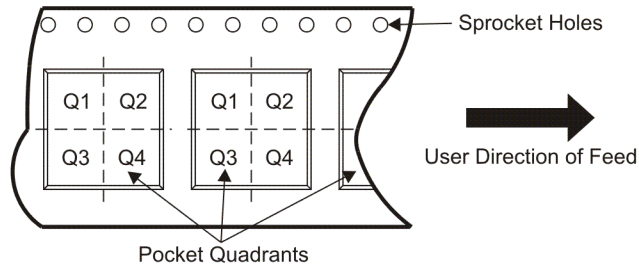
**QUADRANT ASSIGNMENTS FOR PIN 1 ORIENTATION IN TAPE**

\*All dimensions are nominal

| Device     | Package Type | Package Drawing | Pins | SPQ  | Reel Diameter (mm) | Reel Width W1 (mm) | A0 (mm) | B0 (mm) | K0 (mm) | P1 (mm) | W (mm) | Pin1 Quadrant |
|------------|--------------|-----------------|------|------|--------------------|--------------------|---------|---------|---------|---------|--------|---------------|
| TLV2341IDR | SOIC         | D               | 8    | 2500 | 330.0              | 12.4               | 6.4     | 5.2     | 2.1     | 8.0     | 12.0   | Q1            |

**TAPE AND REEL BOX DIMENSIONS**



\*All dimensions are nominal

| Device     | Package Type | Package Drawing | Pins | SPQ  | Length (mm) | Width (mm) | Height (mm) |
|------------|--------------|-----------------|------|------|-------------|------------|-------------|
| TLV2341IDR | SOIC         | D               | 8    | 2500 | 340.5       | 338.1      | 20.6        |

## IMPORTANT NOTICE

Texas Instruments Incorporated and its subsidiaries (TI) reserve the right to make corrections, enhancements, improvements and other changes to its semiconductor products and services per JESD46, latest issue, and to discontinue any product or service per JESD48, latest issue. Buyers should obtain the latest relevant information before placing orders and should verify that such information is current and complete. All semiconductor products (also referred to herein as "components") are sold subject to TI's terms and conditions of sale supplied at the time of order acknowledgment.

TI warrants performance of its components to the specifications applicable at the time of sale, in accordance with the warranty in TI's terms and conditions of sale of semiconductor products. Testing and other quality control techniques are used to the extent TI deems necessary to support this warranty. Except where mandated by applicable law, testing of all parameters of each component is not necessarily performed.

TI assumes no liability for applications assistance or the design of Buyers' products. Buyers are responsible for their products and applications using TI components. To minimize the risks associated with Buyers' products and applications, Buyers should provide adequate design and operating safeguards.

TI does not warrant or represent that any license, either express or implied, is granted under any patent right, copyright, mask work right, or other intellectual property right relating to any combination, machine, or process in which TI components or services are used. Information published by TI regarding third-party products or services does not constitute a license to use such products or services or a warranty or endorsement thereof. Use of such information may require a license from a third party under the patents or other intellectual property of the third party, or a license from TI under the patents or other intellectual property of TI.

Reproduction of significant portions of TI information in TI data books or data sheets is permissible only if reproduction is without alteration and is accompanied by all associated warranties, conditions, limitations, and notices. TI is not responsible or liable for such altered documentation. Information of third parties may be subject to additional restrictions.

Resale of TI components or services with statements different from or beyond the parameters stated by TI for that component or service voids all express and any implied warranties for the associated TI component or service and is an unfair and deceptive business practice. TI is not responsible or liable for any such statements.

Buyer acknowledges and agrees that it is solely responsible for compliance with all legal, regulatory and safety-related requirements concerning its products, and any use of TI components in its applications, notwithstanding any applications-related information or support that may be provided by TI. Buyer represents and agrees that it has all the necessary expertise to create and implement safeguards which anticipate dangerous consequences of failures, monitor failures and their consequences, lessen the likelihood of failures that might cause harm and take appropriate remedial actions. Buyer will fully indemnify TI and its representatives against any damages arising out of the use of any TI components in safety-critical applications.

In some cases, TI components may be promoted specifically to facilitate safety-related applications. With such components, TI's goal is to help enable customers to design and create their own end-product solutions that meet applicable functional safety standards and requirements. Nonetheless, such components are subject to these terms.

No TI components are authorized for use in FDA Class III (or similar life-critical medical equipment) unless authorized officers of the parties have executed a special agreement specifically governing such use.

Only those TI components which TI has specifically designated as military grade or "enhanced plastic" are designed and intended for use in military/aerospace applications or environments. Buyer acknowledges and agrees that any military or aerospace use of TI components which have **not** been so designated is solely at the Buyer's risk, and that Buyer is solely responsible for compliance with all legal and regulatory requirements in connection with such use.

TI has specifically designated certain components as meeting ISO/TS16949 requirements, mainly for automotive use. In any case of use of non-designated products, TI will not be responsible for any failure to meet ISO/TS16949.

### Products

|                              |  |
|------------------------------|--|
| Audio                        | <a href="http://www.ti.com/audio">www.ti.com/audio</a>                               |
| Amplifiers                   | <a href="http://amplifier.ti.com">amplifier.ti.com</a>                               |
| Data Converters              | <a href="http://dataconverter.ti.com">dataconverter.ti.com</a>                       |
| DLP® Products                | <a href="http://www.dlp.com">www.dlp.com</a>   |
| DSP                          | <a href="http://dsp.ti.com">dsp.ti.com</a>   |
| Clocks and Timers            | <a href="http://www.ti.com/clocks">www.ti.com/clocks</a>                             |
| Interface                    | <a href="http://interface.ti.com">interface.ti.com</a>                               |
| Logic                        | <a href="http://logic.ti.com">logic.ti.com</a>                                       |
| Power Mgmt                   | <a href="http://power.ti.com">power.ti.com</a>                                       |
| Microcontrollers             | <a href="http://microcontroller.ti.com">microcontroller.ti.com</a>                   |
| RFID                         | <a href="http://www.ti-rfid.com">www.ti-rfid.com</a>                                 |
| OMAP Applications Processors | <a href="http://www.ti.com/omap">www.ti.com/omap</a>                                 |
| Wireless Connectivity        | <a href="http://www.ti.com/wirelessconnectivity">www.ti.com/wirelessconnectivity</a> |

### Applications

|                               |  |
|-------------------------------|--|
| Automotive and Transportation | <a href="http://www.ti.com/automotive">www.ti.com/automotive</a>                         |
| Communications and Telecom    | <a href="http://www.ti.com/communications">www.ti.com/communications</a>                 |
| Computers and Peripherals     | <a href="http://www.ti.com/computers">www.ti.com/computers</a>                           |
| Consumer Electronics          | <a href="http://www.ti.com/consumer-apps">www.ti.com/consumer-apps</a>                   |
| Energy and Lighting           | <a href="http://www.ti.com/energy">www.ti.com/energy</a>                                 |
| Industrial                    | <a href="http://www.ti.com/industrial">www.ti.com/industrial</a>                         |
| Medical                       | <a href="http://www.ti.com/medical">www.ti.com/medical</a>                               |
| Security                      | <a href="http://www.ti.com/security">www.ti.com/security</a>                             |
| Space, Avionics and Defense   | <a href="http://www.ti.com/space-avionics-defense">www.ti.com/space-avionics-defense</a> |
| Video and Imaging             | <a href="http://www.ti.com/video">www.ti.com/video</a>                                   |

### TI E2E Community

[e2e.ti.com](http://e2e.ti.com)