

CD54/74AC240/241/244 CD54/74ACT240/241/244

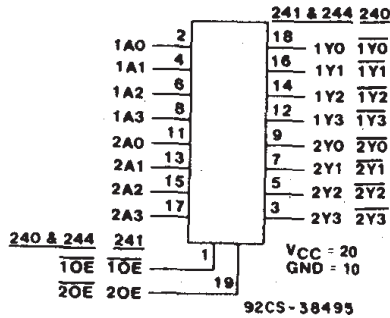

Data sheet acquired from Harris Semiconductor
SCHS287B - Revised January 2004



FUNCTIONAL DIAGRAM & TERMINAL ASSIGNMENT

The RCA CD54/74AC240, CD54/74AC241, and CD54/74AC244 and the CD54/74ACT240, CD54/74ACT241, and CD54/74ACT244 3-state octal buffer/line drivers use the RCA ADVANCED CMOS technology. The CD54/74AC/ACT240 and CD54/74AC/ACT244 have active-LOW output enables ($\overline{1OE}$, $\overline{2OE}$). The CD54/74AC/ACT241 has one active-LOW ($\overline{1OE}$) and one active-HIGH (2OE) output enable.

The CD74AC240 and CD74ACT240 are supplied in 20-lead dual-in-line plastic packages (E suffix) and 20-lead small-outline packages (M and M96 suffixes). The CD74AC241 is supplied in 20-lead dual-in-line plastic packages (E suffix) and the CD74ACT241 is supplied in 20-lead dual-in-line plastic packages (E suffix) and 20-lead small-outline packages (M96 suffix). The CD74AC244 and CD74ACT244 are supplied in 20-lead dual-in-line plastic packages (E suffix), 20-lead small-outline packages (M and M96 suffixes), and 20-lead shrink small-outline packages (SM96 suffix). These package types are operable over the following temperature ranges: Commercial (0 to 70°C); Industrial (-40 to +85°C); and Extended Industrial/Military (-55 to +125°C).

The CD54AC240 and CD54AC244 and the CD54ACT240, CD54ACT241, and CD54ACT244 are supplied in 20-lead hermetic dual-in-line ceramic packages (F3A suffix) and are operable over the -55 to +125°C temperature range.

Octal Buffer/Line Drivers, 3-State

- CD54/74AC/ACT240 - Inverting
- CD54/74AC/ACT241 - Non-Inverting
- CD54/74AC/ACT244 - Non-Inverting

Type Features:

- Buffered inputs
- Typical propagation delay:
3.6 ns @ $V_{CC} = 5V$, $T_A = 25^\circ C$, $C_L = 50 pF$

Family Features:

- Exceeds 2-kV ESD Protection - MIL-STD-883, Method 3015
- SCR-Latch-up-resistant CMOS process and circuit design
- Speed of bipolar FAST*/AS/S with significantly reduced power consumption
- Balanced propagation delays
- AC types feature 1.5-V to 5.5-V operation and balanced noise immunity at 30% of the supply
- ± 24 -mA output drive current
 - Fanout to 15 FAST* ICs
 - Drives 50-ohm transmission lines

*FAST is a Registered Trademark of Fairchild Semiconductor Corp.

TRUTH TABLES

| INPUTS | | OUTPUT | |
|-------------------------------------|---|--------|--|
| $\overline{1OE}$, $\overline{2OE}$ | A | Y | |
| L | L | H | |
| L | H | L | |
| H | X | Z | |

(AC/ACT240)

| INPUTS | | OUTPUT | |
|-------------------------------------|---|--------|--|
| $\overline{1OE}$, $\overline{2OE}$ | A | Y | |
| L | L | L | |
| L | H | H | |
| H | X | Z | |

(AC/ACT244)

| INPUTS | | OUTPUT | | INPUTS | | OUTPUT | |
|------------------|----|--------|-----|--------|----|--------|--|
| $\overline{1OE}$ | 1A | 1Y | 2OE | 2A | 2Y | | |
| L | L | L | L | X | Z | | |
| L | H | H | H | L | L | | |
| H | X | Z | H | H | H | | |

(AC/ACT241)

H = HIGH Voltage Level
L = LOW Voltage Level
X = Immaterial
Z = HIGH Impedance

This data sheet is applicable to the CD54/74AC240, CD54ACT240, and CD54/74ACT241. The CD54/74AC241 were not acquired from Harris Semiconductor. See SCHS244 for information on the CD74ACT240, CD74AC244, and CD74ACT244.

Copyright © 2004, Texas Instruments Incorporated

CD54/74AC240/241/244 CD54/74ACT240/241/244

MAXIMUM RATINGS, Absolute-Maximum Values:

| | |
|---|---|
| DC SUPPLY-VOLTAGE (V_{CC}) | -0.5 to 6 V |
| DC INPUT DIODE CURRENT, I_{IK} (for $V_I < -0.5$ V or $V_I > V_{CC} + 0.5$ V) | ± 20 mA |
| DC OUTPUT DIODE CURRENT, I_{OK} (for $V_O < -0.5$ V or $V_O > V_{CC} + 0.5$ V) | ± 50 mA |
| DC OUTPUT SOURCE OR SINK CURRENT per Output Pin, I_O (for $V_O > -0.5$ V or $V_O < V_{CC} + 0.5$ V) | ± 50 mA |
| DC V_{CC} or GROUND CURRENT (I_{CC} or I_{GND}) | ± 100 mA* |
| POWER DISSIPATION PER PACKAGE (P_D): | |
| For $T_A = -40$ to $+85^\circ\text{C}$ (Package Type E) | 500 mW |
| For $T_A = -40$ to $+70^\circ\text{C}$ (Package Type M) | 400 mW |
| For $T_A = +70$ to $+85^\circ\text{C}$ (Package Type M) | Derate Linearly at 6 mW/ $^\circ\text{C}$ to 310 mW |
| OPERATING-TEMPERATURE RANGE (T_A): CD54 | -55 to $+125^\circ\text{C}$ |
| CD74 | -40 to $+85^\circ\text{C}$ |
| STORAGE TEMPERATURE (T_{Stg}) | -65 to $+150^\circ\text{C}$ |
| LEAD TEMPERATURE (DURING SOLDERING): | |
| At distance $1/16 \pm 1/32$ in. (1.59 ± 0.79 mm) from case for 10 s maximum. | $+265^\circ\text{C}$ |
| Unit inserted into PC board min. thickness $1/16$ in. (1.59 mm) with solder contacting lead tips only. | $+300^\circ\text{C}$ |

* For up to 4 outputs per device: add ± 25 mA for each additional output.

RECOMMENDED OPERATING CONDITIONS:

For maximum reliability, normal operating conditions should be selected so that operation is always within the following ranges:

| CHARACTERISTIC | LIMITS | | UNITS |
|---|--------|----------|------------------|
| | MIN. | MAX. | |
| Supply-Voltage Range, V_{CC} *: (For $T_A =$ Full Package-Temperature Range) | | | |
| AC Types | 1.5 | 5.5 | V |
| ACT Types | 4.5 | 5.5 | V |
| DC Input or Output Voltage, V_I, V_O | 0 | V_{CC} | V |
| Operating Temperature, T_A | | | |
| CD54 | -55 | $+125$ | $^\circ\text{C}$ |
| CD74 | -40 | $+85$ | |
| Input Rise and Fall Slew Rate, dt/dv | | | |
| at 1.5 V to 3 V (AC Types) | 0 | 50 | ns/V |
| at 3.6 V to 5.5 V (AC Types) | 0 | 20 | ns/V |
| at 4.5 V to 5.5 V (ACT Types) | 0 | 10 | ns/V |

* Unless otherwise specified, all voltages are referenced to ground.

9

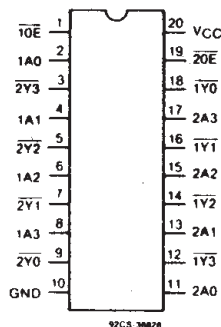

**CD54/74AC, ACT240 TYPES
TERMINAL ASSIGNMENT**

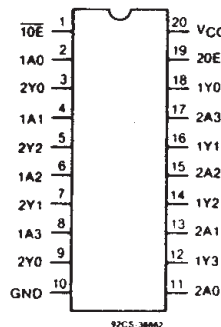

**CD54/74AC, ACT241 TYPES
TERMINAL ASSIGNMENT**

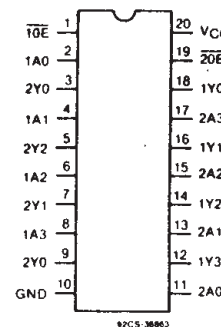

**CD54/74AC, ACT244 TYPES
TERMINAL ASSIGNMENT**

CD54/74AC240/241/244

CD54/74ACT240/241/244

STATIC ELECTRICAL CHARACTERISTICS: AC Series

| CHARACTERISTICS | TEST CONDITIONS | | V _{CC} (V) | AMBIENT TEMPERATURE (T _A) - °C | | | | | | UNITS |
|--|--|--|------------------------|--|------|------------|------|-------------|------|-------|
| | | | | +25 | | -40 to +85 | | -55 to +125 | | |
| | | | | MIN. | MAX. | MIN. | MAX. | MIN. | MAX. | |
| High-Level Input Voltage V _{IH} | | | 1.5 | 1.2 | — | 1.2 | — | 1.2 | — | V |
| | | | 3 | 2.1 | — | 2.1 | — | 2.1 | — | |
| | | | 5.5 | 3.85 | — | 3.85 | — | 3.85 | — | |
| Low-Level Input Voltage V _{IL} | | | 1.5 | — | 0.3 | — | 0.3 | — | 0.3 | V |
| | | | 3 | — | 0.9 | — | 0.9 | — | 0.9 | |
| | | | 5.5 | — | 1.65 | — | 1.65 | — | 1.65 | |
| High-Level Output Voltage V _{OH} | V _{IH} or V _{IL} | -0.05 | 1.5 | 1.4 | — | 1.4 | — | 1.4 | — | V |
| | | -0.05 | 3 | 2.9 | — | 2.9 | — | 2.9 | — | |
| | | -0.05 | 4.5 | 4.4 | — | 4.4 | — | 4.4 | — | |
| | | -4 | 3 | 2.58 | — | 2.48 | — | 2.4 | — | |
| | | -24 | 4.5 | 3.94 | — | 3.8 | — | 3.7 | — | |
| | | #, * | -75 | 5.5 | — | — | 3.85 | — | — | |
| Low-Level Output Voltage V _{OL} | V _{IH} or V _{IL} | 0.05 | 1.5 | — | 0.1 | — | 0.1 | — | 0.1 | V |
| | | 0.05 | 3 | — | 0.1 | — | 0.1 | — | 0.1 | |
| | | 0.05 | 4.5 | — | 0.1 | — | 0.1 | — | 0.1 | |
| | | 12 | 3 | — | 0.36 | — | 0.44 | — | 0.5 | |
| | | 24 | 4.5 | — | 0.36 | — | 0.44 | — | 0.5 | |
| | | #, * | 75 | 5.5 | — | — | — | 1.65 | — | |
| Input Leakage Current I _I | V _{CC} or GND | | 5.5 | — | ±0.1 | — | ±1 | — | ±1 | μA |
| | | | | | | | | | | |
| 3-State Leakage Current I _{OZ} | V _{IH} or V _{IL} | V _O = V _{CC} or GND | 5.5 | — | ±0.5 | — | ±5 | — | ±10 | μA |
| | | | | | | | | | | |
| Quiescent Supply Current, MSI I _{CC} | V _{CC} or GND | 0 | 5.5 | — | 8 | — | 80 | — | 160 | μA |

#Test one output at a time for a 1-second maximum duration. Measurement is made by forcing current and measuring voltage to minimize power dissipation.

*Test verifies a minimum 50-ohm transmission-line-drive capability at +85°C, 75 ohms at +125°C.

CD54/74AC240/241/244

CD54/74ACT240/241/244

STATIC ELECTRICAL CHARACTERISTICS: ACT Series

| CHARACTERISTICS | TEST CONDITIONS | | V _{CC} (V) | AMBIENT TEMPERATURE (T _A) - °C | | | | | | UNITS | |
|---|-----------------------|--|------------------------|--|------|------------|------|-------------|------|-------|----|
| | | | | +25 | | -40 to +85 | | -55 to +125 | | | |
| | V _I (V) | I _O (mA) | | MIN. | MAX. | MIN. | MAX. | MIN. | MAX. | | |
| High-Level Input Voltage | V _{IH} | | 4.5 to 5.5 | 2 | — | 2 | — | 2 | — | V | |
| Low-Level Input Voltage | V _{IL} | | 4.5 to 5.5 | — | 0.8 | — | 0.8 | — | 0.8 | V | |
| High-Level Output Voltage | V _{OIH} | $\left. \begin{array}{l} V_{IH} \text{ or } V_{IL} \\ \# , * \end{array} \right\}$ | -0.05 | 4.5 | 4.4 | — | 4.4 | — | 4.4 | — | V |
| | | | -24 | 4.5 | 3.94 | — | 3.8 | — | 3.7 | — | |
| | | | -75 | 5.5 | — | — | 3.85 | — | — | — | |
| | | | -50 | 5.5 | — | — | — | — | 3.85 | — | |
| Low-Level Output Voltage | V _{OOL} | $\left. \begin{array}{l} V_{IH} \text{ or } V_{IL} \\ \# , * \end{array} \right\}$ | 0.05 | 4.5 | — | 0.1 | — | 0.1 | — | 0.1 | V |
| | | | 24 | 4.5 | — | 0.36 | — | 0.44 | — | 0.5 | |
| | | | 75 | 5.5 | — | — | — | 1.65 | — | — | |
| | | | 50 | 5.5 | — | — | — | — | — | 1.65 | |
| Input Leakage Current | I _I | V _{CC} or GND | 5.5 | — | ±0.1 | — | ±1 | — | ±1 | μA | |
| 3-State Leakage Current | I _{OZ} | V _{IH} or V _{IL} V _O = V _{CC} or GND | 5.5 | — | ±0.5 | — | ±5 | — | ±10 | μA | |
| Quiescent Supply Current, MSI | I _{CC} | V _{CC} or GND | 0 | 5.5 | — | 8 | — | 80 | — | 160 | μA |
| Additional Quiescent Supply Current per Input Pin TTL Inputs High 1 Unit Load | ΔI _{CC} | V _{CC} -2.1 | 4.5 to 5.5 | — | 2.4 | — | 2.8 | — | 3 | mA | |

9

#Test one output at a time for a 1-second maximum duration. Measurement is made by forcing current and measuring voltage to minimize power dissipation.

*Test verifies a minimum 50-ohm transmission-line-drive capability at +85°C, 75 ohms at +125°C.

ACT INPUT LOADING TABLES

| CD54/74ACT240 | |
|---------------|-------------|
| INPUT | UNIT LOADS* |
| nA0 - A3 | 1.42 |
| 10E | 0.83 |
| 20E | 0.83 |

| CD54/74ACT241 | |
|---------------|-------------|
| INPUT | UNIT LOADS* |
| nA0 - A3 | 0.5 |
| 10E | 0.83 |
| 20E | 1.67 |

| CD54/74ACT244 | |
|---------------|-------------|
| INPUT | UNIT LOADS* |
| nA0 - A3 | 0.5 |
| 10E | 0.83 |
| 20E | 0.83 |

*Unit load is ΔI_{CC} limit specified in Static Characteristics Chart, e.g., 2.4 mA max. @ 25°C.

CD54/74AC240/241/244

CD54/74ACT240/241/244

SWITCHING CHARACTERISTICS: AC Series; $t_r, t_f = 3 \text{ ns}$, $C_L = 50 \text{ pF}$

| CHARACTERISTICS | SYMBOL | V_{CC} (V) | AMBIENT TEMPERATURE (T_A) - °C | | | | UNITS |
|--|----------------------------|-----------------|------------------------------------|------|-------------|------|-------|
| | | | -40 to +85 | | -55 to +125 | | |
| | | | MIN. | MAX. | MIN. | MAX. | |
| Propagation Delays: Data to Outputs AC240 | t_{PLH} | 1.5 | — | 82 | — | 90 | ns |
| | t_{PHL} | 3.3* | 2.6 | 9.2 | 2.5 | 10.1 | |
| AC241, 244 | t_{PLH} | 1.5 | — | 93 | — | 103 | ns |
| | t_{PHL} | 3.3 | 3 | 10.5 | 2.9 | 11.5 | |
| Output Enable Times | t_{PZL} | 1.5 | — | 136 | — | 150 | ns |
| | t_{PZH} | 3.3 | 4.6 | 16.4 | 4.5 | 18 | |
| Output Disable Times | t_{PLZ} | 1.5 | — | 136 | — | 150 | ns |
| | t_{PHZ} | 3.3 | 3.9 | 13.6 | 3.8 | 15 | |
| Power Dissipation Capacitance AC240 AC241, 244 | $C_{PD}\ddagger$ | — | 65 Typ. | | 65 Typ. | | pF |
| | | — | 71 Typ. | | 71 Typ. | | |
| Min. (Valley) V_{OH} During Switching of Other Outputs (Output Under Test Not Switching) | V_{OHV} See Fig. 1 | 5 | 4 Typ. @ 25°C | | | | V |
| Max. (Peak) V_{OL} During Switching of Other Outputs (Output Under Test Not Switching) | V_{OLP} See Fig. 1 | 5 | 1 Typ. @ 25°C | | | | V |
| Input Capacitance | C_i | — | — | 10 | — | 10 | pF |
| 3-State Output Capacitance | C_o | — | — | 15 | — | 15 | pF |

SWITCHING CHARACTERISTICS: ACT Series; $t_r, t_f = 3 \text{ ns}$, $C_L = 50 \text{ pF}$

| CHARACTERISTICS | SYMBOL | V_{CC} (V) | AMBIENT TEMPERATURE (T_A) - °C | | | | UNITS |
|--|----------------------------|-----------------|------------------------------------|------|-------------|------|-------|
| | | | -40 to +85 | | -55 to +125 | | |
| | | | MIN. | MAX. | MIN. | MAX. | |
| Propagation Delays: Data to Outputs ACT240 | t_{PLH} | 5† | 2.3 | 7.8 | 2.2 | 8.6 | ns |
| | t_{PHL} | 5 | 2.5 | 8.7 | 2.4 | 9.6 | |
| ACT241, 244 | t_{PLH} | 5 | 2.5 | 8.7 | 2.4 | 9.6 | ns |
| | t_{PHL} | 5 | 2.5 | 8.7 | 2.4 | 9.6 | |
| Output Enable Times | t_{PZL} | 5 | 3.5 | 12.2 | 3.4 | 13.4 | ns |
| | t_{PZH} | 5 | 3.5 | 12.2 | 3.4 | 13.4 | |
| Output Disable Times | t_{PLZ} | 5 | 3.5 | 12.2 | 3.4 | 13.4 | ns |
| | t_{PHZ} | 5 | 3.5 | 12.2 | 3.4 | 13.4 | |
| Power Dissipation Capacitance ACT240 ACT241, 244 | $C_{PD}\ddagger$ | — | 65 Typ. | | 65 Typ. | | pF |
| | | — | 71 Typ. | | 71 Typ. | | |
| Min. (Valley) V_{OH} During Switching of Other Outputs (Output Under Test Not Switching) | V_{OHV} See Fig. 1 | 5 | 4 Typ. @ 25°C | | | | V |
| Max. (Peak) V_{OL} During Switching of Other Outputs (Output Under Test Not Switching) | V_{OLP} See Fig. 1 | 5 | 1 Typ. @ 25°C | | | | V |
| Input Capacitance | C_i | — | — | 10 | — | 10 | pF |
| 3-State Output Capacitance | C_o | — | — | 15 | — | 15 | pF |

*3.3 V: min. is @ 3.6 V
max. is @ 3 V

†5 V: min. is @ 5.5 V
max. is @ 4.5 V

‡ C_{PD} is used to determine the dynamic power consumption, per package.

For AC series: $P_D = V_{CC}^2 f_i (C_{PD} + C_L)$

For ACT series: $P_D = V_{CC}^2 f_i (C_{PD} + C_L) + V_{CC} \Delta I_{CC}$ where f_i = input frequency

C_L = output load capacitance

V_{CC} = supply voltage.

Technical Data

CD54/74AC240/241/244 CD54/74ACT240/241/244

PARAMETER MEASUREMENT INFORMATION

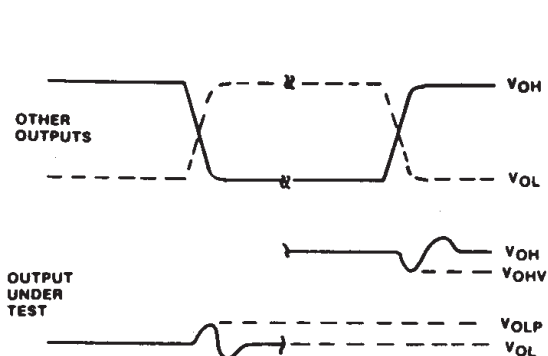

NOTES:

1. V_{OVH} and V_{OVL} are measured with respect to a ground reference near the output under test.
2. INPUT PULSES HAVE THE FOLLOWING CHARACTERISTICS:
 $PRR \leq 1$ MHz, $t_r = 3$ ns, $t_f = 3$ ns, SKEW 1 ns.
3. R.F. FIXTURE WITH 700-MHz DESIGN RULES REQUIRED. IC SHOULD BE SOLDERED INTO TEST BOARD AND BYPASSED WITH $0.1 \mu\text{F}$ CAPACITOR. SCOPE AND PROBES REQUIRE 700-MHz BANDWIDTH.

92CS-42406

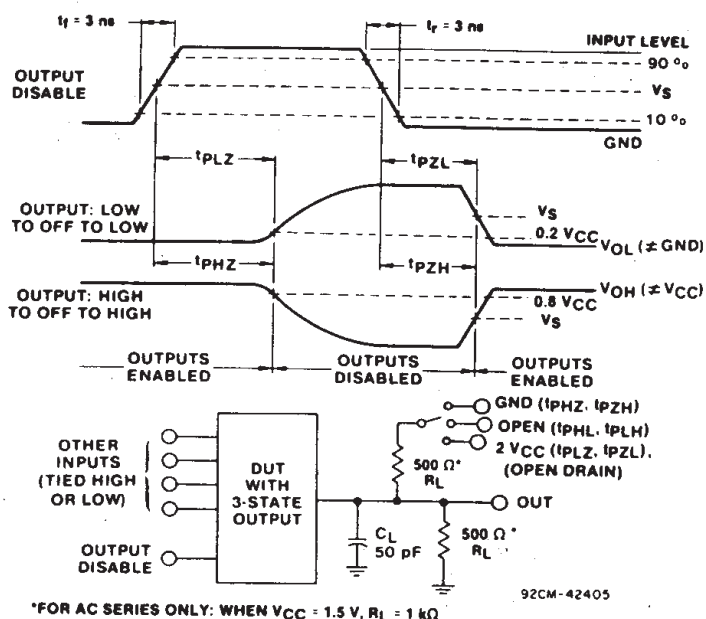

92CM-42405

Fig. 1 - Simultaneous switching transient waveforms.

Fig. 2 - Three-state propagation delay times and test circuit.

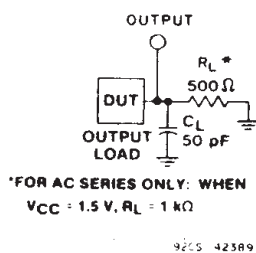

92CS-42389

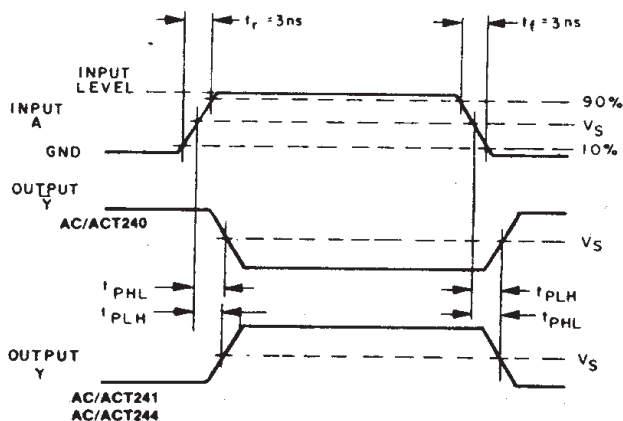

92CS-42407

Fig. 3 - Propagation delay times and test circuit.

| | CD54/74AC | CD54/74ACT |
|---------------------------------|--------------|--------------|
| Input Level | V_{CC} | 3 V |
| Input Switching Voltage, V_s | $0.5 V_{CC}$ | 1.5 V |
| Output Switching Voltage, V_s | $0.5 V_{CC}$ | $0.5 V_{CC}$ |

PACKAGING INFORMATION

| Orderable Device | Status (1) | Package Type | Package Drawing | Pins | Package Qty | Eco Plan (2) | Lead/Ball Finish (6) | MSL Peak Temp (3) | Op Temp (°C) | Device Marking (4/5) | Samples |
|------------------|---------------|--------------|--------------------|------|----------------|----------------------------|-------------------------|----------------------|--------------|-------------------------|-------------------------|
| CD54AC240F3A | ACTIVE | CDIP | J | 20 | 1 | TBD | A42 | N / A for Pkg Type | -55 to 125 | CD54AC240F3A | Samples |
| CD54AC244F3A | ACTIVE | CDIP | J | 20 | 1 | TBD | A42 | N / A for Pkg Type | -55 to 125 | CD54AC244F3A | Samples |
| CD54ACT240F3A | ACTIVE | CDIP | J | 20 | 1 | TBD | A42 | N / A for Pkg Type | -55 to 125 | CD54ACT240F3A | Samples |
| CD54ACT241F3A | ACTIVE | CDIP | J | 20 | 1 | TBD | A42 | N / A for Pkg Type | -55 to 125 | CD54ACT241F3A | Samples |
| CD54ACT244F3A | ACTIVE | CDIP | J | 20 | 1 | TBD | A42 | N / A for Pkg Type | -55 to 125 | CD54ACT244F3A | Samples |
| CD74AC240E | ACTIVE | PDIP | N | 20 | 20 | Pb-Free (RoHS) | CU NIPDAU | N / A for Pkg Type | -55 to 125 | CD74AC240E | Samples |
| CD74AC240EE4 | ACTIVE | PDIP | N | 20 | 20 | Pb-Free (RoHS) | CU NIPDAU | N / A for Pkg Type | -55 to 125 | CD74AC240E | Samples |
| CD74AC240M | ACTIVE | SOIC | DW | 20 | 25 | Green (RoHS & no Sb/Br) | CU NIPDAU | Level-1-260C-UNLIM | -55 to 125 | AC240M | Samples |
| CD74AC240M96 | ACTIVE | SOIC | DW | 20 | 2000 | Green (RoHS & no Sb/Br) | CU NIPDAU | Level-1-260C-UNLIM | -55 to 125 | AC240M | Samples |
| CD74AC244E | ACTIVE | PDIP | N | 20 | 20 | Pb-Free (RoHS) | CU NIPDAU | N / A for Pkg Type | -55 to 125 | CD74AC244E | Samples |
| CD74AC244EE4 | ACTIVE | PDIP | N | 20 | 20 | Pb-Free (RoHS) | CU NIPDAU | N / A for Pkg Type | -55 to 125 | CD74AC244E | Samples |
| CD74AC244M | ACTIVE | SOIC | DW | 20 | 25 | Green (RoHS & no Sb/Br) | CU NIPDAU | Level-1-260C-UNLIM | -55 to 125 | AC244M | Samples |
| CD74AC244M96 | ACTIVE | SOIC | DW | 20 | 2000 | Green (RoHS & no Sb/Br) | CU NIPDAU | Level-1-260C-UNLIM | -55 to 125 | AC244M | Samples |
| CD74AC244M96G4 | ACTIVE | SOIC | DW | 20 | 2000 | Green (RoHS & no Sb/Br) | CU NIPDAU | Level-1-260C-UNLIM | -55 to 125 | AC244M | Samples |
| CD74AC244SM96 | ACTIVE | SSOP | DB | 20 | 2000 | Green (RoHS & no Sb/Br) | CU NIPDAU | Level-1-260C-UNLIM | -55 to 125 | AC244SM | Samples |
| CD74ACT240E | ACTIVE | PDIP | N | 20 | 20 | Pb-Free (RoHS) | CU NIPDAU | N / A for Pkg Type | -55 to 125 | CD74ACT240E | Samples |
| CD74ACT240EE4 | ACTIVE | PDIP | N | 20 | 20 | Pb-Free (RoHS) | CU NIPDAU | N / A for Pkg Type | -55 to 125 | CD74ACT240E | Samples |
| CD74ACT240M | ACTIVE | SOIC | DW | 20 | 25 | Green (RoHS & no Sb/Br) | CU NIPDAU | Level-1-260C-UNLIM | -55 to 125 | ACT240M | Samples |

| Orderable Device | Status (1) | Package Type | Package Drawing | Pins | Package Qty | Eco Plan (2) | Lead/Ball Finish (6) | MSL Peak Temp (3) | Op Temp (°C) | Device Marking (4/5) | Samples |
|------------------|---------------|--------------|-----------------|------|-------------|-------------------------|-------------------------|----------------------|--------------|-------------------------|-------------------------|
| CD74ACT240M96 | ACTIVE | SOIC | DW | 20 | 2000 | Green (RoHS & no Sb/Br) | CU NIPDAU | Level-1-260C-UNLIM | -55 to 125 | ACT240M | Samples |
| CD74ACT240M96E4 | ACTIVE | SOIC | DW | 20 | 2000 | Green (RoHS & no Sb/Br) | CU NIPDAU | Level-1-260C-UNLIM | -55 to 125 | ACT240M | Samples |
| CD74ACT241E | ACTIVE | PDIP | N | 20 | 20 | Pb-Free (RoHS) | CU NIPDAU | N / A for Pkg Type | -55 to 125 | CD74ACT241E | Samples |
| CD74ACT241M96 | ACTIVE | SOIC | DW | 20 | 2000 | Green (RoHS & no Sb/Br) | CU NIPDAU | Level-1-260C-UNLIM | -55 to 125 | ACT241M | Samples |
| CD74ACT244E | ACTIVE | PDIP | N | 20 | 20 | Pb-Free (RoHS) | CU NIPDAU | N / A for Pkg Type | -55 to 125 | CD74ACT244E | Samples |
| CD74ACT244M | ACTIVE | SOIC | DW | 20 | 25 | Green (RoHS & no Sb/Br) | CU NIPDAU | Level-1-260C-UNLIM | -55 to 125 | ACT244M | Samples |
| CD74ACT244M96 | ACTIVE | SOIC | DW | 20 | 2000 | Green (RoHS & no Sb/Br) | CU NIPDAU | Level-1-260C-UNLIM | -55 to 125 | ACT244M | Samples |
| CD74ACT244M96E4 | ACTIVE | SOIC | DW | 20 | 2000 | Green (RoHS & no Sb/Br) | CU NIPDAU | Level-1-260C-UNLIM | -55 to 125 | ACT244M | Samples |
| CD74ACT244M96G4 | ACTIVE | SOIC | DW | 20 | 2000 | Green (RoHS & no Sb/Br) | CU NIPDAU | Level-1-260C-UNLIM | -55 to 125 | ACT244M | Samples |
| CD74ACT244MG4 | ACTIVE | SOIC | DW | 20 | 25 | Green (RoHS & no Sb/Br) | CU NIPDAU | Level-1-260C-UNLIM | -55 to 125 | ACT244M | Samples |
| CD74ACT244SM96 | ACTIVE | SSOP | DB | 20 | 2000 | Green (RoHS & no Sb/Br) | CU NIPDAU | Level-1-260C-UNLIM | -55 to 125 | ACT244SM | Samples |

(1) The marketing status values are defined as follows:

ACTIVE: Product device recommended for new designs.

LIFEBUY: TI has announced that the device will be discontinued, and a lifetime-buy period is in effect.

NRND: Not recommended for new designs. Device is in production to support existing customers, but TI does not recommend using this part in a new design.

PREVIEW: Device has been announced but is not in production. Samples may or may not be available.

OBSOLETE: TI has discontinued the production of the device.

(2) Eco Plan - The planned eco-friendly classification: Pb-Free (RoHS), Pb-Free (RoHS Exempt), or Green (RoHS & no Sb/Br) - please check <http://www.ti.com/productcontent> for the latest availability information and additional product content details.

TBD: The Pb-Free/Green conversion plan has not been defined.

Pb-Free (RoHS): TI's terms "Lead-Free" or "Pb-Free" mean semiconductor products that are compatible with the current RoHS requirements for all 6 substances, including the requirement that lead not exceed 0.1% by weight in homogeneous materials. Where designed to be soldered at high temperatures, TI Pb-Free products are suitable for use in specified lead-free processes.

Pb-Free (RoHS Exempt): This component has a RoHS exemption for either 1) lead-based flip-chip solder bumps used between the die and package, or 2) lead-based die adhesive used between the die and leadframe. The component is otherwise considered Pb-Free (RoHS compatible) as defined above.

Green (RoHS & no Sb/Br): TI defines "Green" to mean Pb-Free (RoHS compatible), and free of Bromine (Br) and Antimony (Sb) based flame retardants (Br or Sb do not exceed 0.1% by weight in homogeneous material)

(3) MSL, Peak Temp. - The Moisture Sensitivity Level rating according to the JEDEC industry standard classifications, and peak solder temperature.

(4) There may be additional marking, which relates to the logo, the lot trace code information, or the environmental category on the device.

(5) Multiple Device Markings will be inside parentheses. Only one Device Marking contained in parentheses and separated by a "~" will appear on a device. If a line is indented then it is a continuation of the previous line and the two combined represent the entire Device Marking for that device.

(6) Lead/Ball Finish - Orderable Devices may have multiple material finish options. Finish options are separated by a vertical ruled line. Lead/Ball Finish values may wrap to two lines if the finish value exceeds the maximum column width.

Important Information and Disclaimer: The information provided on this page represents TI's knowledge and belief as of the date that it is provided. TI bases its knowledge and belief on information provided by third parties, and makes no representation or warranty as to the accuracy of such information. Efforts are underway to better integrate information from third parties. TI has taken and continues to take reasonable steps to provide representative and accurate information but may not have conducted destructive testing or chemical analysis on incoming materials and chemicals. TI and TI suppliers consider certain information to be proprietary, and thus CAS numbers and other limited information may not be available for release.

In no event shall TI's liability arising out of such information exceed the total purchase price of the TI part(s) at issue in this document sold by TI to Customer on an annual basis.

OTHER QUALIFIED VERSIONS OF CD54AC240, CD54AC244, CD54ACT240, CD54ACT241, CD54ACT244, CD74AC240, CD74AC244, CD74ACT240, CD74ACT241, CD74ACT244 :

● Catalog: [CD74AC240](#), [CD74AC244](#), [CD74ACT240](#), [CD74ACT241](#), [CD74ACT244](#)

● Military: [CD54AC240](#), [CD54AC244](#), [CD54ACT240](#), [CD54ACT241](#), [CD54ACT244](#)

NOTE: Qualified Version Definitions:

- Catalog - TI's standard catalog product

- Military - QML certified for Military and Defense Applications

TAPE AND REEL INFORMATION
REEL DIMENSIONS

TAPE DIMENSIONS

| | |
|----|---|
| A0 | Dimension designed to accommodate the component width |
| B0 | Dimension designed to accommodate the component length |
| K0 | Dimension designed to accommodate the component thickness |
| W | Overall width of the carrier tape |
| P1 | Pitch between successive cavity centers |

TAPE AND REEL INFORMATION

*All dimensions are nominal

| Device | Package Type | Package Drawing | Pins | SPQ | Reel Diameter (mm) | Reel Width W1 (mm) | A0 (mm) | B0 (mm) | K0 (mm) | P1 (mm) | W (mm) | Pin1 Quadrant |
|----------------|--------------|-----------------|------|------|--------------------|--------------------|---------|---------|---------|---------|--------|---------------|
| CD74AC240M96 | SOIC | DW | 20 | 2000 | 330.0 | 24.4 | 10.8 | 13.0 | 2.7 | 12.0 | 24.0 | Q1 |
| CD74AC244M96 | SOIC | DW | 20 | 2000 | 330.0 | 24.4 | 10.8 | 13.0 | 2.7 | 12.0 | 24.0 | Q1 |
| CD74AC244SM96 | SSOP | DB | 20 | 2000 | 330.0 | 16.4 | 8.2 | 7.5 | 2.5 | 12.0 | 16.0 | Q1 |
| CD74ACT240M96 | SOIC | DW | 20 | 2000 | 330.0 | 24.4 | 10.8 | 13.0 | 2.7 | 12.0 | 24.0 | Q1 |
| CD74ACT241M96 | SOIC | DW | 20 | 2000 | 330.0 | 24.4 | 10.8 | 13.0 | 2.7 | 12.0 | 24.0 | Q1 |
| CD74ACT244M96 | SOIC | DW | 20 | 2000 | 330.0 | 24.4 | 10.8 | 13.0 | 2.7 | 12.0 | 24.0 | Q1 |
| CD74ACT244SM96 | SSOP | DB | 20 | 2000 | 330.0 | 16.4 | 8.2 | 7.5 | 2.5 | 12.0 | 16.0 | Q1 |

TAPE AND REEL BOX DIMENSIONS

*All dimensions are nominal

| Device | Package Type | Package Drawing | Pins | SPQ | Length (mm) | Width (mm) | Height (mm) |
|----------------|--------------|-----------------|------|------|-------------|------------|-------------|
| CD74AC240M96 | SOIC | DW | 20 | 2000 | 367.0 | 367.0 | 45.0 |
| CD74AC244M96 | SOIC | DW | 20 | 2000 | 367.0 | 367.0 | 45.0 |
| CD74AC244SM96 | SSOP | DB | 20 | 2000 | 367.0 | 367.0 | 38.0 |
| CD74ACT240M96 | SOIC | DW | 20 | 2000 | 367.0 | 367.0 | 45.0 |
| CD74ACT241M96 | SOIC | DW | 20 | 2000 | 367.0 | 367.0 | 45.0 |
| CD74ACT244M96 | SOIC | DW | 20 | 2000 | 367.0 | 367.0 | 45.0 |
| CD74ACT244SM96 | SSOP | DB | 20 | 2000 | 367.0 | 367.0 | 38.0 |

J (R-GDIP-T**)

14 LEADS SHOWN

CERAMIC DUAL IN-LINE PACKAGE



| DIM \ PINS ** | 14 | 16 | 18 | 20 |
|---------------|------------------------|------------------------|------------------------|------------------------|
| A | 0.300 (7,62) BSC | 0.300 (7,62) BSC | 0.300 (7,62) BSC | 0.300 (7,62) BSC |
| B MAX | 0.785 (19,94) | .840 (21,34) | 0.960 (24,38) | 1.060 (26,92) |
| B MIN | — | — | — | — |
| C MAX | 0.300 (7,62) | 0.300 (7,62) | 0.310 (7,87) | 0.300 (7,62) |
| C MIN | 0.245 (6,22) | 0.245 (6,22) | 0.220 (5,59) | 0.245 (6,22) |



4040083/F 03/03

- NOTES:
- All linear dimensions are in inches (millimeters).
 - This drawing is subject to change without notice.
 - This package is hermetically sealed with a ceramic lid using glass frit.
 - Index point is provided on cap for terminal identification only on press ceramic glass frit seal only.
 - Falls within MIL STD 1835 GDIP1-T14, GDIP1-T16, GDIP1-T18 and GDIP1-T20.

N (R-PDIP-T**)

PLASTIC DUAL-IN-LINE PACKAGE

16 PINS SHOWN



- NOTES:
- A. All linear dimensions are in inches (millimeters).
 - B. This drawing is subject to change without notice.
 - Falls within JEDEC MS-001, except 18 and 20 pin minimum body length (Dim A).
 - The 20 pin end lead shoulder width is a vendor option, either half or full width.

DW (R-PDSO-G20)

PLASTIC SMALL OUTLINE



- NOTES:
- A. All linear dimensions are in inches (millimeters). Dimensioning and tolerancing per ASME Y14.5M-1994.
 - B. This drawing is subject to change without notice.
 - C. Body dimensions do not include mold flash or protrusion not to exceed 0.006 (0,15).
 - D. Falls within JEDEC MS-013 variation AC.

DW (R-PDSO-G20)

PLASTIC SMALL OUTLINE

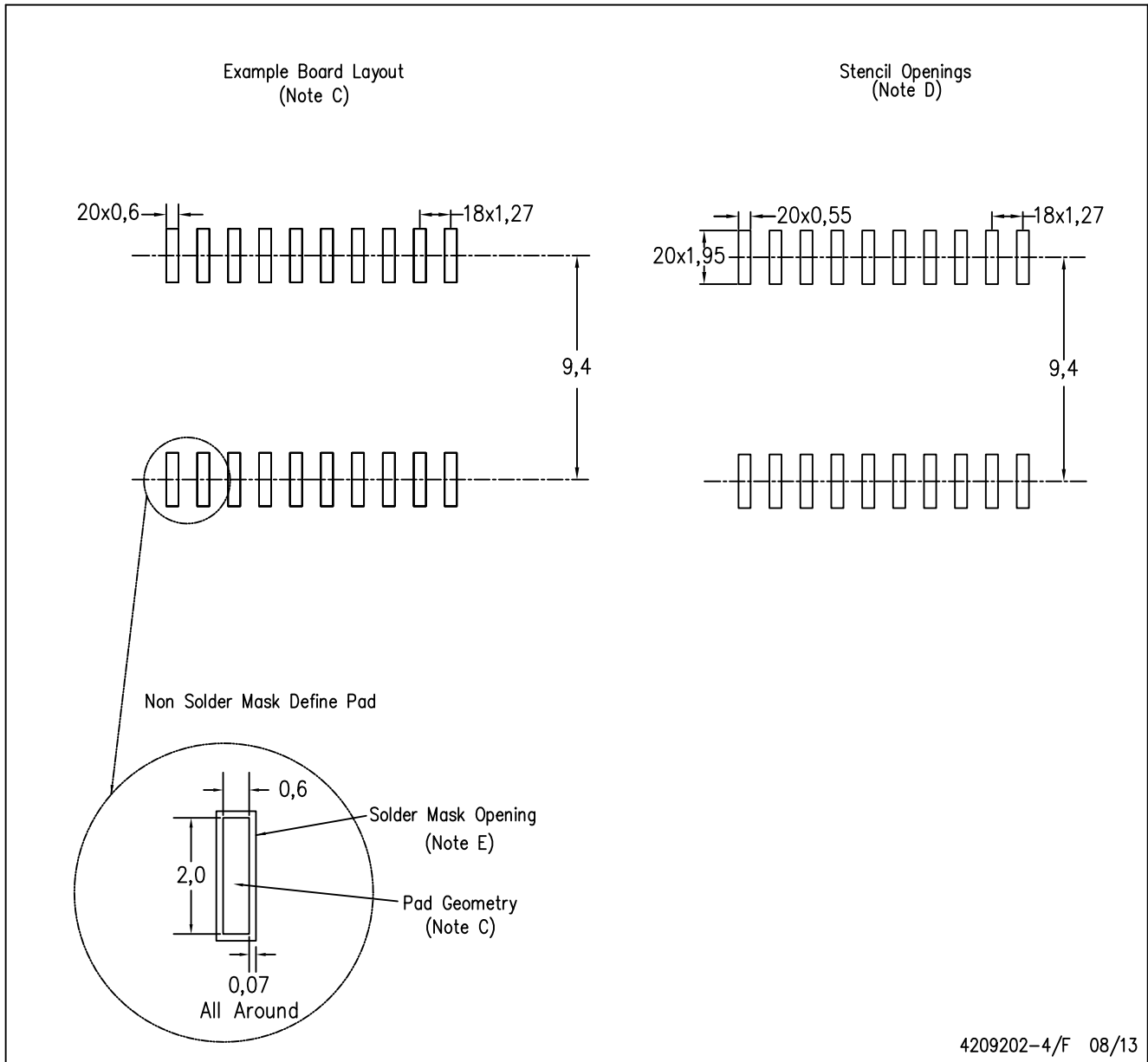

4209202-4/F 08/13

- NOTES:
- A. All linear dimensions are in millimeters.
 - B. This drawing is subject to change without notice.
 - C. Refer to IPC7351 for alternate board design.
 - D. Laser cutting apertures with trapezoidal walls and also rounding corners will offer better paste release. Customers should contact their board assembly site for stencil design recommendations. Refer to IPC-7525
 - E. Customers should contact their board fabrication site for solder mask tolerances between and around signal pads.

DB (R-PDSO-G**)

PLASTIC SMALL-OUTLINE

28 PINS SHOWN



- NOTES: A. All linear dimensions are in millimeters.
 B. This drawing is subject to change without notice.
 C. Body dimensions do not include mold flash or protrusion not to exceed 0,15.
 D. Falls within JEDEC MO-150

IMPORTANT NOTICE

Texas Instruments Incorporated and its subsidiaries (TI) reserve the right to make corrections, enhancements, improvements and other changes to its semiconductor products and services per JESD46, latest issue, and to discontinue any product or service per JESD48, latest issue. Buyers should obtain the latest relevant information before placing orders and should verify that such information is current and complete. All semiconductor products (also referred to herein as "components") are sold subject to TI's terms and conditions of sale supplied at the time of order acknowledgment.

TI warrants performance of its components to the specifications applicable at the time of sale, in accordance with the warranty in TI's terms and conditions of sale of semiconductor products. Testing and other quality control techniques are used to the extent TI deems necessary to support this warranty. Except where mandated by applicable law, testing of all parameters of each component is not necessarily performed.

TI assumes no liability for applications assistance or the design of Buyers' products. Buyers are responsible for their products and applications using TI components. To minimize the risks associated with Buyers' products and applications, Buyers should provide adequate design and operating safeguards.

TI does not warrant or represent that any license, either express or implied, is granted under any patent right, copyright, mask work right, or other intellectual property right relating to any combination, machine, or process in which TI components or services are used. Information published by TI regarding third-party products or services does not constitute a license to use such products or services or a warranty or endorsement thereof. Use of such information may require a license from a third party under the patents or other intellectual property of the third party, or a license from TI under the patents or other intellectual property of TI.

Reproduction of significant portions of TI information in TI data books or data sheets is permissible only if reproduction is without alteration and is accompanied by all associated warranties, conditions, limitations, and notices. TI is not responsible or liable for such altered documentation. Information of third parties may be subject to additional restrictions.

Resale of TI components or services with statements different from or beyond the parameters stated by TI for that component or service voids all express and any implied warranties for the associated TI component or service and is an unfair and deceptive business practice. TI is not responsible or liable for any such statements.

Buyer acknowledges and agrees that it is solely responsible for compliance with all legal, regulatory and safety-related requirements concerning its products, and any use of TI components in its applications, notwithstanding any applications-related information or support that may be provided by TI. Buyer represents and agrees that it has all the necessary expertise to create and implement safeguards which anticipate dangerous consequences of failures, monitor failures and their consequences, lessen the likelihood of failures that might cause harm and take appropriate remedial actions. Buyer will fully indemnify TI and its representatives against any damages arising out of the use of any TI components in safety-critical applications.

In some cases, TI components may be promoted specifically to facilitate safety-related applications. With such components, TI's goal is to help enable customers to design and create their own end-product solutions that meet applicable functional safety standards and requirements. Nonetheless, such components are subject to these terms.

No TI components are authorized for use in FDA Class III (or similar life-critical medical equipment) unless authorized officers of the parties have executed a special agreement specifically governing such use.

Only those TI components which TI has specifically designated as military grade or "enhanced plastic" are designed and intended for use in military/aerospace applications or environments. Buyer acknowledges and agrees that any military or aerospace use of TI components which have **not** been so designated is solely at the Buyer's risk, and that Buyer is solely responsible for compliance with all legal and regulatory requirements in connection with such use.

TI has specifically designated certain components as meeting ISO/TS16949 requirements, mainly for automotive use. In any case of use of non-designated products, TI will not be responsible for any failure to meet ISO/TS16949.

Products

| | |
|------------------------------|--|
| Audio | www.ti.com/audio |
| Amplifiers | amplifier.ti.com |
| Data Converters | dataconverter.ti.com |
| DLP® Products | www.dlp.com |
| DSP | dsp.ti.com |
| Clocks and Timers | www.ti.com/clocks |
| Interface | interface.ti.com |
| Logic | logic.ti.com |
| Power Mgmt | power.ti.com |
| Microcontrollers | microcontroller.ti.com |
| RFID | www.ti-rfid.com |
| OMAP Applications Processors | www.ti.com/omap |
| Wireless Connectivity | www.ti.com/wirelessconnectivity |

Applications

| | |
|-------------------------------|--|
| Automotive and Transportation | www.ti.com/automotive |
| Communications and Telecom | www.ti.com/communications |
| Computers and Peripherals | www.ti.com/computers |
| Consumer Electronics | www.ti.com/consumer-apps |
| Energy and Lighting | www.ti.com/energy |
| Industrial | www.ti.com/industrial |
| Medical | www.ti.com/medical |
| Security | www.ti.com/security |
| Space, Avionics and Defense | www.ti.com/space-avionics-defense |
| Video and Imaging | www.ti.com/video |

TI E2E Community

e2e.ti.com