

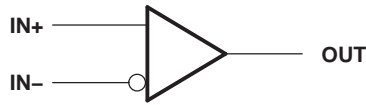

**Table 1. ORDERING INFORMATION<sup>(1)</sup>**

$T_A$	$V_{IOmax}$ AT 25°C	MAX $V_{CC}$	PACKAGE <sup>(2)</sup>		ORDERABLE PART NUMBER	TOP-SIDE MARKING
0°C to 70°C	5 mV	30 V	PDIP – N	Tube of 25	LM339N	LM339N
			SOIC – D	Tube of 50	LM339D	LM339
				Reel of 2500	LM339DR	
					LM339DRG3	
			SOP – NS	Reel of 2000	LM339NSR	LM339
			SSOP – DB	Reel of 2000	LM339DBR	LM339
	TSSOP – PW	Tube of 90	LM339PW	L339		
		Reel of 2000	LM339PWRG3			
	2 mV	30 V	PDIP – N	Tube of 25	LM339AN	LM339AN
			SOIC – D	Tube of 50	LM339AD	LM339A
				Reel of 2500	LM339ADR	
			SOP – NS	Reel of 2000	LM339ANSR	LM339A
SSOP – DB			Reel of 2000	LM339ADBR	L339A	
TSSOP – PW			Tube of 90	LM339APW	L339A	
	Reel of 2000	LM339APWR				
–25°C to 85°C	5 mV	30 V	PDIP – N	Tube of 25	LM239N	LM239N
			SOIC – D	Tube of 50	LM239D	LM239
				Reel of 2500	LM239DR	
					LM239DRG3	
	TSSOP – PW	Tube of 90	LM239PW	L239		
		Reel of 2000	LM239PWR			
	2 mV	30 V	SOIC – D	Tube of 50	LM239AD	LM239A
			Reel of 2500	LM239ADR		
–40°C to 125°C	7 mV	30 V	PDIP – N	Tube of 25	LM2901N	LM2901N
			SOIC – D	Tube of 50	LM2901D	LM2901
				Reel of 2500	LM2901DR	
					LM2901DRG3	
	SOP – NS	Reel of 2000	LM2901NSR	LM2901		
	TSSOP – PW	Tube of 90	LM2901PW	L2901		
		Reel of 2000	LM2901PWRG3			
	7 mV	32 V	SOIC – D	Reel of 2500	LM2901VQDR	L2901V
			TSSOP – PW	Reel of 2000	LM2901VQPWR	L2901V
	2 mV	32 V	SOIC – D	Reel of 2500	LM2901AVQDR	L2901AV
TSSOP – PW			Reel of 2000	LM2901AVQPWR	L2901AV	
–55°C to 125°C	5 mV	30 V	CFP – W	Tube of 25	LM139W	LM139W
			CDIP – J	Tube of 25	LM139J	LM139J
			LCCC – FK	Tube of 55	LM139FK	LM139FK
			SOIC – D	Tube of 50	LM139D	LM139
	Reel of 2500	LM139DR				
	2 mV	30 V	CFP – W	Tube of 25	LM139AW	LM139AW
			CDIP – J	Tube of 25	LM139AJ	LM139AJ
			LCCC – FK	Tube of 55	LM139AFK	LM139AFK
			SOIC – D	Tube of 50	LM139AD	LM139AD
	Reel of 2500	LM139ADR				

(1) For the most current package and ordering information, see the Package Option Addendum at the end of this document, or see the TI web site at [www.ti.com](http://www.ti.com).  
 (2) Package drawings, thermal data, and symbolization are available at [www.ti.com/packaging](http://www.ti.com/packaging).

**SYMBOL (EACH COMPARATOR)**



**SCHEMATIC (EACH COMPARATOR)**

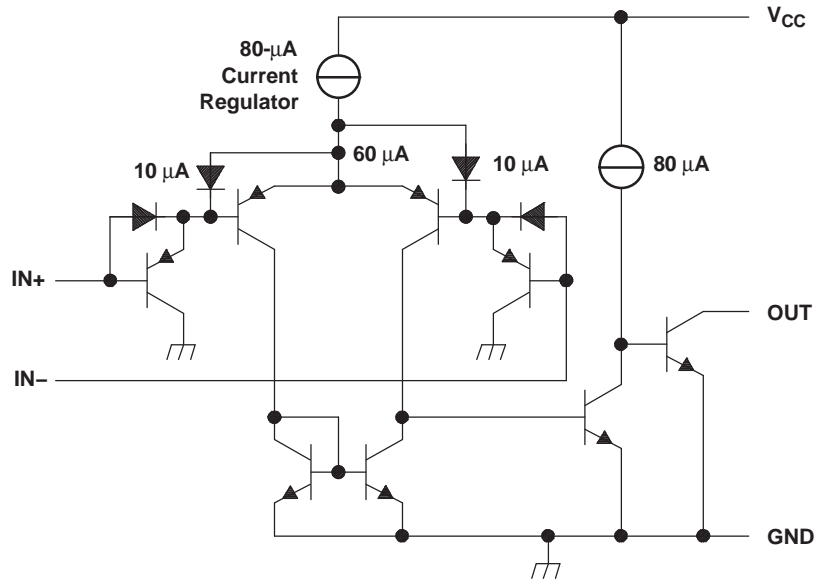

All current values shown are nominal.

## ABSOLUTE MAXIMUM RATINGS<sup>(1)</sup>

over operating free-air temperature range (unless otherwise noted)

		MIN	MAX	UNIT
V <sub>CC</sub>	Supply voltage <sup>(2)</sup>		36	V
V <sub>ID</sub>	Differential input voltage <sup>(3)</sup>		±36	V
V <sub>I</sub>	Input voltage range (either input)	-0.3	36	V
V <sub>O</sub>	Output voltage		36	V
I <sub>O</sub>	Output current		20	mA
Duration of output short circuit to ground <sup>(4)</sup>			Unlimited	
θ <sub>JA</sub>	Package thermal impedance, junction to free air <sup>(5)</sup> (6)	D package	86	°C/W
		DB package	96	
		N package	80	
		NS package	76	
		PW package	113	
θ <sub>JC</sub>	Package thermal impedance, junction to case <sup>(7)</sup> (8)	FK package	5.61	°C/W
		J package	15.05	
		W package	14.65	
T <sub>J</sub>	Operating virtual-junction temperature		150	°C
	Case temperature for 60 s	FK package	260	°C
	Lead temperature 1,6 mm (1/16 in) from case for 60 s	J package	300	°C
T <sub>stg</sub>	Storage temperature range	-65	150	°C

- (1) Stresses beyond those listed under "absolute maximum ratings" may cause permanent damage to the device. These are stress ratings only, and functional operation of the device at these or any other conditions beyond those indicated under "recommended operating conditions" is not implied. Exposure to absolute-maximum-rated conditions for extended periods may affect device reliability.
- (2) All voltage values, except differential voltages, are with respect to network ground.
- (3) Differential voltages are at IN+ with respect to IN-.
- (4) Short circuits from outputs to V<sub>CC</sub> can cause excessive heating and eventual destruction.
- (5) Maximum power dissipation is a function of T<sub>J</sub> (max), θ<sub>JA</sub>, and T<sub>A</sub>. The maximum allowable power dissipation at any allowable ambient temperature is P<sub>D</sub> = (T<sub>J</sub> (max) - T<sub>A</sub>)/θ<sub>JA</sub>. Operating at the absolute maximum T<sub>J</sub> of 150°C can affect reliability.
- (6) The package thermal impedance is calculated in accordance with JEDEC 51-7.
- (7) Maximum power dissipation is a function of T<sub>J</sub> (max), θ<sub>JC</sub>, and T<sub>C</sub>. The maximum allowable power dissipation at any allowable case temperature is P<sub>D</sub> = (T<sub>J</sub> (max) - T<sub>C</sub>)/θ<sub>JC</sub>. Operating at the absolute maximum T<sub>J</sub> of 150°C can affect reliability.
- (8) The package thermal impedance is calculated in accordance with MIL-STD-883.

## ELECTRICAL CHARACTERISTICS

 at specified free-air temperature,  $V_{CC} = 5\text{ V}$  (unless otherwise noted)

PARAMETER	TEST CONDITIONS <sup>(1)</sup>	$T_A$ <sup>(2)</sup>	LM139			LM139A			UNIT
			MIN	TYP	MAX	MIN	TYP	MAX	
$V_{IO}$ Input offset voltage	$V_{CC} = 5\text{ V to }30\text{ V}$ , $V_{IC} = V_{ICR}\text{ min}$ , $V_O = 1.4\text{ V}$	25°C		2	5		1	2	mV
		Full range			9			4	
$I_{IO}$ Input offset current	$V_O = 1.4\text{ V}$	25°C		3	25		3	25	nA
		Full range			100			100	
$I_{IB}$ Input bias current	$V_O = 1.4\text{ V}$	25°C		-25	-100		-25	-100	nA
		Full range			-300			-300	
$V_{ICR}$ Common-mode input-voltage range <sup>(3)</sup>		25°C		0 to $V_{CC} - 1.5$			0 to $V_{CC} - 1.5$		V
		Full range		0 to $V_{CC} - 2$			0 to $V_{CC} - 2$		
$A_{VD}$ Large-signal differential-voltage amplification	$V_{CC+} = \pm 7.5\text{ V}$ , $V_O = -5\text{ V to }5\text{ V}$	25°C		200		50	200	V/mV	
$I_{OH}$ High-level output current	$V_{ID} = 1\text{ V}$	$V_{OH} = 5\text{ V}$	25°C		0.1		0.1	nA	
		$V_{OH} = 30\text{ V}$	Full range			1		1	$\mu\text{A}$
$V_{OL}$ Low-level output voltage	$V_{ID} = -1\text{ V}$ , $I_{OL} = 4\text{ mA}$	25°C		150	400		150	400	mV
		Full range			700			700	
$I_{OL}$ Low-level output current	$V_{ID} = -1\text{ V}$ , $V_{OL} = 1.5\text{ V}$	25°C		6	16		6	16	mA
$I_{CC}$ Supply current (four comparators)	$V_O = 2.5\text{ V}$ , No load	25°C		0.8	2		0.8	2	mA

- (1) All characteristics are measured with zero common-mode input voltage, unless otherwise specified.
- (2) Full range (MIN to MAX) for LM139 and LM139A is  $-55^\circ\text{C}$  to  $125^\circ\text{C}$ . All characteristics are measured with zero common-mode input voltage, unless otherwise specified.
- (3) The voltage at either input or common-mode should not be allowed to go negative by more than 0.3 V. The upper end of the common-mode voltage range is  $V_{CC+} - 1.5\text{ V}$ ; however, one input can exceed  $V_{CC}$ , and the comparator will provide a proper output state as long as the other input remains in the common-mode range. Either or both inputs can go to 30 V without damage.

## SWITCHING CHARACTERISTICS

 $V_{CC} = 5\text{ V}$ ,  $T_A = 25^\circ\text{C}$ 

PARAMETER	TEST CONDITIONS	LM139 LM139A	UNIT	
		TYP		
Response time	$R_L$ connected to 5 V through 5.1 k $\Omega$ , $C_L = 15\text{ pF}$ <sup>(1) (2)</sup>	100-mV input step with 5-mV overdrive	1.3	$\mu\text{s}$
		TTL-level input step	0.3	

- (1)  $C_L$  includes probe and jig capacitance.
- (2) The response time specified is the interval between the input step function and the instant when the output crosses 1.4 V.

## ELECTRICAL CHARACTERISTICS

at specified free-air temperature,  $V_{CC} = 5\text{ V}$  (unless otherwise noted)

PARAMETER	TEST CONDITIONS <sup>(1)</sup>	$T_A$ <sup>(2)</sup>	LM239 LM339			LM239A LM339A			UNIT	
			MIN	TYP	MAX	MIN	TYP	MAX		
$V_{IO}$ Input offset voltage	$V_{CC} = 5\text{ V to }30\text{ V}$ , $V_{IC} = V_{ICR\text{ min}}$ , $V_O = 1.4\text{ V}$	25°C		2	5		1	3	mV	
		Full range			9			4		
$I_{IO}$ Input offset current	$V_O = 1.4\text{ V}$	25°C		5	50		5	50	nA	
		Full range			150			150		
$I_{IB}$ Input bias current	$V_O = 1.4\text{ V}$	25°C		-25	-250		-25	-250	nA	
		Full range			-400			-400		
$V_{ICR}$ Common-mode input-voltage range <sup>(3)</sup>		25°C	0 to $V_{CC} - 1.5$			0 to $V_{CC} - 1.5$			V	
		Full range	0 to $V_{CC} - 2$			0 to $V_{CC} - 2$				
$A_{VD}$ Large-signal differential-voltage amplification	$V_{CC} = 15\text{ V}$ , $V_O = 1.4\text{ V to }11.4\text{ V}$ , $R_L \geq 15\text{ k}\Omega\text{ to }V_{CC}$	25°C		50	200		50	200	V/mV	
$I_{OH}$ High-level output current	$V_{ID} = 1\text{ V}$	$V_{OH} = 5\text{ V}$	25°C		0.1	50		0.1	50	nA
		$V_{OH} = 30\text{ V}$	Full range			1			1	$\mu\text{A}$
$V_{OL}$ Low-level output voltage	$V_{ID} = -1\text{ V}$ , $I_{OL} = 4\text{ mA}$	25°C		150	400		150	400	mV	
		Full range			700			700		
$I_{OL}$ Low-level output current	$V_{ID} = -1\text{ V}$ , $V_{OL} = 1.5\text{ V}$	25°C		6	16		6	16	mA	
$I_{CC}$ Supply current (four comparators)	$V_O = 2.5\text{ V}$ , No load	25°C		0.8	2		0.8	2	mA	

- (1) All characteristics are measured with zero common-mode input voltage, unless otherwise specified.  
 (2) Full range (MIN to MAX) for LM239/LM239A is  $-25^\circ\text{C}$  to  $85^\circ\text{C}$ , and for LM339/LM339A is  $0^\circ\text{C}$  to  $70^\circ\text{C}$ . All characteristics are measured with zero common-mode input voltage, unless otherwise specified.  
 (3) The voltage at either input or common-mode should not be allowed to go negative by more than 0.3 V. The upper end of the common-mode voltage range is  $V_{CC+} - 1.5\text{ V}$ ; however, one input can exceed  $V_{CC}$ , and the comparator will provide a proper output state as long as the other input remains in the common-mode range. Either or both inputs can go to 30 V without damage.

## SWITCHING CHARACTERISTICS

$V_{CC} = 5\text{ V}$ ,  $T_A = 25^\circ\text{C}$

PARAMETER	TEST CONDITIONS	LM239 LM239A LM339 LM339A		UNIT
		TYP		
Response time	$R_L$ connected to 5 V through 5.1 k $\Omega$ , $C_L = 15\text{ pF}$ <sup>(1) (2)</sup>	100-mV input step with 5-mV overdrive		1.3
		TTL-level input step		0.3

- (1)  $C_L$  includes probe and jig capacitance.  
 (2) The response time specified is the interval between the input step function and the instant when the output crosses 1.4 V.

## ELECTRICAL CHARACTERISTICS

 at specified free-air temperature,  $V_{CC} = 5\text{ V}$  (unless otherwise noted)

PARAMETER	TEST CONDITIONS <sup>(1)</sup>		$T_A$ <sup>(2)</sup>	LM2901			UNIT
				MIN	TYP	MAX	
$V_{IO}$ Input offset voltage	$V_{IC} = V_{ICR\ min}$ , $V_O = 1.4\text{ V}$ , $V_{CC} = 5\text{ V to MAX}^{(3)}$	Non-A devices	25°C	2	7	mV	
			Full range		15		
		A-suffix devices	25°C	1	2		
			Full range		4		
$I_{IO}$ Input offset current	$V_O = 1.4\text{ V}$		25°C	5	50	nA	
			Full range		200		
$I_{IB}$ Input bias current	$V_O = 1.4\text{ V}$		25°C	-25	-250	nA	
			Full range		-500		
$V_{ICR}$ Common-mode input-voltage range <sup>(4)</sup>			25°C	0 to $V_{CC} - 1.5$		V	
			Full range	0 to $V_{CC} - 2$			
$A_{VD}$ Large-signal differential-voltage amplification	$V_{CC} = 15\text{ V}$ , $V_O = 1.4\text{ V to } 11.4\text{ V}$ , $R_L \geq 15\text{ k}\Omega\text{ to } V_{CC}$		25°C	25	100	V/mV	
$I_{OH}$ High-level output current	$V_{ID} = 1\text{ V}$		$V_{OH} = 5\text{ V}$	25°C	0.1	50	nA
			$V_{OH} = V_{CC}\ MAX^{(3)}$	Full range		1	$\mu\text{A}$
$V_{OL}$ Low-level output voltage	$V_{ID} = -1\text{ V}$ , $I_{OL} = 4\text{ mA}$		Non-V devices	25°C	150	500	mV
			V-suffix devices		150	400	
			All devices		Full range		
$I_{OL}$ Low-level output current	$V_{ID} = -1\text{ V}$ ,	$V_{OL} = 1.5\text{ V}$	25°C	6	16	mA	
$I_{CC}$ Supply current (four comparators)	$V_O = 2.5\text{ V}$ , No load		$V_{CC} = 5\text{ V}$	25°C	0.8	2	mA
			$V_{CC} = MAX^{(3)}$		1	2.5	

- (1) All characteristics are measured with zero common-mode input voltage, unless otherwise specified.  
 (2) Full range (MIN to MAX) for LM2901 is  $-40^\circ\text{C}$  to  $125^\circ\text{C}$ . All characteristics are measured with zero common-mode input voltage, unless otherwise specified.  
 (3)  $V_{CC}\ MAX = 30\text{ V}$  for non-V devices, and  $32\text{ V}$  for V-suffix devices  
 (4) The voltage at either input or common-mode should not be allowed to go negative by more than  $0.3\text{ V}$ . The upper end of the common-mode voltage range is  $V_{CC+} - 1.5\text{ V}$ ; however, one input can exceed  $V_{CC}$ , and the comparator will provide a proper output state as long as the other input remains in the common-mode range. Either or both inputs can go to  $V_{CC}\ MAX$  without damage.

## SWITCHING CHARACTERISTICS

 $V_{CC} = 5\text{ V}$ ,  $T_A = 25^\circ\text{C}$ 

PARAMETER	TEST CONDITIONS		LM2901	UNIT
			TYP	
Response time	$R_L$ connected to $5\text{ V}$ through $5.1\text{ k}\Omega$ , $C_L = 15\text{ pF}^{(1)}\ (2)$	100-mV input step with 5-mV overdrive	1.3	$\mu\text{s}$
		TTL-level input step	0.3	

- (1)  $C_L$  includes probe and jig capacitance.  
 (2) The response time specified is the interval between the input step function and the instant when the output crosses  $1.4\text{ V}$ .

TYPICAL CHARACTERISTICS

SUPPLY CURRENT  
vs  
SUPPLY VOLTAGE

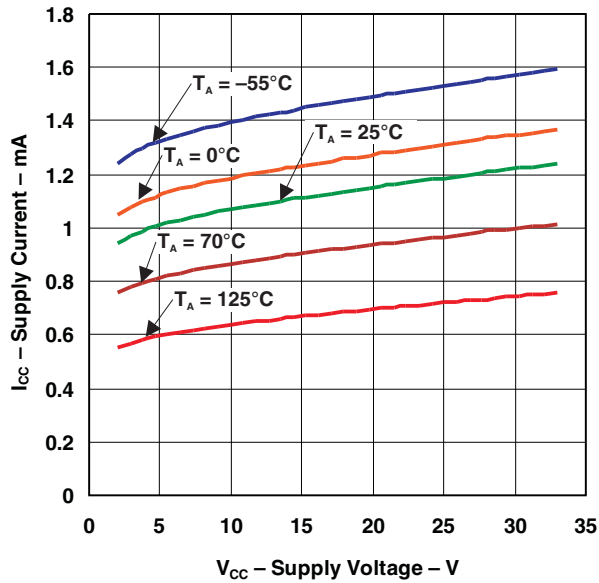

INPUT BIAS CURRENT  
vs  
SUPPLY VOLTAGE

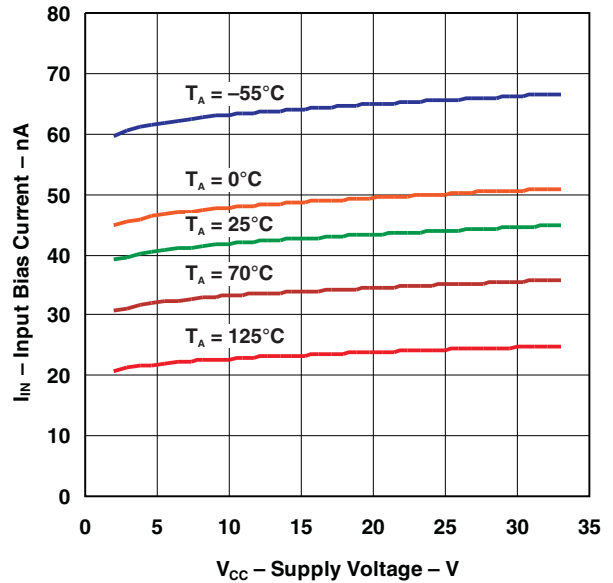

OUTPUT SATURATION VOLTAGE

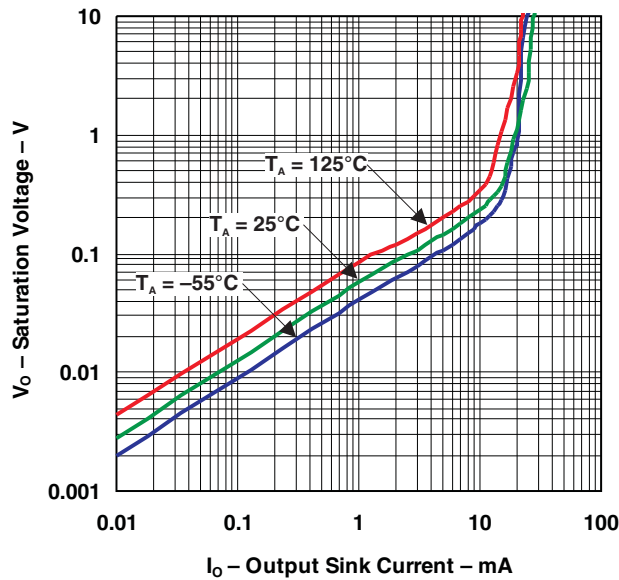



TYPICAL CHARACTERISTICS (continued)

RESPONSE TIME FOR VARIOUS OVERDRIVES  
NEGATIVE TRANSITION

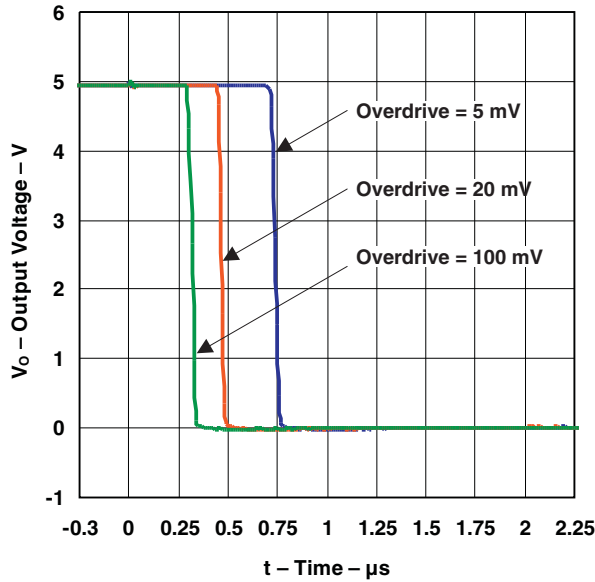

RESPONSE TIME FOR VARIOUS OVERDRIVES  
POSITIVE TRANSITION

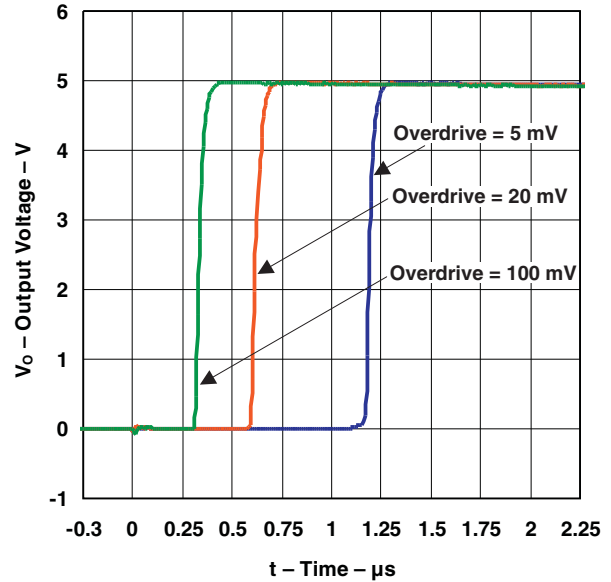

## REVISION HISTORY

Changes from Revision R (July 2010) to Revision S	Page
• Updated ORDERING INFORMATION table. ....	<a href="#">2</a>

**PACKAGING INFORMATION**

Orderable Device	Status (1)	Package Type	Package Drawing	Pins	Package Qty	Eco Plan (2)	Lead/Ball Finish (6)	MSL Peak Temp (3)	Op Temp (°C)	Device Marking (4/5)	Samples
5962-7700801VCA	ACTIVE	CDIP	J	14	1	TBD	A42	N / A for Pkg Type	-55 to 125	5962-7700801VC A LM139JQMLV	<a href="#">Samples</a>
5962-87739012A	ACTIVE	LCCC	FK	20	1	TBD	POST-PLATE	N / A for Pkg Type	-55 to 125	5962- 87739012A LM139AFKB	<a href="#">Samples</a>
5962-8773901CA	ACTIVE	CDIP	J	14	1	TBD	A42	N / A for Pkg Type	-55 to 125	5962-8773901CA LM139AJB	<a href="#">Samples</a>
5962-8773901DA	ACTIVE	CFP	W	14	1	TBD	A42	N / A for Pkg Type	-55 to 125	5962-8773901DA LM139AWB	<a href="#">Samples</a>
5962-9673802V9B	ACTIVE	XCEPT	KGD	0	100	TBD	Call TI	N / A for Pkg Type	-55 to 125		<a href="#">Samples</a>
5962-9673802VCA	ACTIVE	CDIP	J	14	1	TBD	A42	N / A for Pkg Type	-55 to 125	5962-9673802VC A LM139AJQMLV	<a href="#">Samples</a>
77008012A	ACTIVE	LCCC	FK	20	1	TBD	POST-PLATE	N / A for Pkg Type	-55 to 125	77008012A LM139FKB	<a href="#">Samples</a>
7700801CA	ACTIVE	CDIP	J	14	1	TBD	A42	N / A for Pkg Type	-55 to 125	7700801CA LM139JB	<a href="#">Samples</a>
7700801DA	ACTIVE	CFP	W	14	1	TBD	A42	N / A for Pkg Type	-55 to 125	7700801DA LM139WB	<a href="#">Samples</a>
JM38510/11201BCA	ACTIVE	CDIP	J	14	1	TBD	A42	N / A for Pkg Type	-55 to 125	JM38510 /11201BCA	<a href="#">Samples</a>
LM139AD	ACTIVE	SOIC	D	14	50	Green (RoHS & no Sb/Br)	CU NIPDAU	Level-1-260C-UNLIM	-55 to 125	LM139A	<a href="#">Samples</a>
LM139ADG4	ACTIVE	SOIC	D	14	50	Green (RoHS & no Sb/Br)	CU NIPDAU	Level-1-260C-UNLIM	-55 to 125	LM139A	<a href="#">Samples</a>
LM139ADR	ACTIVE	SOIC	D	14	2500	Green (RoHS & no Sb/Br)	CU NIPDAU	Level-1-260C-UNLIM	-55 to 125	LM139A	<a href="#">Samples</a>
LM139ADRG4	ACTIVE	SOIC	D	14	2500	Green (RoHS & no Sb/Br)	CU NIPDAU	Level-1-260C-UNLIM	-55 to 125	LM139A	<a href="#">Samples</a>
LM139AFKB	ACTIVE	LCCC	FK	20	1	TBD	POST-PLATE	N / A for Pkg Type	-55 to 125	5962- 87739012A LM139AFKB	<a href="#">Samples</a>
LM139AJ	ACTIVE	CDIP	J	14	1	TBD	A42	N / A for Pkg Type	-55 to 125	LM139AJ	<a href="#">Samples</a>

Orderable Device	Status (1)	Package Type	Package Drawing	Pins	Package Qty	Eco Plan (2)	Lead/Ball Finish (6)	MSL Peak Temp (3)	Op Temp (°C)	Device Marking (4/5)	Samples
LM139AJB	ACTIVE	CDIP	J	14	1	TBD	A42	N / A for Pkg Type	-55 to 125	5962-8773901CA LM139AJB	<a href="#">Samples</a>
LM139AN	OBSOLETE	PDIP	N	14		TBD	Call TI	Call TI	-55 to 125		
LM139AW	ACTIVE	CFP	W	14	1	TBD	A42	N / A for Pkg Type	-55 to 125	LM139AW	<a href="#">Samples</a>
LM139AWB	ACTIVE	CFP	W	14	1	TBD	A42	N / A for Pkg Type	-55 to 125	5962-8773901DA LM139AWB	<a href="#">Samples</a>
LM139D	ACTIVE	SOIC	D	14	50	Green (RoHS & no Sb/Br)	CU NIPDAU	Level-1-260C-UNLIM	-55 to 125	LM139	<a href="#">Samples</a>
LM139DG4	ACTIVE	SOIC	D	14	50	Green (RoHS & no Sb/Br)	CU NIPDAU	Level-1-260C-UNLIM	-55 to 125	LM139	<a href="#">Samples</a>
LM139DR	ACTIVE	SOIC	D	14	2500	Green (RoHS & no Sb/Br)	CU NIPDAU	Level-1-260C-UNLIM	-55 to 125	LM139	<a href="#">Samples</a>
LM139DRG4	ACTIVE	SOIC	D	14	2500	Green (RoHS & no Sb/Br)	CU NIPDAU	Level-1-260C-UNLIM	-55 to 125	LM139	<a href="#">Samples</a>
LM139FK	ACTIVE	LCCC	FK	20	1	TBD	POST-PLATE	N / A for Pkg Type	-55 to 125	LM139FK	<a href="#">Samples</a>
LM139FKB	ACTIVE	LCCC	FK	20	1	TBD	POST-PLATE	N / A for Pkg Type	-55 to 125	77008012A LM139FKB	<a href="#">Samples</a>
LM139J	ACTIVE	CDIP	J	14	1	TBD	A42	N / A for Pkg Type	-55 to 125	LM139J	<a href="#">Samples</a>
LM139JB	ACTIVE	CDIP	J	14	1	TBD	A42	N / A for Pkg Type	-55 to 125	7700801CA LM139JB	<a href="#">Samples</a>
LM139N	OBSOLETE	PDIP	N	14		TBD	Call TI	Call TI	-55 to 125		
LM139W	ACTIVE	CFP	W	14	1	TBD	A42	N / A for Pkg Type	-55 to 125	LM139W	<a href="#">Samples</a>
LM139WB	ACTIVE	CFP	W	14	1	TBD	A42	N / A for Pkg Type	-55 to 125	7700801DA LM139WB	<a href="#">Samples</a>
LM239AD	ACTIVE	SOIC	D	14	50	Green (RoHS & no Sb/Br)	CU NIPDAU	Level-1-260C-UNLIM	-25 to 85	LM239A	<a href="#">Samples</a>
LM239ADE4	ACTIVE	SOIC	D	14	50	Green (RoHS & no Sb/Br)	CU NIPDAU	Level-1-260C-UNLIM	-25 to 85	LM239A	<a href="#">Samples</a>
LM239ADG4	ACTIVE	SOIC	D	14	50	Green (RoHS & no Sb/Br)	CU NIPDAU	Level-1-260C-UNLIM	-25 to 85	LM239A	<a href="#">Samples</a>
LM239ADR	ACTIVE	SOIC	D	14	2500	Green (RoHS & no Sb/Br)	CU NIPDAU	Level-1-260C-UNLIM	-25 to 85	LM239A	<a href="#">Samples</a>

Orderable Device	Status (1)	Package Type	Package Drawing	Pins	Package Qty	Eco Plan (2)	Lead/Ball Finish (6)	MSL Peak Temp (3)	Op Temp (°C)	Device Marking (4/5)	Samples
LM239ADRE4	ACTIVE	SOIC	D	14	2500	Green (RoHS & no Sb/Br)	CU NIPDAU	Level-1-260C-UNLIM	-25 to 85	LM239A	<a href="#">Samples</a>
LM239ADRG4	ACTIVE	SOIC	D	14	2500	Green (RoHS & no Sb/Br)	CU NIPDAU	Level-1-260C-UNLIM	-25 to 85	LM239A	<a href="#">Samples</a>
LM239AN	OBSOLETE	PDIP	N	14		TBD	Call TI	Call TI	-25 to 85		
LM239D	ACTIVE	SOIC	D	14	50	Green (RoHS & no Sb/Br)	CU NIPDAU	Level-1-260C-UNLIM	-25 to 85	LM239	<a href="#">Samples</a>
LM239DE4	ACTIVE	SOIC	D	14	50	Green (RoHS & no Sb/Br)	CU NIPDAU	Level-1-260C-UNLIM	-25 to 85	LM239	<a href="#">Samples</a>
LM239DG4	ACTIVE	SOIC	D	14	50	Green (RoHS & no Sb/Br)	CU NIPDAU	Level-1-260C-UNLIM	-25 to 85	LM239	<a href="#">Samples</a>
LM239DR	ACTIVE	SOIC	D	14	2500	Green (RoHS & no Sb/Br)	CU NIPDAU   CU SN	Level-1-260C-UNLIM	-25 to 85	LM239	<a href="#">Samples</a>
LM239DRG3	ACTIVE	SOIC	D	14	2500	Green (RoHS & no Sb/Br)	CU SN	Level-1-260C-UNLIM	-25 to 85	LM239	<a href="#">Samples</a>
LM239DRG4	ACTIVE	SOIC	D	14	2500	Green (RoHS & no Sb/Br)	CU NIPDAU	Level-1-260C-UNLIM	-25 to 85	LM239	<a href="#">Samples</a>
LM239N	ACTIVE	PDIP	N	14	25	Pb-Free (RoHS)	CU NIPDAU	N / A for Pkg Type	-25 to 85	LM239N	<a href="#">Samples</a>
LM239NE4	ACTIVE	PDIP	N	14	25	Pb-Free (RoHS)	CU NIPDAU	N / A for Pkg Type	-25 to 85	LM239N	<a href="#">Samples</a>
LM239PW	ACTIVE	TSSOP	PW	14	90	Green (RoHS & no Sb/Br)	CU NIPDAU	Level-1-260C-UNLIM	-25 to 85	L239	<a href="#">Samples</a>
LM239PWG4	ACTIVE	TSSOP	PW	14	90	Green (RoHS & no Sb/Br)	CU NIPDAU	Level-1-260C-UNLIM	-25 to 85	L239	<a href="#">Samples</a>
LM239PWR	ACTIVE	TSSOP	PW	14	2000	Green (RoHS & no Sb/Br)	CU NIPDAU	Level-1-260C-UNLIM	-25 to 85	L239	<a href="#">Samples</a>
LM239PWRE4	ACTIVE	TSSOP	PW	14	2000	Green (RoHS & no Sb/Br)	CU NIPDAU	Level-1-260C-UNLIM	-25 to 85	L239	<a href="#">Samples</a>
LM239PWRG4	ACTIVE	TSSOP	PW	14	2000	Green (RoHS & no Sb/Br)	CU NIPDAU	Level-1-260C-UNLIM	-25 to 85	L239	<a href="#">Samples</a>
LM2901AVQDR	ACTIVE	SOIC	D	14	2500	Green (RoHS & no Sb/Br)	CU NIPDAU	Level-1-260C-UNLIM	-40 to 125	L2901AV	<a href="#">Samples</a>
LM2901AVQDRG4	ACTIVE	SOIC	D	14	2500	Green (RoHS & no Sb/Br)	CU NIPDAU	Level-1-260C-UNLIM	-40 to 125	L2901AV	<a href="#">Samples</a>

Orderable Device	Status (1)	Package Type	Package Drawing	Pins	Package Qty	Eco Plan (2)	Lead/Ball Finish (6)	MSL Peak Temp (3)	Op Temp (°C)	Device Marking (4/5)	Samples
LM2901AVQPWR	ACTIVE	TSSOP	PW	14	2000	Green (RoHS & no Sb/Br)	CU NIPDAU	Level-1-260C-UNLIM	-40 to 125	L2901AV	<a href="#">Samples</a>
LM2901AVQPWRG4	ACTIVE	TSSOP	PW	14	2000	Green (RoHS & no Sb/Br)	CU NIPDAU	Level-1-260C-UNLIM	-40 to 125	L2901AV	<a href="#">Samples</a>
LM2901D	ACTIVE	SOIC	D	14	50	Green (RoHS & no Sb/Br)	CU NIPDAU	Level-1-260C-UNLIM	-40 to 125	LM2901	<a href="#">Samples</a>
LM2901DE4	ACTIVE	SOIC	D	14	50	Green (RoHS & no Sb/Br)	CU NIPDAU	Level-1-260C-UNLIM	-40 to 125	LM2901	<a href="#">Samples</a>
LM2901DG4	ACTIVE	SOIC	D	14	50	Green (RoHS & no Sb/Br)	CU NIPDAU	Level-1-260C-UNLIM	-40 to 125	LM2901	<a href="#">Samples</a>
LM2901DR	ACTIVE	SOIC	D	14	2500	Green (RoHS & no Sb/Br)	CU NIPDAU   CU SN	Level-1-260C-UNLIM	-40 to 125	LM2901	<a href="#">Samples</a>
LM2901DRE4	ACTIVE	SOIC	D	14	2500	Green (RoHS & no Sb/Br)	CU NIPDAU	Level-1-260C-UNLIM	-40 to 125	LM2901	<a href="#">Samples</a>
LM2901DRG3	ACTIVE	SOIC	D	14	2500	Green (RoHS & no Sb/Br)	CU SN	Level-1-260C-UNLIM	-40 to 125	LM2901	<a href="#">Samples</a>
LM2901DRG4	ACTIVE	SOIC	D	14	2500	Green (RoHS & no Sb/Br)	CU NIPDAU	Level-1-260C-UNLIM	-40 to 125	LM2901	<a href="#">Samples</a>
LM2901N	ACTIVE	PDIP	N	14	25	Pb-Free (RoHS)	CU NIPDAU	N / A for Pkg Type	-40 to 125	LM2901N	<a href="#">Samples</a>
LM2901NE4	ACTIVE	PDIP	N	14	25	Pb-Free (RoHS)	CU NIPDAU	N / A for Pkg Type	-40 to 125	LM2901N	<a href="#">Samples</a>
LM2901NSR	ACTIVE	SO	NS	14	2000	Green (RoHS & no Sb/Br)	CU NIPDAU	Level-1-260C-UNLIM	-40 to 125	LM2901	<a href="#">Samples</a>
LM2901NSRG4	ACTIVE	SO	NS	14	2000	Green (RoHS & no Sb/Br)	CU NIPDAU	Level-1-260C-UNLIM	-40 to 125	LM2901	<a href="#">Samples</a>
LM2901PW	ACTIVE	TSSOP	PW	14	90	Green (RoHS & no Sb/Br)	CU NIPDAU	Level-1-260C-UNLIM	-40 to 125	L2901	<a href="#">Samples</a>
LM2901PWG4	ACTIVE	TSSOP	PW	14	90	Green (RoHS & no Sb/Br)	CU NIPDAU	Level-1-260C-UNLIM	-40 to 125	L2901	<a href="#">Samples</a>
LM2901PWLE	OBSOLETE	TSSOP	PW	14		TBD	Call TI	Call TI	-40 to 125		
LM2901PWR	ACTIVE	TSSOP	PW	14	2000	Green (RoHS & no Sb/Br)	CU NIPDAU   CU SN	Level-1-260C-UNLIM	-40 to 125	L2901	<a href="#">Samples</a>
LM2901PWRG3	ACTIVE	TSSOP	PW	14	2000	Green (RoHS & no Sb/Br)	CU SN	Level-1-260C-UNLIM	-40 to 125	L2901	<a href="#">Samples</a>

Orderable Device	Status (1)	Package Type	Package Drawing	Pins	Package Qty	Eco Plan (2)	Lead/Ball Finish (6)	MSL Peak Temp (3)	Op Temp (°C)	Device Marking (4/5)	Samples
LM2901PWRG4	ACTIVE	TSSOP	PW	14	2000	Green (RoHS & no Sb/Br)	CU NIPDAU	Level-1-260C-UNLIM	-40 to 125	L2901	<a href="#">Samples</a>
LM2901QD	OBSOLETE	SOIC	D	14		TBD	Call TI	Call TI	-40 to 125		
LM2901QN	OBSOLETE	PDIP	N	14		TBD	Call TI	Call TI	-40 to 125		
LM2901VQDR	ACTIVE	SOIC	D	14	2500	Green (RoHS & no Sb/Br)	CU NIPDAU	Level-1-260C-UNLIM	-40 to 125	L2901V	<a href="#">Samples</a>
LM2901VQDRG4	ACTIVE	SOIC	D	14	2500	Green (RoHS & no Sb/Br)	CU NIPDAU	Level-1-260C-UNLIM	-40 to 125	L2901V	<a href="#">Samples</a>
LM2901VQPWR	ACTIVE	TSSOP	PW	14	2000	Green (RoHS & no Sb/Br)	CU NIPDAU	Level-1-260C-UNLIM	-40 to 125	L2901V	<a href="#">Samples</a>
LM2901VQPWRG4	ACTIVE	TSSOP	PW	14	2000	Green (RoHS & no Sb/Br)	CU NIPDAU	Level-1-260C-UNLIM	-40 to 125	L2901V	<a href="#">Samples</a>
LM339AD	ACTIVE	SOIC	D	14	50	Green (RoHS & no Sb/Br)	CU NIPDAU	Level-1-260C-UNLIM	0 to 70	LM339A	<a href="#">Samples</a>
LM339ADBR	ACTIVE	SSOP	DB	14	2000	Green (RoHS & no Sb/Br)	CU NIPDAU	Level-1-260C-UNLIM	0 to 70	L339A	<a href="#">Samples</a>
LM339ADBRG4	ACTIVE	SSOP	DB	14	2000	Green (RoHS & no Sb/Br)	CU NIPDAU	Level-1-260C-UNLIM	0 to 70	L339A	<a href="#">Samples</a>
LM339ADE4	ACTIVE	SOIC	D	14	50	Green (RoHS & no Sb/Br)	CU NIPDAU	Level-1-260C-UNLIM	0 to 70	LM339A	<a href="#">Samples</a>
LM339ADG4	ACTIVE	SOIC	D	14	50	Green (RoHS & no Sb/Br)	CU NIPDAU	Level-1-260C-UNLIM	0 to 70	LM339A	<a href="#">Samples</a>
LM339ADR	ACTIVE	SOIC	D	14	2500	Green (RoHS & no Sb/Br)	CU NIPDAU   CU SN	Level-1-260C-UNLIM	0 to 70	LM339A	<a href="#">Samples</a>
LM339ADRE4	ACTIVE	SOIC	D	14	2500	Green (RoHS & no Sb/Br)	CU NIPDAU	Level-1-260C-UNLIM	0 to 70	LM339A	<a href="#">Samples</a>
LM339ADRG4	ACTIVE	SOIC	D	14	2500	Green (RoHS & no Sb/Br)	CU NIPDAU	Level-1-260C-UNLIM	0 to 70	LM339A	<a href="#">Samples</a>
LM339AN	ACTIVE	PDIP	N	14	25	Pb-Free (RoHS)	CU NIPDAU	N / A for Pkg Type	0 to 70	LM339AN	<a href="#">Samples</a>
LM339ANE4	ACTIVE	PDIP	N	14	25	Pb-Free (RoHS)	CU NIPDAU	N / A for Pkg Type	0 to 70	LM339AN	<a href="#">Samples</a>
LM339ANSR	ACTIVE	SO	NS	14	2000	Green (RoHS & no Sb/Br)	CU NIPDAU	Level-1-260C-UNLIM	0 to 70	LM339A	<a href="#">Samples</a>
LM339ANSRG4	ACTIVE	SO	NS	14	2000	Green (RoHS & no Sb/Br)	CU NIPDAU	Level-1-260C-UNLIM	0 to 70	LM339A	<a href="#">Samples</a>

Orderable Device	Status (1)	Package Type	Package Drawing	Pins	Package Qty	Eco Plan (2)	Lead/Ball Finish (6)	MSL Peak Temp (3)	Op Temp (°C)	Device Marking (4/5)	Samples
LM339APW	ACTIVE	TSSOP	PW	14	90	Green (RoHS & no Sb/Br)	CU NIPDAU	Level-1-260C-UNLIM	0 to 70	L339A	<a href="#">Samples</a>
LM339APWG4	ACTIVE	TSSOP	PW	14	90	Green (RoHS & no Sb/Br)	CU NIPDAU	Level-1-260C-UNLIM	0 to 70	L339A	<a href="#">Samples</a>
LM339APWR	ACTIVE	TSSOP	PW	14	2000	Green (RoHS & no Sb/Br)	CU NIPDAU	Level-1-260C-UNLIM	0 to 70	L339A	<a href="#">Samples</a>
LM339APWRE4	ACTIVE	TSSOP	PW	14	2000	Green (RoHS & no Sb/Br)	CU NIPDAU	Level-1-260C-UNLIM	0 to 70	L339A	<a href="#">Samples</a>
LM339APWRG4	ACTIVE	TSSOP	PW	14	2000	Green (RoHS & no Sb/Br)	CU NIPDAU	Level-1-260C-UNLIM	0 to 70	L339A	<a href="#">Samples</a>
LM339D	ACTIVE	SOIC	D	14	50	Green (RoHS & no Sb/Br)	CU NIPDAU	Level-1-260C-UNLIM	0 to 70	LM339	<a href="#">Samples</a>
LM339DBLE	OBSOLETE	SSOP	DB	14		TBD	Call TI	Call TI	0 to 70		
LM339DBR	ACTIVE	SSOP	DB	14	2000	Green (RoHS & no Sb/Br)	CU NIPDAU	Level-1-260C-UNLIM	0 to 70	LM339	<a href="#">Samples</a>
LM339DBRE4	ACTIVE	SSOP	DB	14	2000	Green (RoHS & no Sb/Br)	CU NIPDAU	Level-1-260C-UNLIM	0 to 70	LM339	<a href="#">Samples</a>
LM339DE4	ACTIVE	SOIC	D	14	50	Green (RoHS & no Sb/Br)	CU NIPDAU	Level-1-260C-UNLIM	0 to 70	LM339	<a href="#">Samples</a>
LM339DG4	ACTIVE	SOIC	D	14	50	Green (RoHS & no Sb/Br)	CU NIPDAU	Level-1-260C-UNLIM	0 to 70	LM339	<a href="#">Samples</a>
LM339DR	ACTIVE	SOIC	D	14	2500	Green (RoHS & no Sb/Br)	CU NIPDAU   CU SN	Level-1-260C-UNLIM	0 to 70	LM339	<a href="#">Samples</a>
LM339DRE4	ACTIVE	SOIC	D	14	2500	Green (RoHS & no Sb/Br)	CU NIPDAU	Level-1-260C-UNLIM	0 to 70	LM339	<a href="#">Samples</a>
LM339DRG3	ACTIVE	SOIC	D	14	2500	Green (RoHS & no Sb/Br)	CU SN	Level-1-260C-UNLIM	0 to 70	LM339	<a href="#">Samples</a>
LM339DRG4	ACTIVE	SOIC	D	14	2500	Green (RoHS & no Sb/Br)	CU NIPDAU	Level-1-260C-UNLIM	0 to 70	LM339	<a href="#">Samples</a>
LM339N	ACTIVE	PDIP	N	14	25	Pb-Free (RoHS)	CU NIPDAU   CU SN	N / A for Pkg Type	0 to 70	LM339N	<a href="#">Samples</a>
LM339NE3	ACTIVE	PDIP	N	14	25	Green (RoHS & no Sb/Br)	CU SN	Level-1-260C-UNLIM	0 to 70	LM339N	<a href="#">Samples</a>
LM339NE4	ACTIVE	PDIP	N	14	25	Pb-Free (RoHS)	CU NIPDAU	N / A for Pkg Type	0 to 70	LM339N	<a href="#">Samples</a>
LM339NSLE	OBSOLETE	SO	NS	14		TBD	Call TI	Call TI	0 to 70		



Orderable Device	Status (1)	Package Type	Package Drawing	Pins	Package Qty	Eco Plan (2)	Lead/Ball Finish (6)	MSL Peak Temp (3)	Op Temp (°C)	Device Marking (4/5)	Samples
LM339NSR	ACTIVE	SO	NS	14	2000	Green (RoHS & no Sb/Br)	CU NIPDAU	Level-1-260C-UNLIM	0 to 70	LM339	<a href="#">Samples</a>
LM339NSRG4	ACTIVE	SO	NS	14	2000	Green (RoHS & no Sb/Br)	CU NIPDAU	Level-1-260C-UNLIM	0 to 70	LM339	<a href="#">Samples</a>
LM339PW	ACTIVE	TSSOP	PW	14	90	Green (RoHS & no Sb/Br)	CU NIPDAU	Level-1-260C-UNLIM	0 to 70	L339	<a href="#">Samples</a>
LM339PWG4	ACTIVE	TSSOP	PW	14	90	Green (RoHS & no Sb/Br)	CU NIPDAU	Level-1-260C-UNLIM	0 to 70	L339	<a href="#">Samples</a>
LM339PWLE	OBSOLETE	TSSOP	PW	14		TBD	Call TI	Call TI	0 to 70		
LM339PWR	ACTIVE	TSSOP	PW	14	2000	Green (RoHS & no Sb/Br)	CU NIPDAU   CU SN	Level-1-260C-UNLIM	0 to 70	L339	<a href="#">Samples</a>
LM339PWRE4	ACTIVE	TSSOP	PW	14	2000	Green (RoHS & no Sb/Br)	CU NIPDAU	Level-1-260C-UNLIM	0 to 70	L339	<a href="#">Samples</a>
LM339PWRG3	ACTIVE	TSSOP	PW	14	2000	Green (RoHS & no Sb/Br)	CU SN	Level-1-260C-UNLIM	0 to 70	L339	<a href="#">Samples</a>
LM339PWRG4	ACTIVE	TSSOP	PW	14	2000	Green (RoHS & no Sb/Br)	CU NIPDAU	Level-1-260C-UNLIM	0 to 70	L339	<a href="#">Samples</a>
LM339Y	OBSOLETE			0		TBD	Call TI	Call TI	0 to 70		
M38510/11201BCA	ACTIVE	CDIP	J	14	1	TBD	A42	N / A for Pkg Type	-55 to 125	JM38510 /11201BCA	<a href="#">Samples</a>

(1) The marketing status values are defined as follows:

**ACTIVE:** Product device recommended for new designs.

**LIFEBUY:** TI has announced that the device will be discontinued, and a lifetime-buy period is in effect.

**NRND:** Not recommended for new designs. Device is in production to support existing customers, but TI does not recommend using this part in a new design.

**PREVIEW:** Device has been announced but is not in production. Samples may or may not be available.

**OBSOLETE:** TI has discontinued the production of the device.

(2) Eco Plan - The planned eco-friendly classification: Pb-Free (RoHS), Pb-Free (RoHS Exempt), or Green (RoHS & no Sb/Br) - please check <http://www.ti.com/productcontent> for the latest availability information and additional product content details.

**TBD:** The Pb-Free/Green conversion plan has not been defined.

**Pb-Free (RoHS):** TI's terms "Lead-Free" or "Pb-Free" mean semiconductor products that are compatible with the current RoHS requirements for all 6 substances, including the requirement that lead not exceed 0.1% by weight in homogeneous materials. Where designed to be soldered at high temperatures, TI Pb-Free products are suitable for use in specified lead-free processes.

**Pb-Free (RoHS Exempt):** This component has a RoHS exemption for either 1) lead-based flip-chip solder bumps used between the die and package, or 2) lead-based die adhesive used between the die and leadframe. The component is otherwise considered Pb-Free (RoHS compatible) as defined above.

**Green (RoHS & no Sb/Br):** TI defines "Green" to mean Pb-Free (RoHS compatible), and free of Bromine (Br) and Antimony (Sb) based flame retardants (Br or Sb do not exceed 0.1% by weight in homogeneous material)

- 
- (3) MSL, Peak Temp. - The Moisture Sensitivity Level rating according to the JEDEC industry standard classifications, and peak solder temperature.
- (4) There may be additional marking, which relates to the logo, the lot trace code information, or the environmental category on the device.
- (5) Multiple Device Markings will be inside parentheses. Only one Device Marking contained in parentheses and separated by a "-" will appear on a device. If a line is indented then it is a continuation of the previous line and the two combined represent the entire Device Marking for that device.
- (6) Lead/Ball Finish - Orderable Devices may have multiple material finish options. Finish options are separated by a vertical ruled line. Lead/Ball Finish values may wrap to two lines if the finish value exceeds the maximum column width.

**Important Information and Disclaimer:**The information provided on this page represents TI's knowledge and belief as of the date that it is provided. TI bases its knowledge and belief on information provided by third parties, and makes no representation or warranty as to the accuracy of such information. Efforts are underway to better integrate information from third parties. TI has taken and continues to take reasonable steps to provide representative and accurate information but may not have conducted destructive testing or chemical analysis on incoming materials and chemicals. TI and TI suppliers consider certain information to be proprietary, and thus CAS numbers and other limited information may not be available for release.

In no event shall TI's liability arising out of such information exceed the total purchase price of the TI part(s) at issue in this document sold by TI to Customer on an annual basis.

**OTHER QUALIFIED VERSIONS OF LM139, LM139-SP, LM239A, LM2901, LM2901AV, LM2901V :**

- Catalog: [LM139](#)
- Automotive: [LM239A-Q1](#), [LM2901-Q1](#), [LM2901AV-Q1](#), [LM2901V-Q1](#)
- Enhanced Product: [LM239A-EP](#)
- Space: [LM139-SP](#)

**NOTE: Qualified Version Definitions:**

- Catalog - TI's standard catalog product
- Automotive - Q100 devices qualified for high-reliability automotive applications targeting zero defects
- Enhanced Product - Supports Defense, Aerospace and Medical Applications
- Space - Radiation tolerant, ceramic packaging and qualified for use in Space-based application

## TAPE AND REEL INFORMATION



### QUADRANT ASSIGNMENTS FOR PIN 1 ORIENTATION IN TAPE



\*All dimensions are nominal

Device	Package Type	Package Drawing	Pins	SPQ	Reel Diameter (mm)	Reel Width W1 (mm)	A0 (mm)	B0 (mm)	K0 (mm)	P1 (mm)	W (mm)	Pin1 Quadrant
LM139ADR	SOIC	D	14	2500	330.0	16.4	6.5	9.0	2.1	8.0	16.0	Q1
LM139DR	SOIC	D	14	2500	330.0	16.4	6.5	9.0	2.1	8.0	16.0	Q1
LM239ADR	SOIC	D	14	2500	330.0	16.4	6.5	9.0	2.1	8.0	16.0	Q1
LM239ADR	SOIC	D	14	2500	330.0	16.4	6.5	9.0	2.1	8.0	16.0	Q1
LM239DR	SOIC	D	14	2500	330.0	16.4	6.5	9.0	2.1	8.0	16.0	Q1
LM239DR	SOIC	D	14	2500	330.0	16.4	6.5	9.0	2.1	8.0	16.0	Q1
LM239DR	SOIC	D	14	2500	330.0	16.8	6.5	9.5	2.3	8.0	16.0	Q1
LM239DRG3	SOIC	D	14	2500	330.0	16.8	6.5	9.5	2.3	8.0	16.0	Q1
LM239DRG4	SOIC	D	14	2500	330.0	16.4	6.5	9.0	2.1	8.0	16.0	Q1
LM239PWR	TSSOP	PW	14	2000	330.0	12.4	6.9	5.6	1.6	8.0	12.0	Q1
LM2901AVQPWR	TSSOP	PW	14	2000	330.0	12.4	6.9	5.6	1.6	8.0	12.0	Q1
LM2901AVQPWRG4	TSSOP	PW	14	2000	330.0	12.4	6.9	5.6	1.6	8.0	12.0	Q1
LM2901DR	SOIC	D	14	2500	330.0	16.4	6.5	9.0	2.1	8.0	16.0	Q1
LM2901DR	SOIC	D	14	2500	330.0	16.4	6.5	9.0	2.1	8.0	16.0	Q1
LM2901DR	SOIC	D	14	2500	330.0	16.8	6.5	9.5	2.3	8.0	16.0	Q1
LM2901DRG3	SOIC	D	14	2500	330.0	16.8	6.5	9.5	2.3	8.0	16.0	Q1
LM2901DRG4	SOIC	D	14	2500	330.0	16.4	6.5	9.0	2.1	8.0	16.0	Q1
LM2901NSR	SO	NS	14	2000	330.0	16.4	8.2	10.5	2.5	12.0	16.0	Q1

Device	Package Type	Package Drawing	Pins	SPQ	Reel Diameter (mm)	Reel Width W1 (mm)	A0 (mm)	B0 (mm)	K0 (mm)	P1 (mm)	W (mm)	Pin1 Quadrant
LM2901PWR	TSSOP	PW	14	2000	330.0	12.4	6.9	5.6	1.6	8.0	12.0	Q1
LM2901PWR	TSSOP	PW	14	2000	330.0	12.4	6.9	5.6	1.6	8.0	12.0	Q1
LM2901PWRG3	TSSOP	PW	14	2000	330.0	12.4	6.9	5.6	1.6	8.0	12.0	Q1
LM2901PWRG4	TSSOP	PW	14	2000	330.0	12.4	6.9	5.6	1.6	8.0	12.0	Q1
LM2901VQPWR	TSSOP	PW	14	2000	330.0	12.4	6.9	5.6	1.6	8.0	12.0	Q1
LM2901VQPWRG4	TSSOP	PW	14	2000	330.0	12.4	6.9	5.6	1.6	8.0	12.0	Q1
LM339ADB	SSOP	DB	14	2000	330.0	16.4	8.2	6.6	2.5	12.0	16.0	Q1
LM339ADR	SOIC	D	14	2500	330.0	16.4	6.5	9.0	2.1	8.0	16.0	Q1
LM339ADR	SOIC	D	14	2500	330.0	16.8	6.5	9.5	2.3	8.0	16.0	Q1
LM339ADR	SOIC	D	14	2500	330.0	16.4	6.5	9.0	2.1	8.0	16.0	Q1
LM339ADRG4	SOIC	D	14	2500	330.0	16.4	6.5	9.0	2.1	8.0	16.0	Q1
LM339ANSR	SO	NS	14	2000	330.0	16.4	8.2	10.5	2.5	12.0	16.0	Q1
LM339APWR	TSSOP	PW	14	2000	330.0	12.4	6.9	5.6	1.6	8.0	12.0	Q1
LM339DR	SOIC	D	14	2500	330.0	16.4	6.5	9.0	2.1	8.0	16.0	Q1
LM339DR	SOIC	D	14	2500	330.0	16.8	6.5	9.5	2.3	8.0	16.0	Q1
LM339DR	SOIC	D	14	2500	330.0	16.4	6.5	9.0	2.1	8.0	16.0	Q1
LM339DRG3	SOIC	D	14	2500	330.0	16.8	6.5	9.5	2.3	8.0	16.0	Q1
LM339DRG4	SOIC	D	14	2500	330.0	16.4	6.5	9.0	2.1	8.0	16.0	Q1
LM339PWR	TSSOP	PW	14	2000	330.0	12.4	6.9	5.6	1.6	8.0	12.0	Q1
LM339PWR	TSSOP	PW	14	2000	330.0	12.4	6.9	5.6	1.6	8.0	12.0	Q1
LM339PWRG3	TSSOP	PW	14	2000	330.0	12.4	6.9	5.6	1.6	8.0	12.0	Q1
LM339PWRG4	TSSOP	PW	14	2000	330.0	12.4	6.9	5.6	1.6	8.0	12.0	Q1

**TAPE AND REEL BOX DIMENSIONS**

\*All dimensions are nominal

Device	Package Type	Package Drawing	Pins	SPQ	Length (mm)	Width (mm)	Height (mm)
LM139ADR	SOIC	D	14	2500	367.0	367.0	38.0
LM139DR	SOIC	D	14	2500	367.0	367.0	38.0
LM239ADR	SOIC	D	14	2500	367.0	367.0	38.0
LM239ADR	SOIC	D	14	2500	333.2	345.9	28.6
LM239DR	SOIC	D	14	2500	367.0	367.0	38.0
LM239DR	SOIC	D	14	2500	333.2	345.9	28.6
LM239DR	SOIC	D	14	2500	364.0	364.0	27.0
LM239DRG3	SOIC	D	14	2500	364.0	364.0	27.0
LM239DRG4	SOIC	D	14	2500	333.2	345.9	28.6
LM239PWR	TSSOP	PW	14	2000	367.0	367.0	35.0
LM2901AVQPWR	TSSOP	PW	14	2000	367.0	367.0	35.0
LM2901AVQPWRG4	TSSOP	PW	14	2000	367.0	367.0	35.0
LM2901DR	SOIC	D	14	2500	333.2	345.9	28.6
LM2901DR	SOIC	D	14	2500	367.0	367.0	38.0
LM2901DR	SOIC	D	14	2500	364.0	364.0	27.0
LM2901DRG3	SOIC	D	14	2500	364.0	364.0	27.0
LM2901DRG4	SOIC	D	14	2500	333.2	345.9	28.6
LM2901NSR	SO	NS	14	2000	367.0	367.0	38.0
LM2901PWR	TSSOP	PW	14	2000	364.0	364.0	27.0
LM2901PWR	TSSOP	PW	14	2000	367.0	367.0	35.0

Device	Package Type	Package Drawing	Pins	SPQ	Length (mm)	Width (mm)	Height (mm)
LM2901PWRG3	TSSOP	PW	14	2000	364.0	364.0	27.0
LM2901PWRG4	TSSOP	PW	14	2000	367.0	367.0	35.0
LM2901VQPWR	TSSOP	PW	14	2000	367.0	367.0	35.0
LM2901VQPWRG4	TSSOP	PW	14	2000	367.0	367.0	35.0
LM339ADBR	SSOP	DB	14	2000	367.0	367.0	38.0
LM339ADR	SOIC	D	14	2500	333.2	345.9	28.6
LM339ADR	SOIC	D	14	2500	364.0	364.0	27.0
LM339ADR	SOIC	D	14	2500	367.0	367.0	38.0
LM339ADRG4	SOIC	D	14	2500	333.2	345.9	28.6
LM339ANSR	SO	NS	14	2000	367.0	367.0	38.0
LM339APWR	TSSOP	PW	14	2000	367.0	367.0	35.0
LM339DR	SOIC	D	14	2500	367.0	367.0	38.0
LM339DR	SOIC	D	14	2500	364.0	364.0	27.0
LM339DR	SOIC	D	14	2500	333.2	345.9	28.6
LM339DRG3	SOIC	D	14	2500	364.0	364.0	27.0
LM339DRG4	SOIC	D	14	2500	333.2	345.9	28.6
LM339PWR	TSSOP	PW	14	2000	367.0	367.0	35.0
LM339PWR	TSSOP	PW	14	2000	364.0	364.0	27.0
LM339PWRG3	TSSOP	PW	14	2000	364.0	364.0	27.0
LM339PWRG4	TSSOP	PW	14	2000	367.0	367.0	35.0

J (R-GDIP-T\*\*)

14 LEADS SHOWN

CERAMIC DUAL IN-LINE PACKAGE



DIM \ PINS **	14	16	18	20
A	0.300 (7,62) BSC	0.300 (7,62) BSC	0.300 (7,62) BSC	0.300 (7,62) BSC
B MAX	0.785 (19,94)	.840 (21,34)	0.960 (24,38)	1.060 (26,92)
B MIN	—	—	—	—
C MAX	0.300 (7,62)	0.300 (7,62)	0.310 (7,87)	0.300 (7,62)
C MIN	0.245 (6,22)	0.245 (6,22)	0.220 (5,59)	0.245 (6,22)



4040083/F 03/03

- NOTES:
- All linear dimensions are in inches (millimeters).
  - This drawing is subject to change without notice.
  - This package is hermetically sealed with a ceramic lid using glass frit.
  - Index point is provided on cap for terminal identification only on press ceramic glass frit seal only.
  - Falls within MIL STD 1835 GDIP1-T14, GDIP1-T16, GDIP1-T18 and GDIP1-T20.

W (R-GDFP-F14)

CERAMIC DUAL FLATPACK



- NOTES:
- A. All linear dimensions are in inches (millimeters).
  - B. This drawing is subject to change without notice.
  - C. This package can be hermetically sealed with a ceramic lid using glass frit.
  - D. Index point is provided on cap for terminal identification only.
  - E. Falls within MIL STD 1835 GDFP1-F14



FK (S-CQCC-N\*\*)

LEADLESS CERAMIC CHIP CARRIER

28 TERMINAL SHOWN



NO. OF TERMINALS **	A		B	
	MIN	MAX	MIN	MAX
20	0.342 (8,69)	0.358 (9,09)	0.307 (7,80)	0.358 (9,09)
28	0.442 (11,23)	0.458 (11,63)	0.406 (10,31)	0.458 (11,63)
44	0.640 (16,26)	0.660 (16,76)	0.495 (12,58)	0.560 (14,22)
52	0.740 (18,78)	0.761 (19,32)	0.495 (12,58)	0.560 (14,22)
68	0.938 (23,83)	0.962 (24,43)	0.850 (21,6)	0.858 (21,8)
84	1.141 (28,99)	1.165 (29,59)	1.047 (26,6)	1.063 (27,0)



4040140/D 01/11

- NOTES:
- All linear dimensions are in inches (millimeters).
  - This drawing is subject to change without notice.
  - This package can be hermetically sealed with a metal lid.
  - Falls within JEDEC MS-004

N (R-PDIP-T\*\*)

PLASTIC DUAL-IN-LINE PACKAGE

16 PINS SHOWN



- NOTES:
- A. All linear dimensions are in inches (millimeters).
  - B. This drawing is subject to change without notice.
  - Falls within JEDEC MS-001, except 18 and 20 pin minimum body length (Dim A).
  - The 20 pin end lead shoulder width is a vendor option, either half or full width.

D (R-PDSO-G14)

PLASTIC SMALL OUTLINE



- NOTES:
- A. All linear dimensions are in inches (millimeters).
  - B. This drawing is subject to change without notice.
  - $\triangle$  Body length does not include mold flash, protrusions, or gate burrs. Mold flash, protrusions, or gate burrs shall not exceed 0.006 (0,15) each side.
  - $\diamond$  Body width does not include interlead flash. Interlead flash shall not exceed 0.017 (0,43) each side.
  - E. Reference JEDEC MS-012 variation AB.

D (R-PDSO-G14)

PLASTIC SMALL OUTLINE



4211283-3/E 08/12

- NOTES:
- All linear dimensions are in millimeters.
  - This drawing is subject to change without notice.
  - Publication IPC-7351 is recommended for alternate designs.
  - Laser cutting apertures with trapezoidal walls and also rounding corners will offer better paste release. Customers should contact their board assembly site for stencil design recommendations. Refer to IPC-7525 for other stencil recommendations.
  - Customers should contact their board fabrication site for solder mask tolerances between and around signal pads.



PW (R-PDSO-G14)

PLASTIC SMALL OUTLINE



- NOTES:
- All linear dimensions are in millimeters.
  - This drawing is subject to change without notice.
  - Publication IPC-7351 is recommended for alternate designs.
  - Laser cutting apertures with trapezoidal walls and also rounding corners will offer better paste release. Customers should contact their board assembly site for stencil design recommendations. Refer to IPC-7525 for other stencil recommendations.
  - Customers should contact their board fabrication site for solder mask tolerances between and around signal pads.

# MECHANICAL DATA

NS (R-PDSO-G\*\*)

PLASTIC SMALL-OUTLINE PACKAGE

14-PINS SHOWN



- NOTES:
- A. All linear dimensions are in millimeters.
  - B. This drawing is subject to change without notice.
  - C. Body dimensions do not include mold flash or protrusion, not to exceed 0,15.

DB (R-PDSO-G\*\*)

PLASTIC SMALL-OUTLINE

28 PINS SHOWN



- NOTES: A. All linear dimensions are in millimeters.  
 B. This drawing is subject to change without notice.  
 C. Body dimensions do not include mold flash or protrusion not to exceed 0,15.  
 D. Falls within JEDEC MO-150



## IMPORTANT NOTICE

Texas Instruments Incorporated and its subsidiaries (TI) reserve the right to make corrections, enhancements, improvements and other changes to its semiconductor products and services per JESD46, latest issue, and to discontinue any product or service per JESD48, latest issue. Buyers should obtain the latest relevant information before placing orders and should verify that such information is current and complete. All semiconductor products (also referred to herein as "components") are sold subject to TI's terms and conditions of sale supplied at the time of order acknowledgment.

TI warrants performance of its components to the specifications applicable at the time of sale, in accordance with the warranty in TI's terms and conditions of sale of semiconductor products. Testing and other quality control techniques are used to the extent TI deems necessary to support this warranty. Except where mandated by applicable law, testing of all parameters of each component is not necessarily performed.

TI assumes no liability for applications assistance or the design of Buyers' products. Buyers are responsible for their products and applications using TI components. To minimize the risks associated with Buyers' products and applications, Buyers should provide adequate design and operating safeguards.

TI does not warrant or represent that any license, either express or implied, is granted under any patent right, copyright, mask work right, or other intellectual property right relating to any combination, machine, or process in which TI components or services are used. Information published by TI regarding third-party products or services does not constitute a license to use such products or services or a warranty or endorsement thereof. Use of such information may require a license from a third party under the patents or other intellectual property of the third party, or a license from TI under the patents or other intellectual property of TI.

Reproduction of significant portions of TI information in TI data books or data sheets is permissible only if reproduction is without alteration and is accompanied by all associated warranties, conditions, limitations, and notices. TI is not responsible or liable for such altered documentation. Information of third parties may be subject to additional restrictions.

Resale of TI components or services with statements different from or beyond the parameters stated by TI for that component or service voids all express and any implied warranties for the associated TI component or service and is an unfair and deceptive business practice. TI is not responsible or liable for any such statements.

Buyer acknowledges and agrees that it is solely responsible for compliance with all legal, regulatory and safety-related requirements concerning its products, and any use of TI components in its applications, notwithstanding any applications-related information or support that may be provided by TI. Buyer represents and agrees that it has all the necessary expertise to create and implement safeguards which anticipate dangerous consequences of failures, monitor failures and their consequences, lessen the likelihood of failures that might cause harm and take appropriate remedial actions. Buyer will fully indemnify TI and its representatives against any damages arising out of the use of any TI components in safety-critical applications.

In some cases, TI components may be promoted specifically to facilitate safety-related applications. With such components, TI's goal is to help enable customers to design and create their own end-product solutions that meet applicable functional safety standards and requirements. Nonetheless, such components are subject to these terms.

No TI components are authorized for use in FDA Class III (or similar life-critical medical equipment) unless authorized officers of the parties have executed a special agreement specifically governing such use.

Only those TI components which TI has specifically designated as military grade or "enhanced plastic" are designed and intended for use in military/aerospace applications or environments. Buyer acknowledges and agrees that any military or aerospace use of TI components which have **not** been so designated is solely at the Buyer's risk, and that Buyer is solely responsible for compliance with all legal and regulatory requirements in connection with such use.

TI has specifically designated certain components as meeting ISO/TS16949 requirements, mainly for automotive use. In any case of use of non-designated products, TI will not be responsible for any failure to meet ISO/TS16949.

### Products

Audio	<a href="http://www.ti.com/audio">www.ti.com/audio</a>
Amplifiers	<a href="http://amplifier.ti.com">amplifier.ti.com</a>
Data Converters	<a href="http://dataconverter.ti.com">dataconverter.ti.com</a>
DLP® Products	<a href="http://www.dlp.com">www.dlp.com</a>
DSP	<a href="http://dsp.ti.com">dsp.ti.com</a>
Clocks and Timers	<a href="http://www.ti.com/clocks">www.ti.com/clocks</a>
Interface	<a href="http://interface.ti.com">interface.ti.com</a>
Logic	<a href="http://logic.ti.com">logic.ti.com</a>
Power Mgmt	<a href="http://power.ti.com">power.ti.com</a>
Microcontrollers	<a href="http://microcontroller.ti.com">microcontroller.ti.com</a>
RFID	<a href="http://www.ti-rfid.com">www.ti-rfid.com</a>
OMAP Applications Processors	<a href="http://www.ti.com/omap">www.ti.com/omap</a>
Wireless Connectivity	<a href="http://www.ti.com/wirelessconnectivity">www.ti.com/wirelessconnectivity</a>

### Applications

Automotive and Transportation	<a href="http://www.ti.com/automotive">www.ti.com/automotive</a>
Communications and Telecom	<a href="http://www.ti.com/communications">www.ti.com/communications</a>
Computers and Peripherals	<a href="http://www.ti.com/computers">www.ti.com/computers</a>
Consumer Electronics	<a href="http://www.ti.com/consumer-apps">www.ti.com/consumer-apps</a>
Energy and Lighting	<a href="http://www.ti.com/energy">www.ti.com/energy</a>
Industrial	<a href="http://www.ti.com/industrial">www.ti.com/industrial</a>
Medical	<a href="http://www.ti.com/medical">www.ti.com/medical</a>
Security	<a href="http://www.ti.com/security">www.ti.com/security</a>
Space, Avionics and Defense	<a href="http://www.ti.com/space-avionics-defense">www.ti.com/space-avionics-defense</a>
Video and Imaging	<a href="http://www.ti.com/video">www.ti.com/video</a>

### TI E2E Community

[e2e.ti.com](http://e2e.ti.com)