

TO-252-2L Plastic-Encapsulate Transistors

2SB1184 TRANSISTOR (PNP)

FEATURES

- Low $V_{CE(sat)}$. $V_{CE(sat)} = -0.5V$ (Typ.) ($I_C/I_B = -2A / -0.2A$)
- Complements the 2SD1760 / 2SD1864.

MAXIMUM RATINGS ($T_a=25^\circ C$ unless otherwise noted)

| Symbol | Parameter | Value | Unit |
|-----------|-------------------------------|---------|------------|
| V_{CBO} | Collector Base Voltage | -60 | V |
| V_{CEO} | Collector-Emitter Voltage | -50 | V |
| V_{EBO} | Emitter-Base Voltage | -5 | V |
| I_C | Collector Current –Continuous | -3 | A |
| P_C | Collector Power Dissipation | 1 | W |
| T_J | Junction Temperature | 150 | $^\circ C$ |
| T_{stg} | Storage Temperature | -55-150 | $^\circ C$ |

TO-252-2L

1. BASE
2. COLLECTOR
3. EMITTER

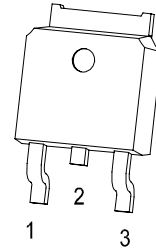

ELECTRICAL CHARACTERISTICS ($T_a=25^\circ C$ unless otherwise specified)

| Parameter | Symbol | Test conditions | Min | Typ | Max | Unit |
|--------------------------------------|---------------|--|-----|-----|------|---------|
| Collector-base breakdown voltage | $V_{(BR)CBO}$ | $I_C = -50\mu A, I_E = 0$ | -60 | | | V |
| Collector-emitter breakdown voltage | $V_{(BR)CEO}$ | $I_C = -1mA, I_B = 0$ | -50 | | | V |
| Emitter-base breakdown voltage | $V_{(BR)EBO}$ | $I_E = -50\mu A, I_C = 0$ | -5 | | | V |
| Collector cut-off current | I_{CBO} | $V_{CB} = -40V, I_E = 0$ | | | -1 | μA |
| Emitter cut-off current | I_{EBO} | $V_{EB} = -4V, I_C = 0$ | | | -1 | μA |
| DC current gain | $h_{FE(1)}$ | $V_{CE} = -3V, I_C = -0.5A$ | 82 | | 390 | |
| Collector-emitter saturation voltage | $V_{CE(sat)}$ | $I_C = -2A, I_B = -0.2A$ | | | -1 | V |
| Base-emitter saturation voltage | $V_{BE(sat)}$ | $I_C = -1.5A, I_B = -0.15A$ | | | -1.2 | V |
| Transition frequency | f_T | $V_{CE} = -5V, I_C = -0.5A, f = 30MHz$ | | 70 | | MHz |
| Collector output capacitance | C_{ob} | $V_{CB} = -10V, I_E = 0, f = 1MHz$ | | 50 | | pF |

CLASSIFICATION OF $h_{FE(1)}$

| Rank | P | Q | R |
|---------|--------|---------|---------|
| Range | 82-180 | 120-270 | 180-390 |
| Marking | | | |

Typical Characteristics

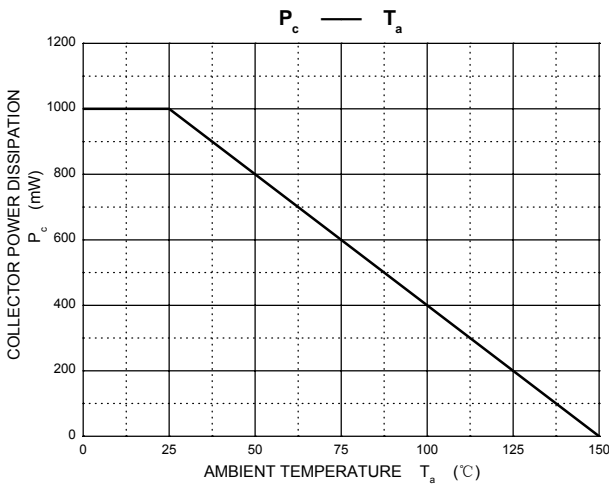
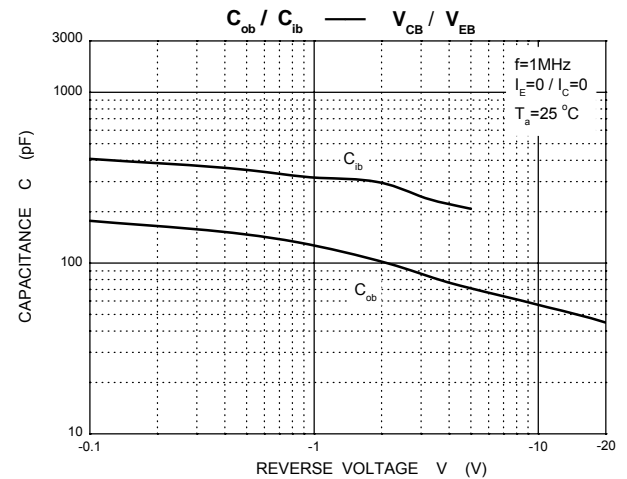
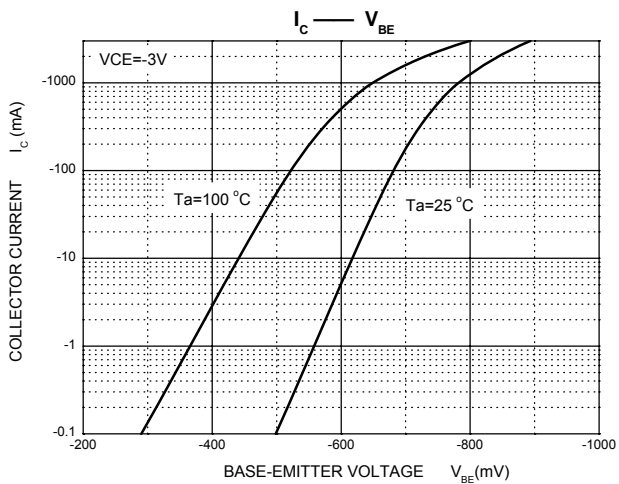
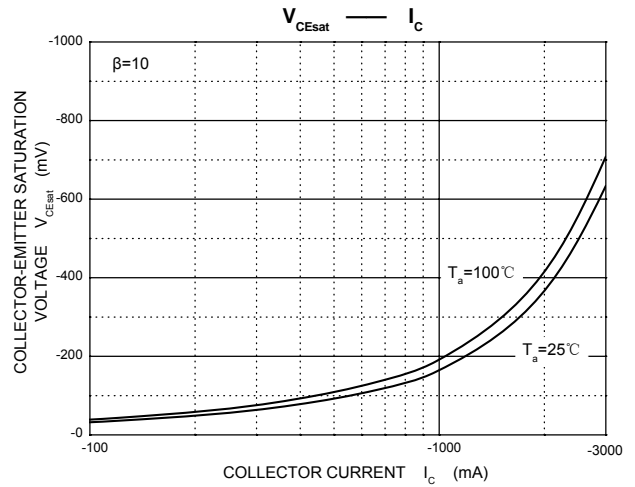
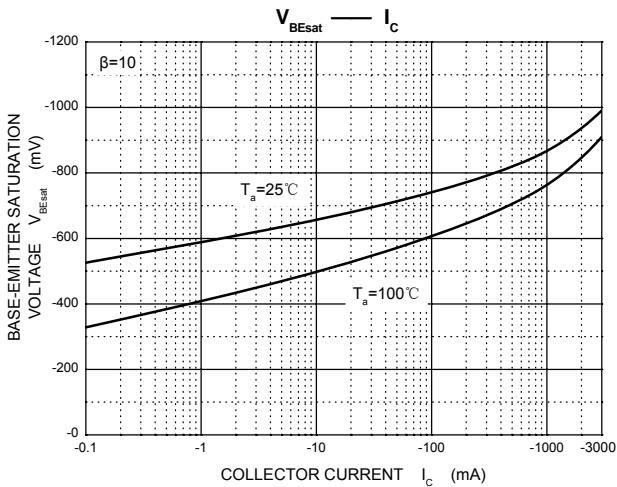
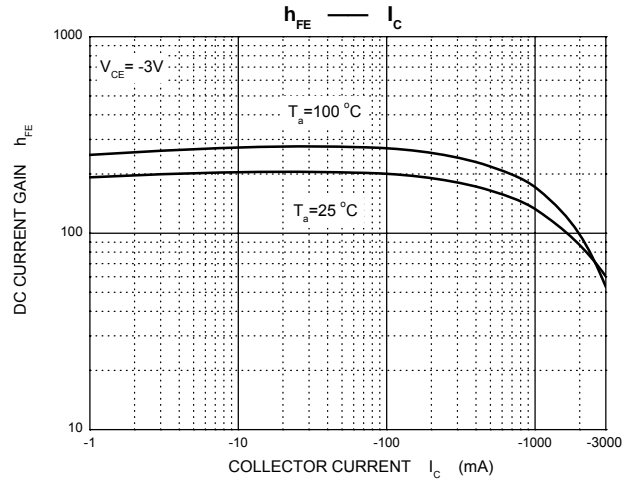
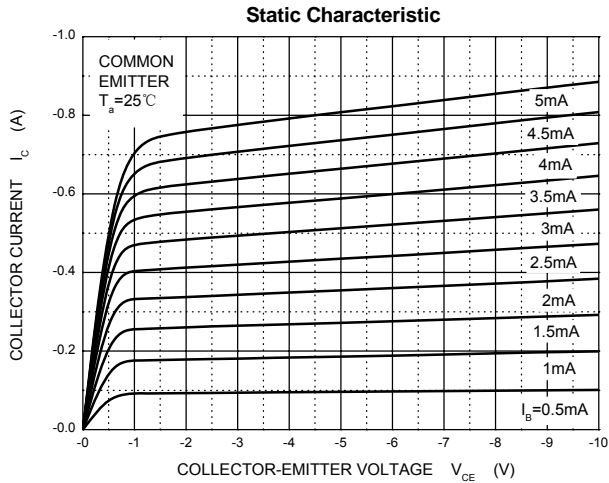

TO-252(4R)-2L Package Outline Dimensions

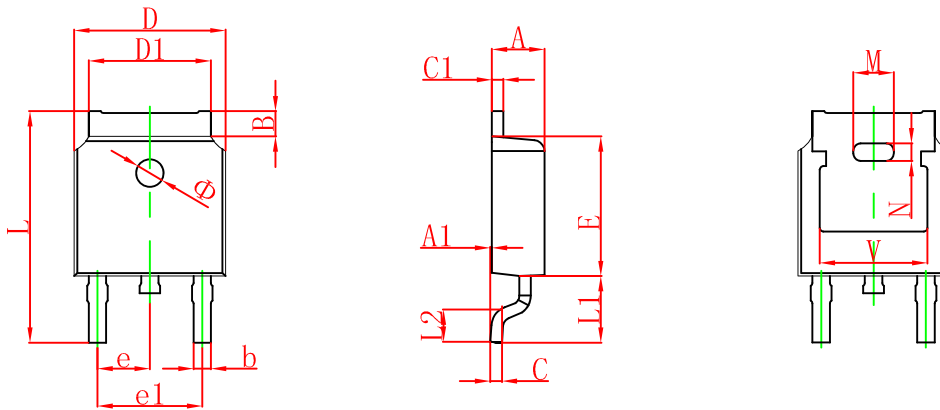

| Symbol | Dimensions In Millimeters | | Dimensions In Inches | |
|--------|---------------------------|--------|----------------------|-------|
| | Min. | Max. | Min. | Max. |
| A | 2.200 | 2.380 | 0.087 | 0.094 |
| A1 | 0.000 | 0.100 | 0.000 | 0.004 |
| B | 0.800 | 1.400 | 0.031 | 0.055 |
| b | 0.710 | 0.810 | 0.028 | 0.032 |
| c | 0.460 | 0.560 | 0.018 | 0.022 |
| c1 | 0.460 | 0.560 | 0.018 | 0.022 |
| D | 6.500 | 6.700 | 0.256 | 0.264 |
| D1 | 5.130 | 5.460 | 0.202 | 0.215 |
| E | 6.000 | 6.200 | 0.236 | 0.244 |
| e | 2.286 TYP. | | 0.090 TYP. | |
| e1 | 4.327 | 4.727 | 0.170 | 0.186 |
| M | 1.778REF. | | 0.070REF. | |
| N | 0.762REF. | | 0.018REF. | |
| L | 9.800 | 10.400 | 0.386 | 0.409 |
| L1 | 2.9REF. | | 0.114REF. | |
| L2 | 1.400 | 1.700 | 0.055 | 0.067 |
| V | 4.830 REF. | | 0.190 REF. | |
| Φ | 1.100 | 1.300 | 0.043 | 0.051 |

TO-252(4R)-2L Suggested Pad Layout

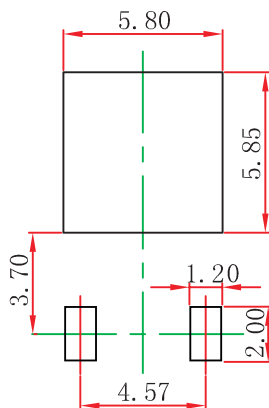

Note:

1. Controlling dimension: in millimeters.
2. General tolerance: ± 0.05 mm.
3. The pad layout is for reference purposes only.

NOTICE

JCET reserve the right to make modifications, enhancements, improvements, corrections or other changes without further notice to any product herein. JCET does not assume any liability arising out of the application or use of any product described herein.

TO-252 Tape and reel

TO-252 Embossed Carrier Tape

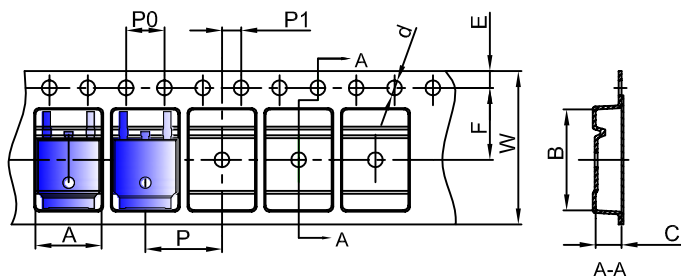

Packaging Description:

TO-252 parts are shipped in tape. The carrier tape is made from a dissipative (carbon filled) polycarbonate resin. The cover tape is a multilayer film (Heat Activated Adhesive in nature) primarily composed of polyester film, adhesive layer, sealant, and anti-static sprayed agent. These reeled parts in standard option are shipped with 25,00 units per 13" or 33.0 cm diameter reel. The reels are clear in color and is made of polystyrene plastic (anti-static coated).

| Dimensions are in millimeter | | | | | | | | | | |
|------------------------------|--------|--------|--------|--------|--------|--------|--------|--------|--------|-----------|
| Pkg type | A | B | C | d | E | F | P0 | P | P1 | W |
| TO-252 | 6.90 | 10.50 | 2.70 | Ø1.55 | 1.75 | 7.50 | 4.00 | 8.00 | 2.00 | 16.00 |
| (Tolerance) | +/-0.1 | +/-0.1 | +/-0.1 | +/-0.1 | +/-0.1 | +/-0.1 | +/-0.1 | +/-0.1 | +/-0.1 | +0.3/-0.1 |

TO-252 Tape Leader and Trailer

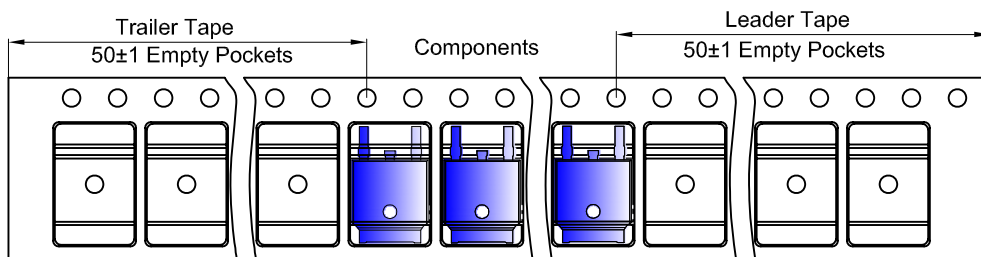

TO-252 Reel

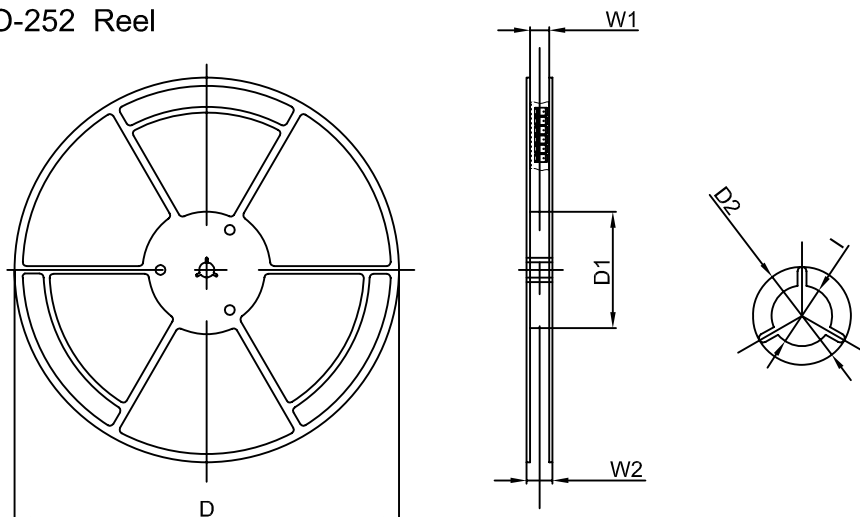

| Dimensions are in millimeter | | | | | | |
|------------------------------|--------|--------|--------|-------|-------|--------|
| Reel Option | D | D1 | D2 | W1 | W2 | I |
| 13"Dia | 330.00 | 100.00 | Ø21.00 | 16.40 | 21.00 | Ø13.00 |
| Tolerance | +/-2 | +/-1 | +/-1 | +/-1 | +/-1 | +/-1 |

| REEL | Reel Size | Box | Box Size(mm) | Carton | Carton Size(mm) | G.W.(kg) |
|-----------|-----------|-----------|--------------|------------|-----------------|----------|
| 2,500 pcs | 13inch | 2,500 pcs | 340×336×29 | 25,000 pcs | 353×346×365 | 14.04 |