



# **AU6438-JBS**

**USB2.0 Single-LUN Flash Card  
Reader Controller**

**Technical Reference Manual**

**Rev. 1.00**

**Jul. 2010**



# **AU6438-JBS**

**USB2.0 Single-LUN Flash Card  
Reader Controller**

**Rev. 1.00  
Jul. 2010**



## Copyright

Copyright © 1997 – 2010. Alcor Micro, Corp. All Rights Reserved. No part of this data sheet may be reproduced, transmitted, transcribed, stored in a retrieval system or translated into any language or computer language, in any form or by any means, electronic, mechanical, magnetic, optical, chemical, manual or otherwise, without prior written permission from Alcor Micro, Corp.

## Trademark Acknowledgements

The company and product names mentioned in this document may be the trademarks or registered trademarks of their manufacturers.

## Disclaimer

Alcor Micro, Corp. reserves the right to change this product without prior notice. Alcor Micro, Corp. makes no warranty for the use of its products and bears no responsibility for any errors that appear in this document. Specifications are subject to change without prior notice.

## Revision History

Date	Revision	Description
Sep 2009	0.90	Preliminary Release
Feb 2010	0.91	Update "1.1 Description and 1.2 Features"
Mar 2010	0.92	Update "Figure 4.1 AU6438 Block Diagram and 1.2 Features "
Jul 2010	1.00	Modify "5. Electrical Characteristics"

## Contact Information:

Web site: <http://www.alcormicro.com/>

### Taiwan

Alcor Micro, Corp.  
9F., No.66, Sanchong Rd.,  
Nangang District, Taipei 115,  
Taiwan, R.O.C.  
Phone: 886-2-2653-5000  
Fax: 886-2-2786-8567

### China ShenZhen Office

Rm.2407-08, Industrial Bank Building  
No.4013, Shennan Road,  
ShenZhen,China. 518026  
Phone: (0755) 8366-9039  
Fax: (0755) 8366-9101

### San Jose Office

2025 Gateway Place, Suite 335  
San Jose, CA 95110  
USA  
Phone: (408) 453-9530  
Fax: (408) 453-9523

### Los Angeles Office

8351 Elm Ave, Suite 103  
Rancho Cucamonga, CA 91730  
USA  
Phone: (909) 483-8821  
Fax: (909) 944-0464



AU6438-JBS USB2.0 Single-LUN Flash Card Reader V1.00

Alcor Micro, Corp.

[www.alcormicro.com](http://www.alcormicro.com)

**<Memo>**



# Table of Contents

<b>1. Introduction .....</b>	<b>1</b>
1.1 Description.....	1
1.2 Features.....	1
<b>2. Application Block Diagram .....</b>	<b>3</b>
<b>3. Pin Assignment .....</b>	<b>4</b>
<b>4. System Architecture and Reference Design .....</b>	<b>6</b>
4.1 AU6438 Block Diagram .....	6
<b>5. Electrical Characteristics .....</b>	<b>7</b>
5.1 Absolute Maximum Ratings.....	7
5.2 Recommended Operating Conditions .....	7
5.3 General DC Characteristics .....	7
5.4 DC Electrical Characteristics of 3.3V I/O Cells.....	8
5.5 USB Transceiver Characteristics .....	8
5.6 Power Switch Feature .....	11
5.7 Chip Reset Timing .....	12
<b>6. Mechanical Information .....</b>	<b>13</b>
<b>7. Abbreviations .....</b>	<b>14</b>



## List of Figures

Figure 2.1 Block Diagram .....	3
Figure 3.1 AU6438 Pin Assignment Diagram.....	4
Figure 4.1 AU6438 Block Diagram.....	6
Figure 5.1 Card Power Switch Output Capacity .....	11
Figure 5.2 Card Detect Power-in Timing .....	11
Figure 5.3 Chip Reset Timing.....	12
Figure 6.1 Mechanical Information Diagram.....	13

## List of Tables

Table 3.1 AU6438 Pin Descriptions .....	5
Table 5.1 Absolute Maximum Ratings.....	7
Table 5.2 Recommended Operating Conditions .....	7
Table 5.3 General DC Characteristics .....	7
Table 5.4 DC Electrical Characteristics of 3.3V I/O Cells.....	8
Table 5.5 Electrical characteristics .....	8
Table 5.6 Static characteristic : Digital pin.....	9
Table 5.7 Static characteristic : Analog I/O pins ( DP/DM ) .....	9
Table 5.8 Dynamic characteristic : Analog I/O pins ( DP/DM ) .....	10



# 1. Introduction

## 1.1 Description

The AU6438 is designed to deliver outstanding performance for data transmission between USB and compatible flash card interface. It supports USB 2.0 high-speed transferring to various types of flash media cards such as SD, MMC and MS. Besides, the AU6438 supports several operating systems, including MS Windows, LINUX and Mac OS.

The design of 2-in-1 combo single slot makes the AU6438 more attractive and optimal. The AU6438 integrates a high performance 8051 CPU as well as a splendidly efficient DMA hardware engine and internal 5V to 3.3V/3.3V to 1.8V regulators. The AU6438 provides manufacturers not merely BOM cost saving with the minimal numbers of components needed on the PCB but also smaller circuit board with the 28-pin SSOP (150mil) package.

In addition to high-speed 8051 CPU embedded and DMA hardware engine integrated, the AU6438 is fully compliant with USB Device Class Definition for Mass Storage and Bulk-Transport V1.0. Combination with these features, the AU6438 provides a completely ultra high performance USB2.0 card reader solution in a single chip.

AU6438 maximizes performance with the latest and fastest flash card specification available from the industry. Based on the features of low pin count and high performance characteristic, AU6438 supports a wide range of flash card reader applications used to digital camera, MP3 players, cell phone, PDA, camcorder, GPS device and so on to store many types of data, such as digital map, digital photos and compressed music.

## 1.2 Features

### ■General

- Fully compatible with USB2.0 High Speed and backward compatible with USB1.1 specifications
- Supports multiple flash card interfaces, including SD/MMC/MS.
- Supports single LUN
- Supports both Windows and Mac OS
  - Default Mass Storage Class driver comes from Windows ME/2000/XP/Vista/Windows 7 and Mac OS
  - Windows 98 is supported by vendor driver from Alcor
- 28-pin SSOP lead-free/Halogen-free/RoHS compliant package is available.

### ■Compliance

- Complies with USB Device Class Definition for Mass Storage and Bulk-Transport V1.0
- Complies with Secure Digital Card (SD) specification up to ver. 3.0(SDXC)
- Complies with MultiMedia Card (MMC) specification up to ver. 4.2
- Complies with Memory Stick (MS) specification up to ver. 1.43
- Complies with Memory Stick PRO (MS\_Pro) specification up to ver. 1.02
- Complies with Memory Stick PRO-HG (MS PRO-HG) specification up to ver. 1.01
- Complies with Memory Stick Interface Guideline for PC peripheral devices with Memory Stick Slot ver.1.16-00

### ■Benefit



- 1K bytes of ping-pong FIFO buffers the data transmission between transmitter and receiver
- Integrated hardware DMA engine enhances overall performance of data transfers
- Supports power saving mode to reduce power consumption
- User-friendly Dynamic icon utility software can display icon message upon insertion/removal of compatible flash cards under Windows
- Optimizes performance via multiple sectors transfer
- Built-in 5V to 3.3V/3.3V to 1.8V regulator offers customers lower BOM cost
- Clock runs at 48MHz crystal



## 2. Application Block Diagram

Following application diagram demonstrates a typical card reader using the AU6438 chip. By connecting the card reader to a desktop or notebook PC through USB bus, the AU6438 becomes a bus-powered, high speed USB card reader, which can be used as a bridge for data transfer between Desktop PC and Notebook PC.

Figure 2.1 Block Diagram

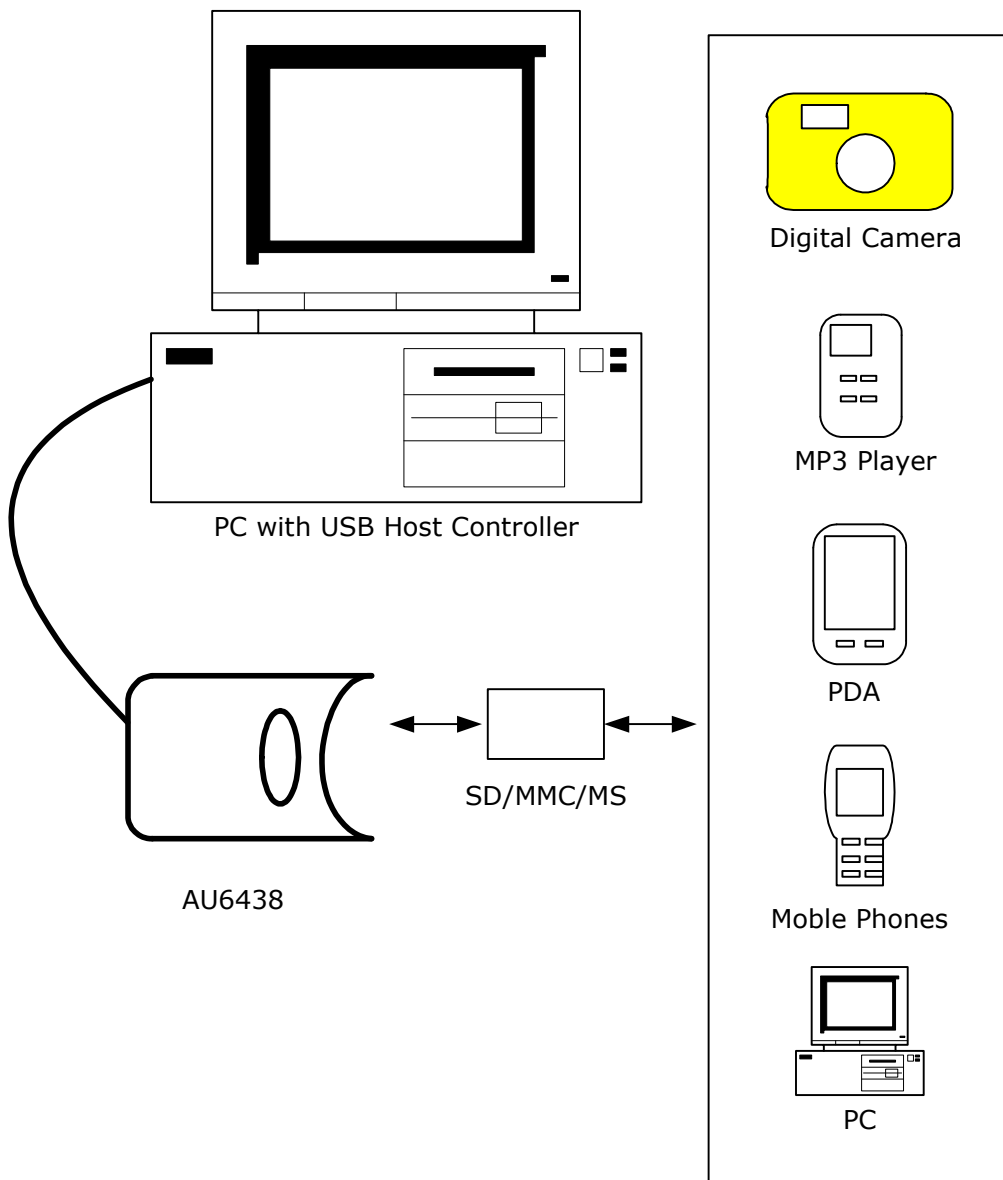



### 3. Pin Assignment

AU6438 is available in 28-pin SSOP package. Below diagram shows signal name of each pin and table in the following page describes each pin in detail.

Figure 3.1 AU6438 Pin Assignment Diagram

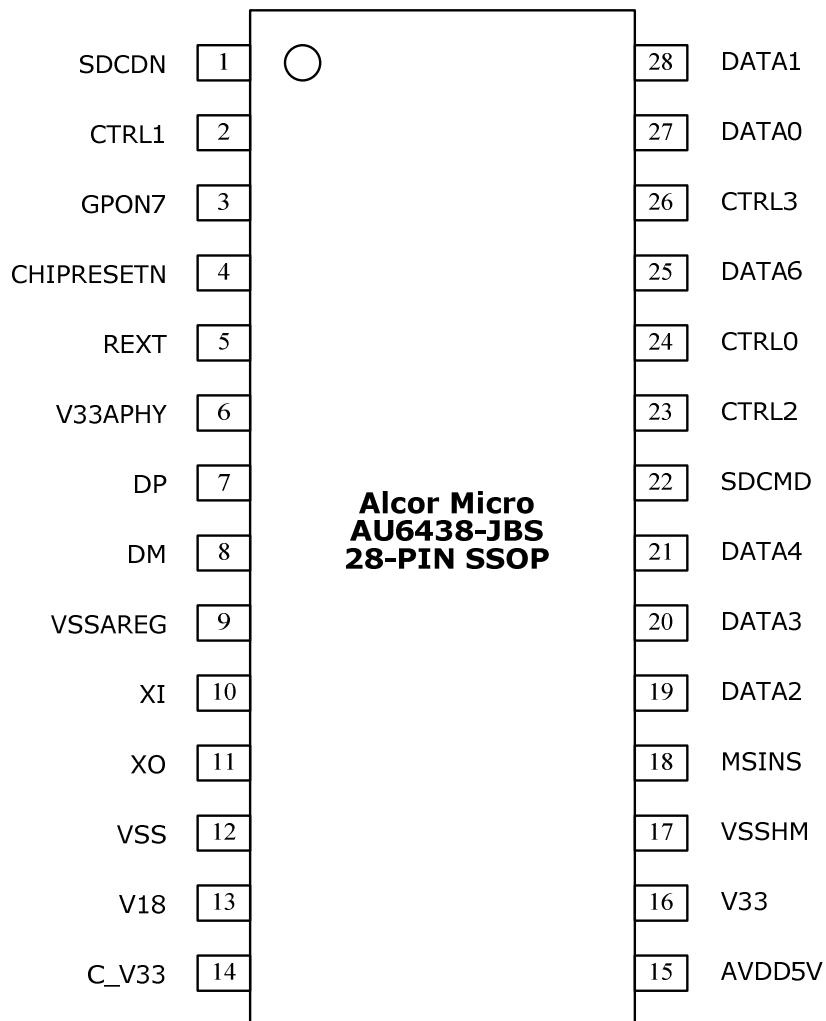



Table 3.1 AU6438 Pin Descriptions

Pin #	Pin Name	I/O	Description
1	SDCDN	IO	SDCDN
2	CTRL1	IO	SDWP/MSCLK
3	GPON7	O	Card access LED.
4	CHIPRESETN	I	Chip reset. Low active. Internal pull up.
5	REXT		680 $\Omega$ reference resistance
6	V33APHY		PHY 3.3V power pin
7	DP		USB DP
8	DM		USB DM
9	VSSAREG		
10	XI	I	Crystal input
11	XO	O	Crystal output
12	VSS		
13	V18		Regulator 1.8V output
14	C_V33		Card power 3.3V output
15	AVDD5V		Regulator 5V input
16	V33		Regulator 3.3V output
17	VSSHM		
18	MSINS	IO	MSINS
19	DATA2	IO	SDDATA2/MSDATA2
20	DATA3	IO	SDDATA3/MSDATA3
21	DATA4	IO	SDDATA4
22	SDCMD	IO	SDCMD
23	CTRL2	IO	SDDATA5/EEPCLK When I2C mode, internal has 45-75K pull up
24	CTRL0	IO	SDCLK/MSBS
25	DATA6	IO	SDDATA6
26	CTRL3	IO	SDDATA7/EEPDAT When I2C mode, internal has 45-75K pull up
27	DATA0	IO	SDDATA0/MSDATA0
28	DATA1	IO	SDDATA1/MSDATA1



# 4. System Architecture and Reference Design

## 4.1 AU6438 Block Diagram

Figure 4.1 AU6438 Block Diagram

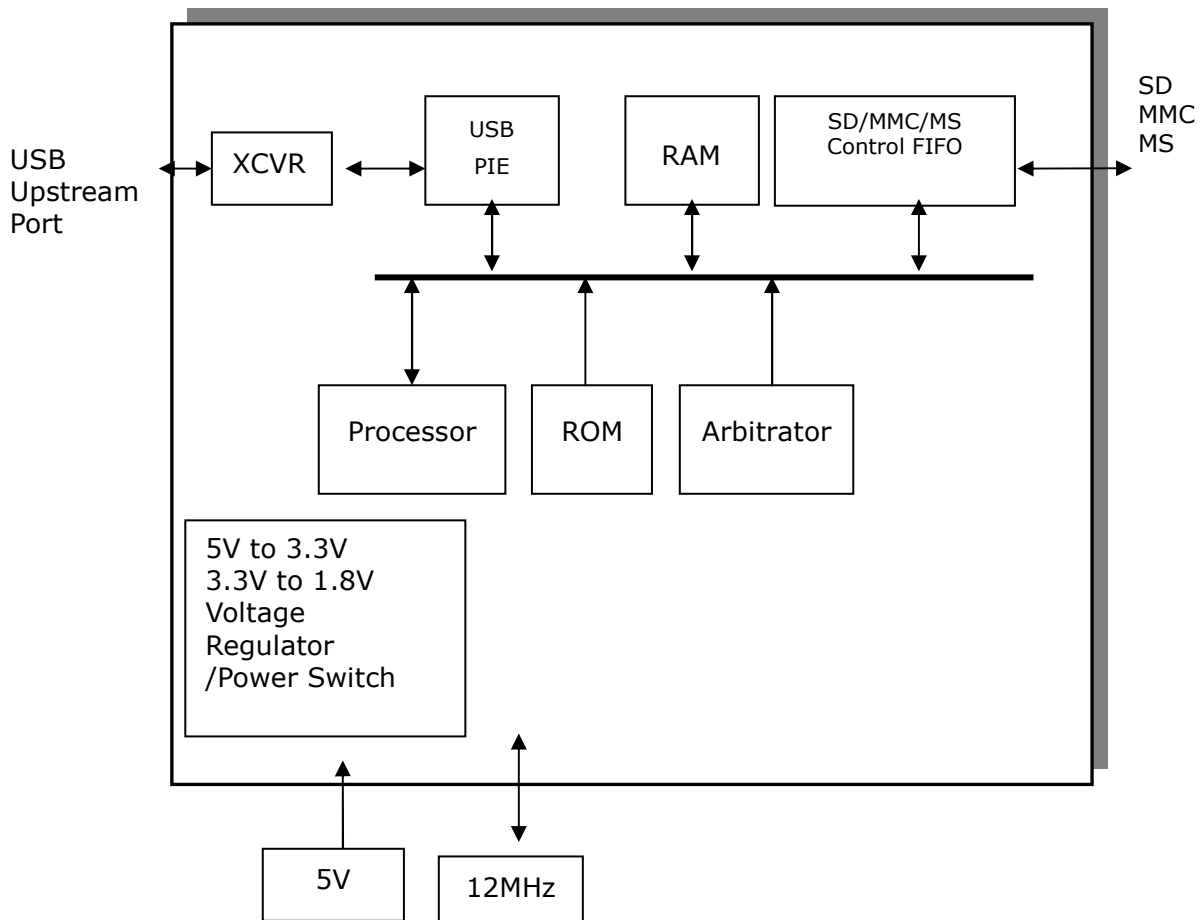



## 5. Electrical Characteristics

### 5.1 Absolute Maximum Ratings

**Table 5.1 Absolute Maximum Ratings**

SYMBOL	PARAMETER	RATING	UNITS
VCC33	Power supply	-1 to 4V	V
V <sub>IN</sub>	Input Signal Voltage	-1 to 4V	V
T <sub>STG</sub>	Storage Temperature	-40 to 150	°C

### 5.2 Recommended Operating Conditions

**Table 5.2 Recommended Operating Conditions**

SYMBOL	PARAMETER	MIN	TYP	MAX	UNITS
VCC33	Power Supply	3.0	3.3	3.6	V
V <sub>IN</sub>	Input Signal Voltage	-0.3		VCC33 +0.3	V
T <sub>OPR</sub>	Operating Temperature	0		85	°C

### 5.3 General DC Characteristics

**Table 5.3 General DC Characteristics**

SYMBOL	PARAMETER	CONDITIONS	MIN	TYP	MAX	UNITS
I <sub>IN</sub>	Input current	No pull-up or pull-down	-10	±1	10	μA
I <sub>OZ</sub>	Tri-state leakage current		-10	±1	10	μA
C <sub>IN</sub>	Input capacitance	Pad Limit		2.8		ρF
C <sub>OUT</sub>	Output capacitance	Pad Limit		2.8		ρF
C <sub>BID</sub>	Bi-directional buffer capacitance	Pad Limit		2.8		ρF
I <sub>CC</sub>	Operating supply current	Without Memory Card			24	mA



## 5.4 DC Electrical Characteristics of 3.3V I/O Cells

Table 5.4 DC Electrical Characteristics of 3.3V I/O Cells

SYMBOL	PARAMETER	CONDITIONS	Limits			UNIT
			MIN	TYP	MAX	
$V_{D33P}$	Power supply	3.3V I/O	3.0	3.3	3.6	V
$V_{il}$	Input low voltage	LVTTTL			0.8	V
$V_{ih}$	Input high voltage		2.0			V
$V_{ol}$	Output low voltage	$ I_{ol}  = 2\sim 16\text{mA}$			0.4	V
$V_{oh}$	Output high voltage	$ I_{oh}  = 2\sim 16\text{mA}$	2.4			V
$R_{pu}$	Input pull-up resistance	PU=high, PD=low	55	75	110	$K\Omega$
$R_{pd}$	Input pull-down resistance	PU=low, PD=high	40	75	150	$K\Omega$
$I_{in}$	Input leakage current	$V_{in} = V_{D33P}$ or 0	-10	$\pm 1$	10	$\mu A$
$I_{oz}$	Tri-state output leakage current		-10	$\pm 1$	10	$\mu A$

## 5.5 USB Transceiver Characteristics

Table 5.5 Electrical characteristics

Symbol	Parameter	Conditions	Min.	Typ.	Max.	Unit
VD33P	Analog supply Voltage		3.0	3.3	3.6	V
VDD V18	Digital supply Voltage		1.62	1.8	1.98	V



**Table 5.6 Static characteristic : Digital pin**

Symbol	Parameter	Conditions	Min.	Typ.	Max.	Unit
Input levels						
V <sub>IL</sub>	Low-level input voltage				0.8	V
V <sub>IH</sub>	High-level input voltage		2.0			V
Output levels						
V <sub>OL</sub>	Low-level output voltage				0.2	V
V <sub>OH</sub>	High-level output voltage		VD33P-0.2			V

**Table 5.7 Static characteristic : Analog I/O pins ( DP/DM )**

Symbol	Parameter	Conditions	Min.	Typ.	Max.	Unit
USB2.0 Transceiver ( HS )						
Input Levels ( differential receiver )						
V <sub>HSDIFF</sub>	High speed differential input sensitivity	$ V_{I(DP)} - V_{I(DM)} $ measured at the connection as application circuit	300			mV
V <sub>HSCM</sub>	High speed data signaling common mode voltage range		-50		500	mV
V <sub>HSSQ</sub>	High speed squelch detection threshold	Squelch detected			100	mV
		No squelch detected	150			mV
V <sub>HSDSC</sub>	High speed disconnection detection threshold	Disconnection detected	625			mV
		Disconnection not detected			525	mV
Output Levels						
V <sub>HSOI</sub>	High speed idle level output voltage(differential)		-10		10	mV
V <sub>HSOL</sub>	High speed low level output voltage(differential)		-10		10	mV
V <sub>HSHO</sub>	High speed high level output voltage(differential)		360		440	mV
V <sub>CHIRPJ</sub>	Chirp-J output voltage ( differential )		700		1100	mV
V <sub>CHIRPK</sub>	Chirp-K output voltage ( differential )		-900		-500	mV
Resistance						
R <sub>DRV</sub>	Driver output impedance	Equivalent resistance used as internal chip only	3	6	9	Ω



		Overall resistance including external resistor	40.5	45	49.5	
Termination						
$V_{TERM}$	Termination voltage for pull-up resistor on pin RPU		3.0		3.6	V
USB1.1 Transceiver (FS)						
Input Levels (differential receiver)						
$V_{DI}$	Differential input sensitivity	$ V_{I(DP)} - V_{I(DM)} $	0.2			V
$V_{CM}$	Differential common mode voltage		0.8		2.5	V
Input Levels (single-ended receivers)						
$V_{SE}$	Single ended receiver threshold		0.8		2.0	V
Output levels						
$V_{OL}$	Low-level output voltage		0		0.3	V
$V_{OH}$	High-level output voltage		2.8		3.6	V

**Table 5.8 Dynamic characteristic : Analog I/O pins (DP/DM)**

Symbol	Parameter	Conditions	Min.	Typ.	Max.	Unit
Driver Characteristics						
High-Speed Mode						
$t_{HSR}$	High-speed differential rise time		500			ps
$t_{HSF}$	High-speed differential fall time		500			ps
Full-Speed Mode						
$t_{FR}$	Rise time	CL=50pF ; 10 to 90% of $ V_{OH}-V_{OL} $ ;	4		20	ns
$t_{FF}$	Fall time	CL=50pF ; 90 to 10% of $ V_{OH}-V_{OL} $ ;	4		20	ns
$t_{FRMA}$	Differential rise/fall time matching ( $t_{FR} / t_{FF}$ )	Excluding the first transition from idle mode	90		110	%
$V_{CRS}$	Output signal crossover voltage	Excluding the first transition from idle mode	1.3		2.0	V





## 5.6 Power Switch Feature

Figure 5.1 Card Power Switch Output Capacity

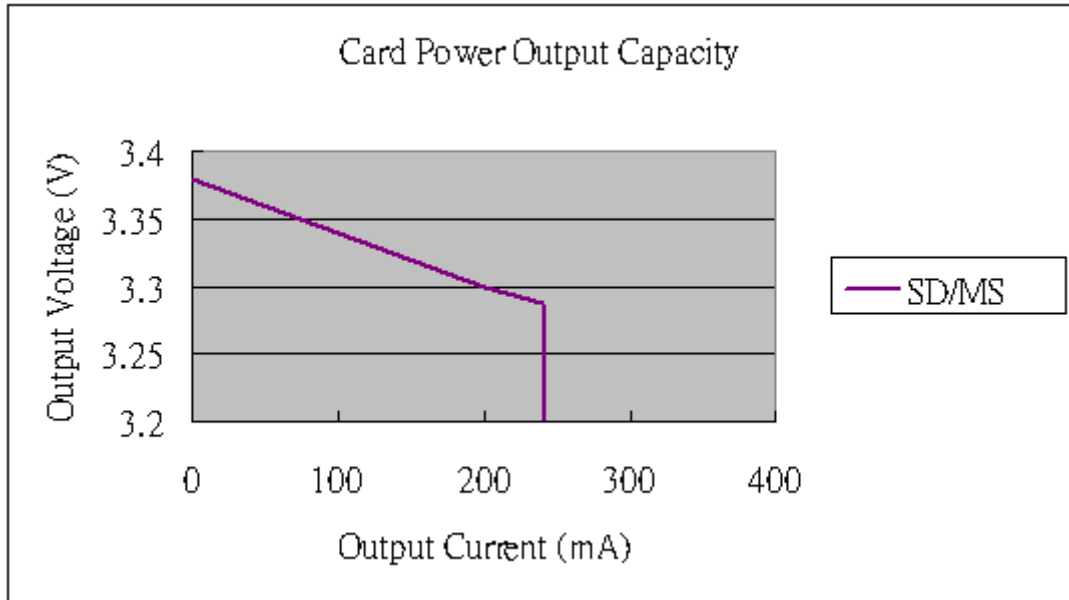
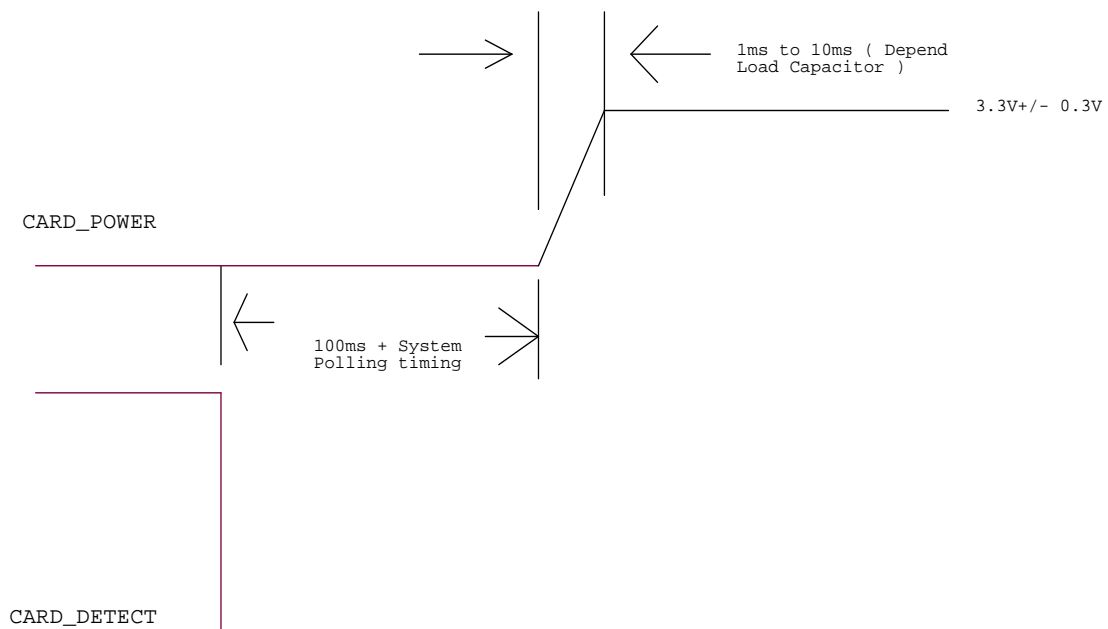

Figure 5.2 Card Detect Power-in Timing





### 5.7 Chip Reset Timing

Figure 5.3 Chip Reset Timing.

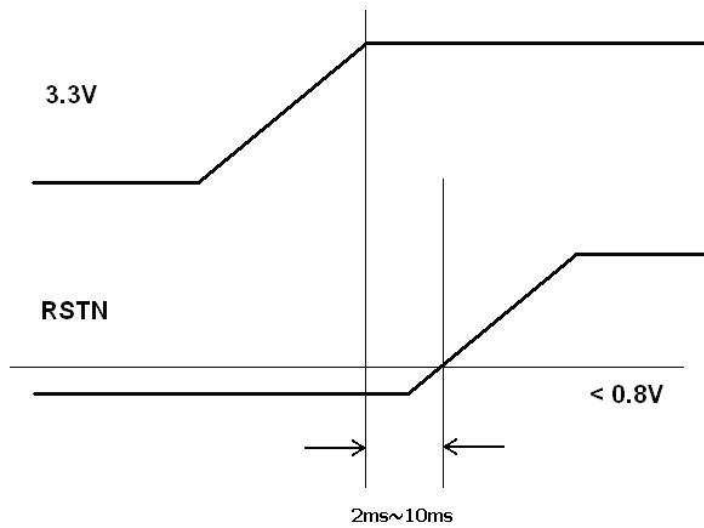

Chip reset should keep low (<0.8V) for 2ms ~ 10ms after:

1. 3.3V stable.
2. Clock stable



# 6. Mechanical Information

Figure 6.1 Mechanical Information Diagram

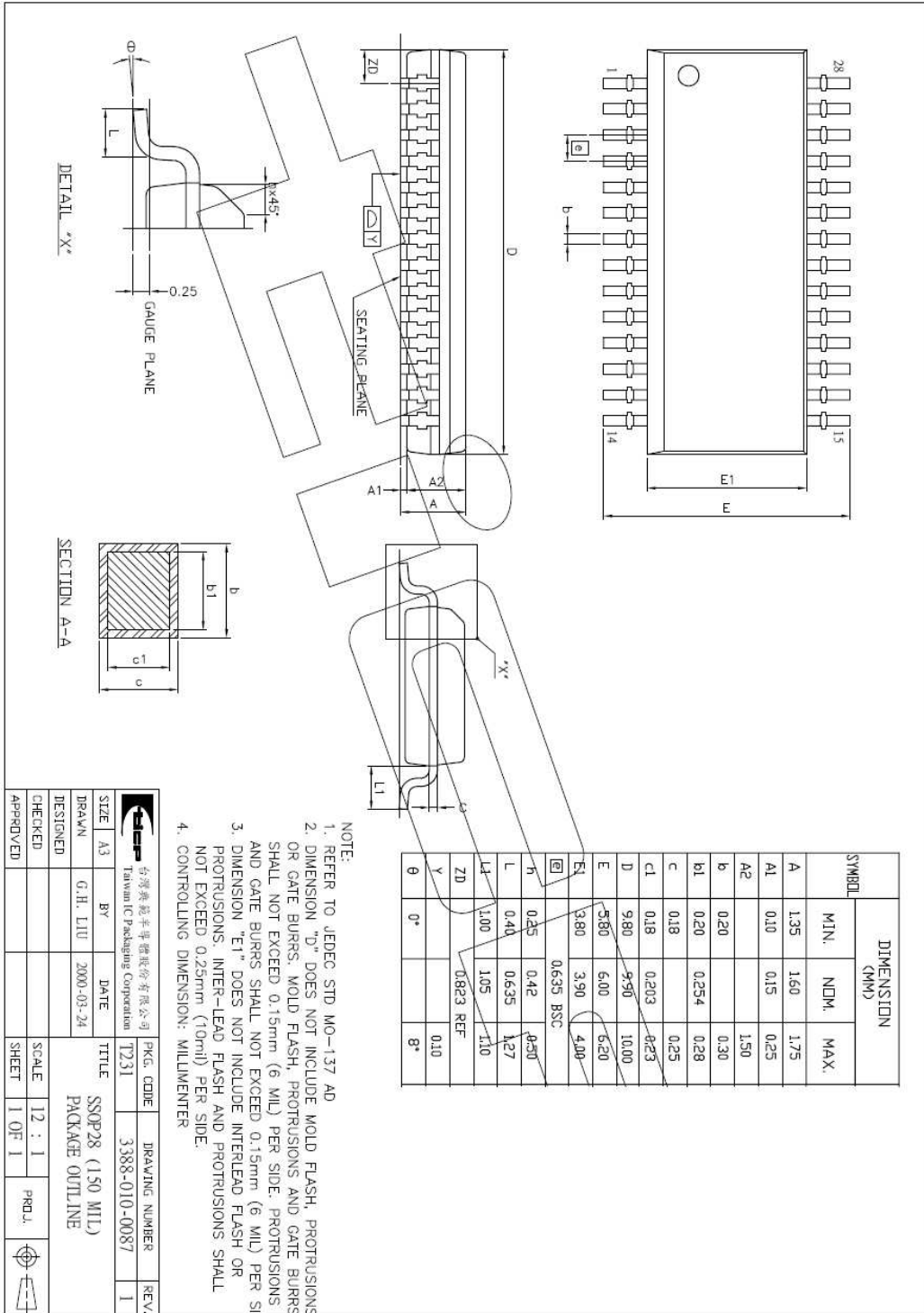



## 7. Abbreviations

In this chapter some of the terms and abbreviations used throughout the technical reference manual are listed as follows.

<b>SIE</b>	Serial Interface Engine
<b>CF</b>	Compact Flash
<b>MD</b>	Micro Drive
<b>SMC</b>	SmartMedia Card
<b>MS</b>	Memory Stick
<b>SD</b>	Secure Digital
<b>MMC</b>	Multimedia Card
<b>UTMI</b>	USB Transceiver Macrocell Interface

## About Alcor Micro, Corp.

Alcor Micro, Corp. designs, develops and markets highly integrated and advanced peripheral semiconductor, and software driver solutions for the personal computer and consumer electronics markets worldwide. We specialize in USB solutions and focus on emerging technology such as USB and IEEE 1394. The company offers a range of semiconductors including controllers for USB hub, integrated keyboard/USB hub and USB Flash memory card reader...etc. Alcor Micro, Corp. is based in Taipei, Taiwan, with sales offices in Taipei, Japan, Korea and California. Alcor Micro is distinguished by its ability to provide innovative solutions for spec-driven products. Innovations like single chip solutions for traditional multiple chip products and on-board voltage regulators enable the company to provide cost-efficiency solutions for the computer peripheral device OEM customers worldwide.