

【*】[®] 慈溪市东威电子有限公司
CIXI CITY DONGWEI ELECTRONICS CO., LTD

SPECIFICATION



客 户
 CUSTOMER: _____

品 名
 TITLE: 拨码开关 (DIP SWITCH)

型 号
 PART ON.: HAM-04HWA-R

客 户 型 号
 CUSTOMER PART NO.: _____

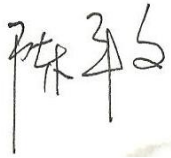
日 期
 DATE: _____

制 样 DESIGNED BY	审 核 CHECKED BY	批 准 APPROVED BY	送样印 SENDING PRINT
	Alice		
客 户 确 认 CUSTOMER APPROVAL		承 认 印 APPD PRINT	

地址: 浙江省慈溪市逍林青春路245号
 Add: No#245 qingchun road, xiaolin, cixi, zhejiang
 电话(Tel): +86-574-63501386 63501528
 传真(Fax): +86-574-63500156
 邮编(P. C.): 315321
[Http://www.tonver.com](http://www.tonver.com)
 E-mail: tonver@tonver.com

制品规格 SPECIFICATIONS OF PRODUCTS

文件编号 DOCUMENT NO.	DW-SP-011-04	发行日期 ISSUED DATE	2012-4-17	版本: 2.0 VERSION	页次: 2/4 PAGE
----------------------	--------------	---------------------	-----------	--------------------	-----------------

1. 材料 MATERIALS

	上盖: 工程塑料, 黑色	COVER: Engineering Plastics, Black
	底座: 工程塑料, 黑色	BASE: Engineering Plastics, Black
	按键: 工程塑料, 白色或橙色	KEY: Engineering Plastics, White or orange
	端子: 铜合金, 镀金或者镀锡	TERMINAL: Alloy Copper, Plating Gold or Tin

2. 产品命名 PRODUCT NAMING

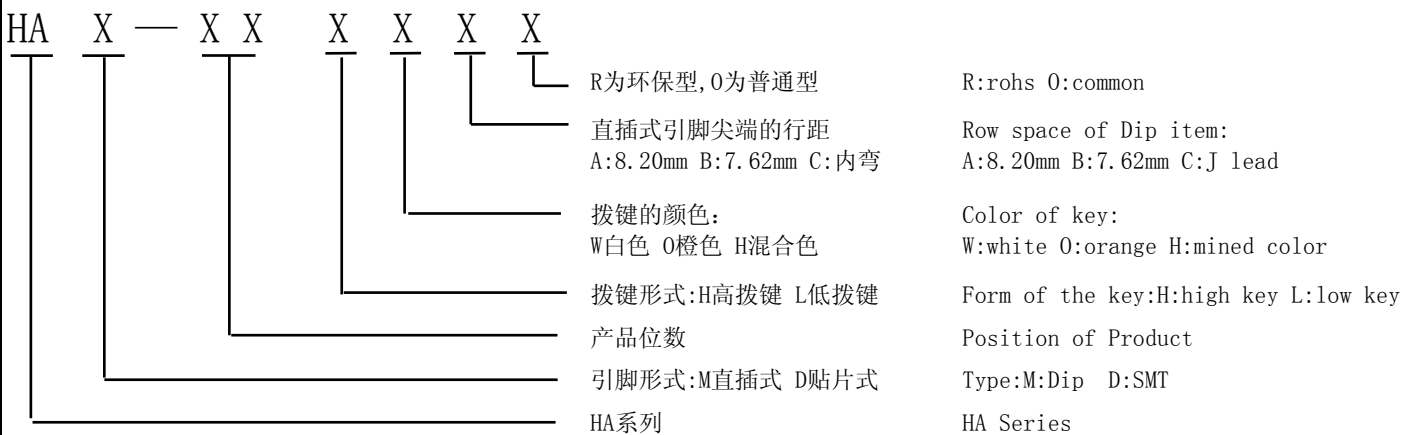

3. 产品位数代号 NUMBER OF POSITIONS

01	02	03	04	05	06	07	08	09	10	12
一位	二位	三位	四位	五位	六位	七位	八位	九位	十位	十二位
one	two	three	four	five	six	seven	eight	nine	ten	twelve

4. 电气性能 ELECTRICAL CHARACTERISTICS

项目 ITME		性能 PERFORMANCE
4.1	接触电阻(初始值) CONTACT RESISTANCE (INITIAL) :	≤50mΩ
4.2	接触电阻(测试后) (AFTER LIFE TEST) :	≤100mΩ
4.3	开关容量(开关常切换) CONTACT RATING (CONTACT RATING) :	25mA 24VDC
4.4	开关容量(开关不常切换) CONTACT RATING (NON-CONTACT RATING) :	100mA
4.5	绝缘电阻 INSULATION RESISTANCE:	≥100MΩ .Min. at 500VDC
4.6	耐压强度 DIELECTRIC STRENGTH:	500VAC Min. for 60 seconds. 1mA
4.7	极际电容 CAPACITANCE BETWEEN ADJACENT SWITCHES:	≤5PF



5. 机械特性 MECHANICAL

项目 ITME		性能 PERFORMANCE
5.1	操作力 OPERATION FORCE:	≤8N
5.2	机械寿命 MECHANICAL LIFE:	2000 operations



制品规格 SPECIFICATIONS OF PRODUCTS

文件编号 DOCUMENT NO.	DW-SP-011-04	发行日期 ISSUED DATE	2012-4-17	版本: 2.0 VERSION	页次: 3/4 PAGE
项目 ITME					性能 PERFORMANCE
5.3	使用温度 OPERATING TEMPERATURE:				-20°C ~ +70°C
5.4	储存温度 STORAGE TEMPERATURE:				-40°C ~ +85°C
5.5	可焊性 SOLDERABILITY:				After flux 230±5°C for 5 ±0.5seconds, 95%coverage
5.6	耐焊接热 RESISTANCE TO SOLDERING HEAT:				260±5°C for 5±1seconds

6. 焊接和清洗 SOLDERING AND CLEANING PROCESSES

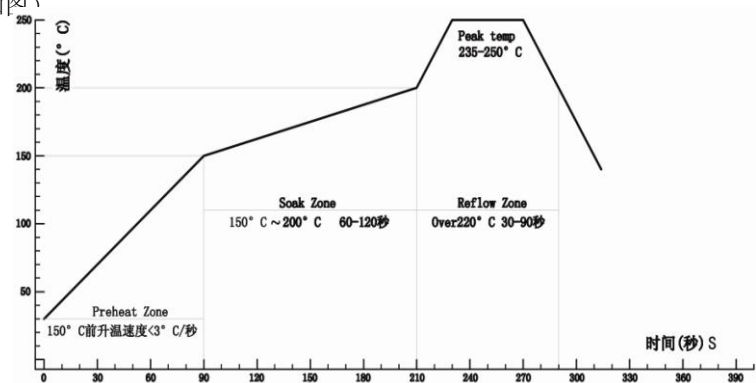
6.1	在所有操作过程中, 请确保开关在OFF位置	Keep all switch contacts in their "OFF" position for all operations
6.2	波焊: 推荐焊接焊锡温度为500° F(260°C), 最多5秒	WAVE SOLDERING: Recommended solder temperature at 500° F(260°C) max.5 seconds
6.3	手焊: 使用30W烙铁控制温度在350°C, 焊接时间大约5秒钟	HAND SOLDERING: Use a soldering iron of 30 Watts controlled at 350°C approximately 5 seconds. While
6.4	回流焊: (SMT型) 回流炉最高温度为250°C, 温度为250°C时, 最长不超过10秒 (如图)	Reflow Soldering Profile: (reference) 

7. 产品包装 PACKING

7.1	所有拨码产品皆以IC管形式包装 HA系列包装资料	All Code Switches are shipped in standard IC tube Packing of HA																																																		
	<table border="1"> <thead> <tr> <th>系列 SERIES</th> <th>开关位数 NO.of POS</th> <th>每管数量 PER TUBE</th> <th>每小箱数量 PER BOX</th> <th>外箱包装 PERCTN</th> </tr> </thead> <tbody> <tr><td>HA</td><td>1</td><td>130PCS</td><td>13000PCS</td><td rowspan="12">6 BOXES 55.5×30.5×40CM</td></tr> <tr><td>HA</td><td>2</td><td>77PCS</td><td>7700PCS</td></tr> <tr><td>HA</td><td>3</td><td>55PCS</td><td>5500PCS</td></tr> <tr><td>HA</td><td>4</td><td>42PCS</td><td>4200PCS</td></tr> <tr><td>HA</td><td>5</td><td>34PCS</td><td>3400PCS</td></tr> <tr><td>HA</td><td>6</td><td>29PCS</td><td>2900PCS</td></tr> <tr><td>HA</td><td>7</td><td>25PCS</td><td>2500PCS</td></tr> <tr><td>HA</td><td>8</td><td>22PCS</td><td>2200PCS</td></tr> <tr><td>HA</td><td>9</td><td>20PCS</td><td>2000PCS</td></tr> <tr><td>HA</td><td>10</td><td>18PCS</td><td>1800PCS</td></tr> <tr><td>HA</td><td>12</td><td>15PCS</td><td>1500PCS</td></tr> </tbody> </table>		系列 SERIES	开关位数 NO.of POS	每管数量 PER TUBE	每小箱数量 PER BOX	外箱包装 PERCTN	HA	1	130PCS	13000PCS	6 BOXES 55.5×30.5×40CM	HA	2	77PCS	7700PCS	HA	3	55PCS	5500PCS	HA	4	42PCS	4200PCS	HA	5	34PCS	3400PCS	HA	6	29PCS	2900PCS	HA	7	25PCS	2500PCS	HA	8	22PCS	2200PCS	HA	9	20PCS	2000PCS	HA	10	18PCS	1800PCS	HA	12	15PCS	1500PCS
	系列 SERIES	开关位数 NO.of POS	每管数量 PER TUBE	每小箱数量 PER BOX	外箱包装 PERCTN																																															
	HA	1	130PCS	13000PCS	6 BOXES 55.5×30.5×40CM																																															
	HA	2	77PCS	7700PCS																																																
	HA	3	55PCS	5500PCS																																																
	HA	4	42PCS	4200PCS																																																
	HA	5	34PCS	3400PCS																																																
	HA	6	29PCS	2900PCS																																																
	HA	7	25PCS	2500PCS																																																
	HA	8	22PCS	2200PCS																																																
	HA	9	20PCS	2000PCS																																																
HA	10	18PCS	1800PCS																																																	
HA	12	15PCS	1500PCS																																																	



制品规格 SPECIFICATIONS OF PRODUCTS

文件编号 DOCUMENT NO.	DW-SP-011-04	发行日期 ISSUED DATE	2012-4-17	版本: 2.0 VERSION	页次: 4/4 PAGE
----------------------	--------------	---------------------	-----------	--------------------	-----------------

8. 产品外形及装配图纸 SHAPE AND ASSEMBLY SIZE

DIMENSION A (General tolerance: ± 0.3)

POSITIONS	1	2	3	4	5	6	7	8	9	10	12
A	3.64	6.18	8.72	11.26	13.80	16.34	18.88	21.42	23.96	26.50	31.58

HAM DIMENSIONS Unit:mm

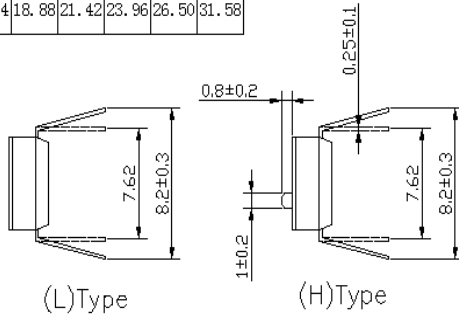
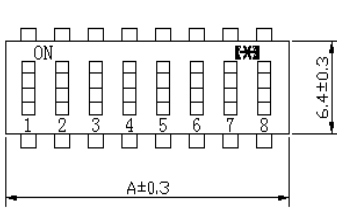

ITEM	DES	MATERIALS	TREATMENT
1	COVER	ENGINEERING PLASTICS	BLACK
2	BASE	ENGINEERING PLASTICS	BLACK
3	KEY	ENGINEERING PLASTICS	WHITE
4	TERMINAL	ALLOY COPPER	PLATING GOLD

