

# MURS120T3 Series

Preferred Devices

## Surface Mount Ultrafast Power Rectifiers

MURS105T3, MURS110T3, MURS115T3,  
MURS120T3, MURS140T3, MURS160T3

Ideally suited for high voltage, high frequency rectification, or as free wheeling and protection diodes in surface mount applications where compact size and weight are critical to the system.

### Features

- Pb-Free Packages are Available
- Small Compact Surface Mountable Package with J-Bend Leads
- Rectangular Package for Automated Handling
- High Temperature Glass Passivated Junction
- Low Forward Voltage Drop (0.71 to 1.05 Volts Max @ 1.0 A,  $T_J = 150^\circ\text{C}$ )

### Mechanical Characteristics

- Case: Epoxy, Molded
- Weight: 95 mg (approximately)
- Finish: All External Surfaces Corrosion Resistant and Terminal Leads are Readily Solderable
- Lead and Mounting Surface Temperature for Soldering Purposes:  $260^\circ\text{C}$  Max. for 10 Seconds
- Polarity: Polarity Band Indicates Cathode Lead



ON Semiconductor®

<http://onsemi.com>

ULTRAFAST RECTIFIERS  
1.0 AMPERE  
50-600 VOLTS



SMB  
CASE 403A

### MARKING DIAGRAM

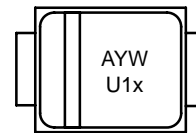

U1 = Device Code  
x = A, B, C, D, G or J  
A = Assembly Location  
Y = Year  
W = Work Week

### ORDERING INFORMATION

See detailed ordering and shipping information in the table on page 2 of this data sheet.

### DEVICE MARKING INFORMATION

See general marking information in the device marking table on page 2 of this data sheet.

**Preferred** devices are recommended choices for future use and best overall value.

# MURS120T3 Series

## MAXIMUM RATINGS

Rating	Symbol	MURS						Unit
		105T3	110T3	115T3	120T3	140T3	160T3	
Peak Repetitive Reverse Voltage Working Peak Reverse Voltage DC Blocking Voltage	$V_{RRM}$ $V_{RWM}$ $V_R$	50	100	150	200	400	600	V
Average Rectified Forward Current	$I_{F(AV)}$	1.0 @ $T_L = 155^\circ\text{C}$ 2.0 @ $T_L = 145^\circ\text{C}$			1.0 @ $T_L = 150^\circ\text{C}$ 2.0 @ $T_L = 125^\circ\text{C}$			A
Non-Repetitive Peak Surge Current (Surge applied at rated load conditions halfwave, single phase, 60 Hz)	$I_{FSM}$	40			35			A
Operating Junction Temperature	$T_J$	- 65 to +175						$^\circ\text{C}$

Maximum ratings are those values beyond which device damage can occur. Maximum ratings applied to the device are individual stress limit values (not normal operating conditions) and are not valid simultaneously. If these limits are exceeded, device functional operation is not implied, damage may occur and reliability may be affected.

## THERMAL CHARACTERISTICS

Thermal Resistance, Junction-to-Lead ( $T_L = 25^\circ\text{C}$ )	$R_{\theta JL}$	13	$^\circ\text{C}/\text{W}$
--	-----------------	----	---------------------------

## ELECTRICAL CHARACTERISTICS

Maximum Instantaneous Forward Voltage (Note 1) ( $i_F = 1.0\text{ A}$ , $T_J = 25^\circ\text{C}$ ) ( $i_F = 1.0\text{ A}$ , $T_J = 150^\circ\text{C}$ )	$V_F$	0.875 0.71	1.25 1.05	V
Maximum Instantaneous Reverse Current (Note 1) (Rated DC Voltage, $T_J = 25^\circ\text{C}$ ) (Rated DC Voltage, $T_J = 150^\circ\text{C}$ )	$i_R$	2.0 50	5.0 150	$\mu\text{A}$
Maximum Reverse Recovery Time ( $i_F = 1.0\text{ A}$ , $di/dt = 50\text{ A}/\mu\text{s}$ ) ( $i_F = 0.5\text{ A}$ , $i_R = 1.0\text{ A}$ , $I_R$ to $0.25\text{ A}$ )	$t_{rr}$	35 25	75 50	ns
Maximum Forward Recovery Time ( $i_F = 1.0\text{ A}$ , $di/dt = 100\text{ A}/\mu\text{s}$ , Rec. to $1.0\text{ V}$ )	$t_{fr}$	25	50	ns

1. Pulse Test: Pulse Width = 300  $\mu\text{s}$ , Duty Cycle  $\leq 2.0\%$ .

## DEVICE MARKING AND ORDERING INFORMATION

Device	Marking	Package	Shipping†
MURS105T3	U1A	SMB	2500 Units/Tape & Reel
MURS110T3	U1B	SMB	2500 Units/Tape & Reel
MURS115T3	U1C	SMB	2500 Units/Tape & Reel
MURS120T3	U1D	SMB	2500 Units/Tape & Reel
MURS120T3G	U1D	SMB (Pb-Free)	2500 Units/Tape & Reel
MURS140T3	U1G	SMB	2500 Units/Tape & Reel
MURS140T3G	U1G	SMB (Pb-Free)	2500 Units/Tape & Reel
MURS160T3	U1J	SMB	2500 Units/Tape & Reel
MURS160T3G	U1J	SMB (Pb-Free)	2500 Units/Tape & Reel

†For information on tape and reel specifications, including part orientation and tape sizes, please refer to our Tape and Reel Packaging Specifications Brochure, BRD8011/D.

# MURS120T3 Series

## MURS105T3, MURS110T3, MURS115T3, MURS120T3

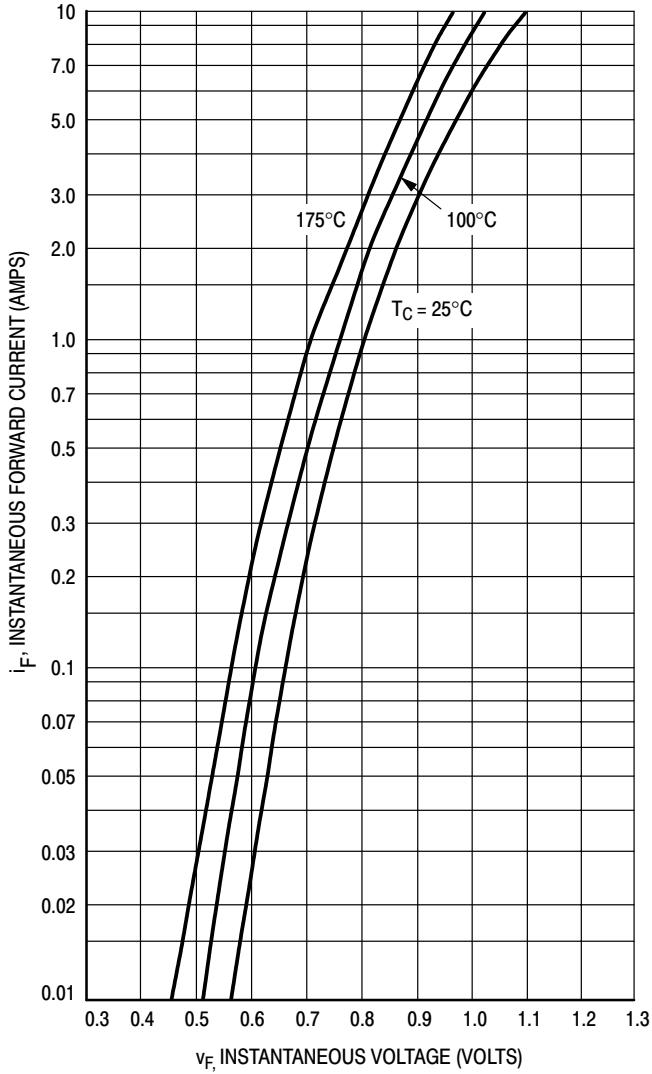

Figure 1. Typical Forward Voltage

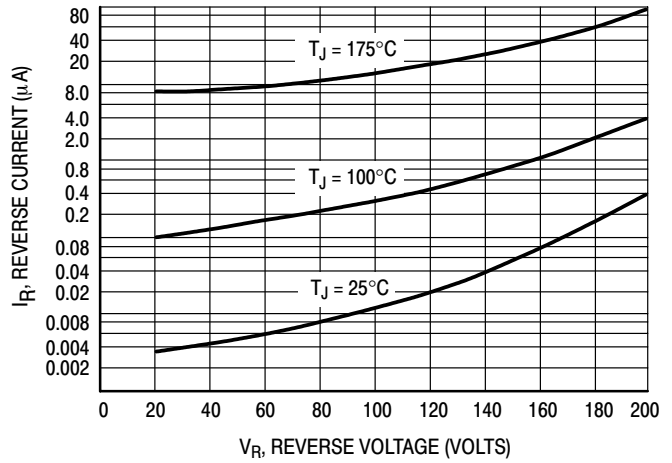

Figure 2. Typical Reverse Current\*

\* The curves shown are typical for the highest voltage device in the voltage grouping. Typical reverse current for lower voltage selections can be estimated from these same curves if applied  $V_R$  is sufficiently below rated  $V_R$ .

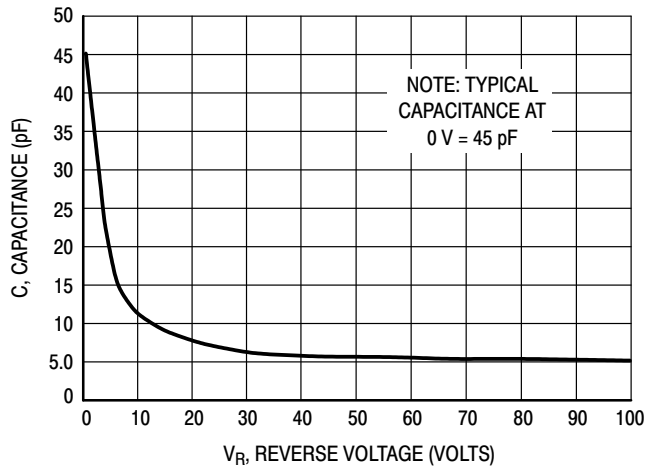

Figure 3. Typical Capacitance

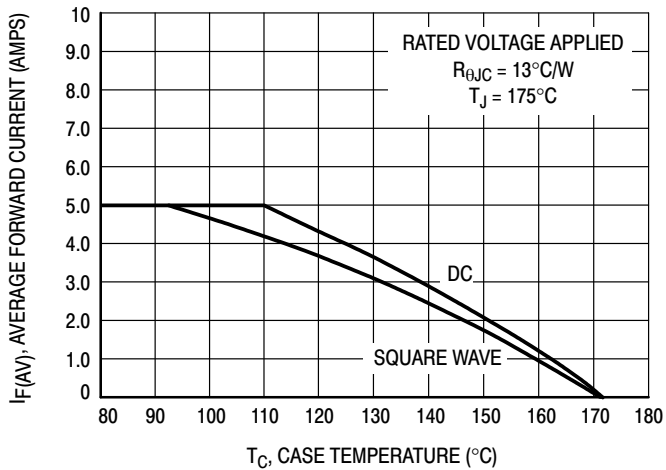

Figure 4. Current Derating, Case

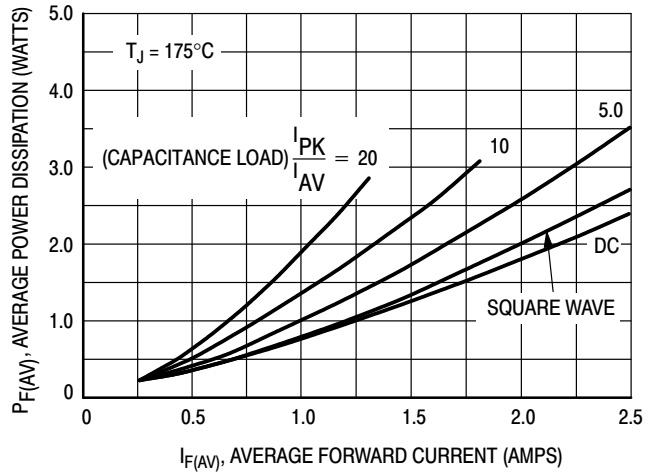

Figure 5. Power Dissipation

# MURS120T3 Series

## MURS140T3, MURS160T3

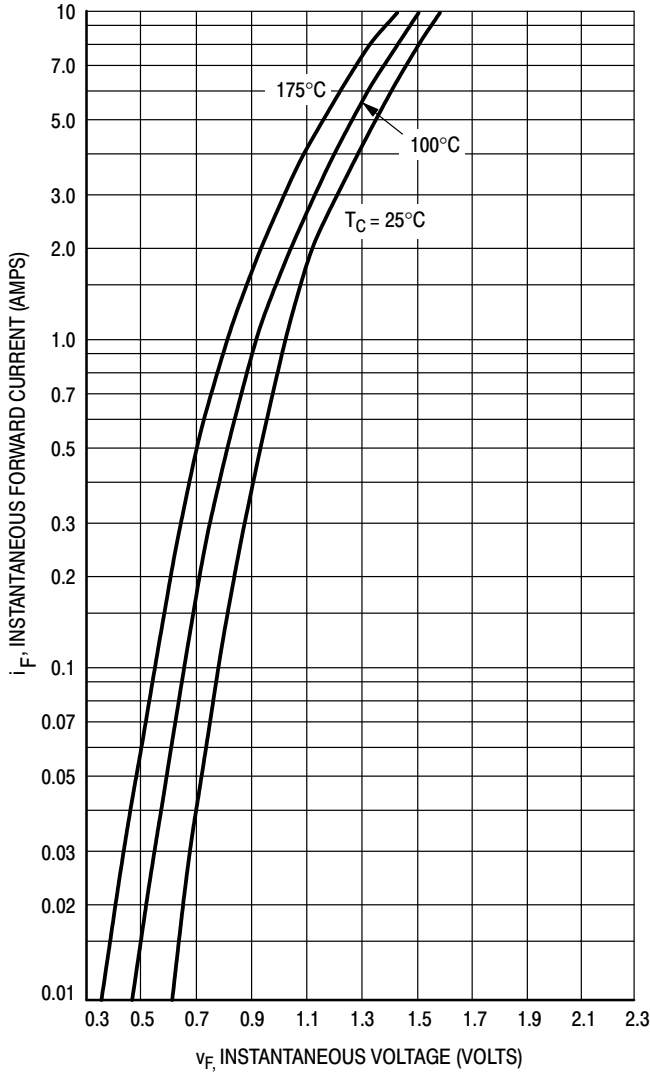

Figure 6. Typical Forward Voltage

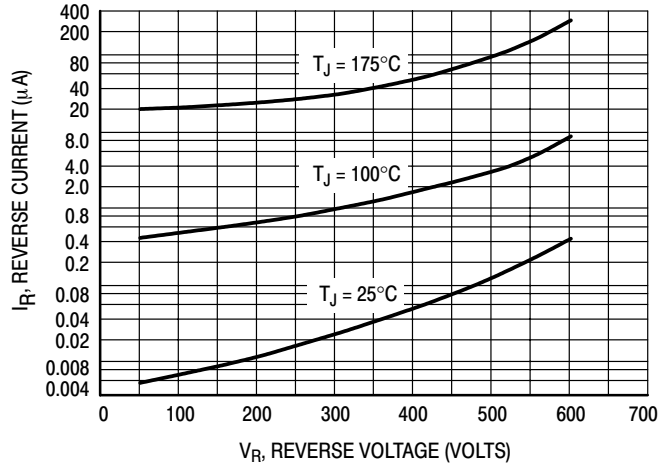

Figure 7. Typical Reverse Current\*

\* The curves shown are typical for the highest voltage device in the voltage grouping. Typical reverse current for lower voltage selections can be estimated from these same curves if applied  $V_R$  is sufficiently below rated  $V_R$ .

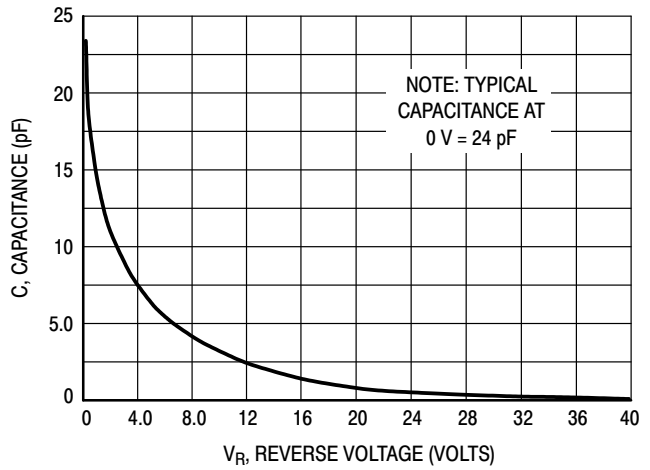

Figure 8. Typical Capacitance

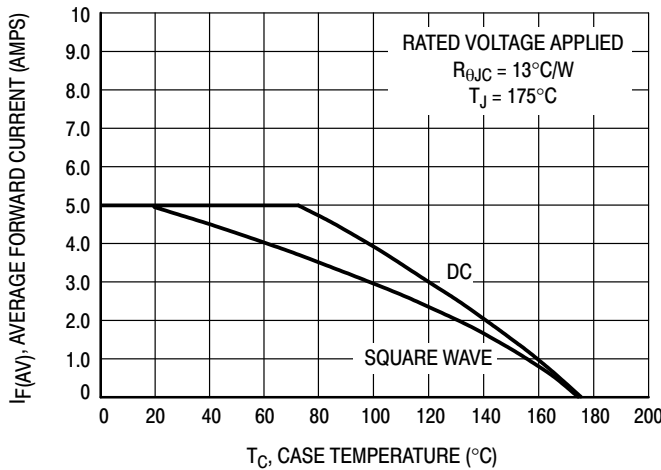

Figure 9. Current Derating, Case

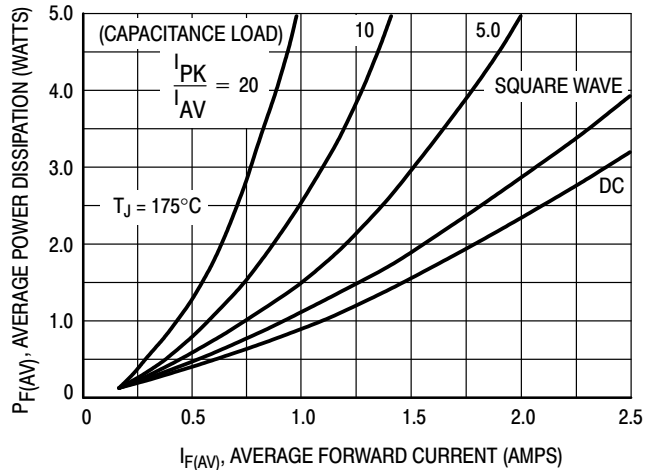
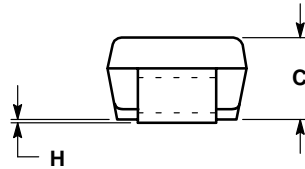
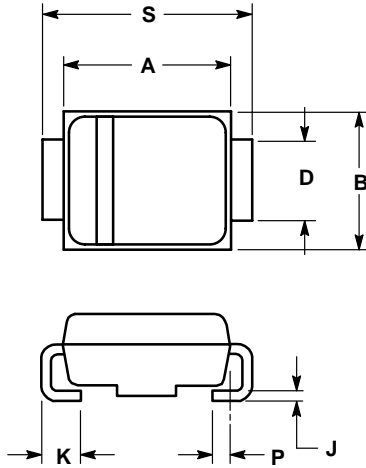

Figure 10. Power Dissipation

# MURS120T3 Series

## PACKAGE DIMENSIONS

**SMB**  
**DO-214AA**  
CASE 403A-03  
ISSUE D



**NOTES:**

1. DIMENSIONING AND TOLERANCING PER ANSI Y14.5M, 1982.
2. CONTROLLING DIMENSION: INCH.
3. D DIMENSION SHALL BE MEASURED WITHIN DIMENSION P.

DIM	INCHES		MILLIMETERS	
	MIN	MAX	MIN	MAX
A	0.160	0.180	4.06	4.57
B	0.130	0.150	3.30	3.81
C	0.075	0.095	1.90	2.41
D	0.077	0.083	1.96	2.11
H	0.0020	0.0060	0.051	0.152
J	0.006	0.012	0.15	0.30
K	0.030	0.050	0.76	1.27
P	0.020	REF	0.51	REF
S	0.205	0.220	5.21	5.59

### SOLDERING FOOTPRINT\*

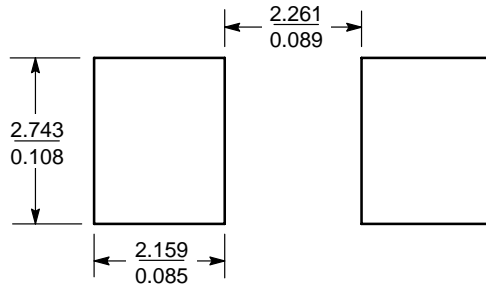

SCALE 8:1  $\left(\frac{\text{mm}}{\text{inches}}\right)$

\*For additional information on our Pb-Free strategy and soldering details, please download the ON Semiconductor Soldering and Mounting Techniques Reference Manual, SOLDERRM/D.

# MURS120T3 Series

**ON Semiconductor** and  are registered trademarks of Semiconductor Components Industries, LLC (SCILLC). SCILLC reserves the right to make changes without further notice to any products herein. SCILLC makes no warranty, representation or guarantee regarding the suitability of its products for any particular purpose, nor does SCILLC assume any liability arising out of the application or use of any product or circuit, and specifically disclaims any and all liability, including without limitation special, consequential or incidental damages. "Typical" parameters which may be provided in SCILLC data sheets and/or specifications can and do vary in different applications and actual performance may vary over time. All operating parameters, including "Typicals" must be validated for each customer application by customer's technical experts. SCILLC does not convey any license under its patent rights nor the rights of others. SCILLC products are not designed, intended, or authorized for use as components in systems intended for surgical implant into the body, or other applications intended to support or sustain life, or for any other application in which the failure of the SCILLC product could create a situation where personal injury or death may occur. Should Buyer purchase or use SCILLC products for any such unintended or unauthorized application, Buyer shall indemnify and hold SCILLC and its officers, employees, subsidiaries, affiliates, and distributors harmless against all claims, costs, damages, and expenses, and reasonable attorney fees arising out of, directly or indirectly, any claim of personal injury or death associated with such unintended or unauthorized use, even if such claim alleges that SCILLC was negligent regarding the design or manufacture of the part. SCILLC is an Equal Opportunity/Affirmative Action Employer. This literature is subject to all applicable copyright laws and is not for resale in any manner.

## PUBLICATION ORDERING INFORMATION

### LITERATURE FULFILLMENT:

Literature Distribution Center for ON Semiconductor  
P.O. Box 61312, Phoenix, Arizona 85082-1312 USA

**Phone:** 480-829-7710 or 800-344-3860 Toll Free USA/Canada

**Fax:** 480-829-7709 or 800-344-3867 Toll Free USA/Canada

**Email:** [orderlit@onsemi.com](mailto:orderlit@onsemi.com)

**N. American Technical Support:** 800-282-9855 Toll Free  
USA/Canada

**Japan:** ON Semiconductor, Japan Customer Focus Center  
2-9-1 Kamimeguro, Meguro-ku, Tokyo, Japan 153-0051  
**Phone:** 81-3-5773-3850

**ON Semiconductor Website:** <http://onsemi.com>

**Order Literature:** <http://www.onsemi.com/litorder>

For additional information, please contact your  
local Sales Representative.

This datasheet has been download from:

[www.datasheetcatalog.com](http://www.datasheetcatalog.com)

Datasheets for electronics components.