

## Transient Voltage Suppressors - 5KP Series

### Features

1. Halogen-free
2. Rohs compliant
3. Typical maximum temperature coefficient
4.  $\Delta V_{BR} = 0.1\% \times V_{BR} @ 25^{\circ}\text{C} \times \Delta T$
5. Glass passivated Chip junction in P800 package
6. 5000W peak pulse capability at 10x1000 $\mu\text{s}$  waveform, repetition rate (duty cycles): 0.01%
7. Fast response time: typically less than 1.0ps from 0 Volts to BV min
8. Excellent clamping capability
9. Low incremental surge resistance
10. Typical IR less than 5 $\mu\text{A}$  above 11V
11. High temperature soldering guaranteed: 260 $^{\circ}\text{C}/40$  seconds / 0.375", (9.5mm) lead length, 5lbs., (2.3kg) tension
12. Plastic package has underwriters laboratory flammability classification 94v-0

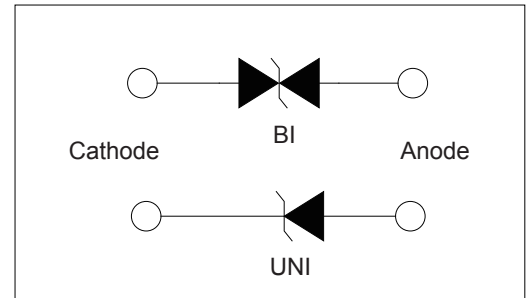
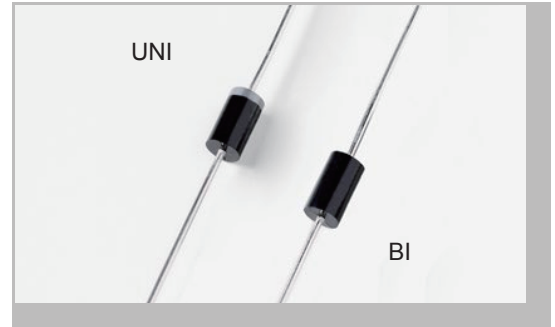

### Applications

TVS devices are ideal for the protection of I/O interfaces, VCC bus and other vulnerable circuits used in telecom, computer, industrial and consumer electronic applications.

### Mechanical Characteristics

Rating	Symbol	Value	Units
Peak Pulse Power Dissipation by 10x1000 $\mu\text{s}$ test waveform (Fig.1)(Note 1)	$P_{PPM}$	5000	Watts
Steady State Power Dissipation on infinite heat sink at $T_L=75^{\circ}\text{C}$ (Fig. 5)	$P_D$	8	Watts
Peak Forward Surge Current, 8.3ms Single Half Sine Wave Unidirectional only (Note 2)	$I_{FSM}$	400	Amps
Maximum Instantaneous Forward Voltage at 25A for Unidirectional only (Note 3)	$V_F$	3.5/5.0	V
Operating junction and Storage Temperature Range.	$T_J, T_{STG}$	-55 $^{\circ}\text{C}$ to 175 $^{\circ}\text{C}$	$^{\circ}\text{C}$
Typical Thermal Resistance Junction to Lead	$R_{\theta JL}$	8.0	$^{\circ}\text{C}/\text{W}$
Typical Thermal Resistance Junction to Ambient	$R_{\theta JA}$	40	$^{\circ}\text{C}/\text{W}$

Notes:

1. Non-repetitive current pulse, per Fig. 3 and derated above  $T_A = 25^{\circ}\text{C}$  per Fig. 2.
2. Measured on 8.3ms single half sine wave or equivalent square wave, duty cycle=4 per minute maximum.
3.  $V_F < 3.5\text{V}$  for devices of  $V_{BR} < 200\text{V}$  and  $V_F < 5.0\text{V}$  for devices of  $V_{BR} > 201\text{V}$ .

## Electrical Characteristics

Type Number		Reverse Stand-Off Voltage $V_{RWM}(V)$	Breakdown Voltage @ $I_T$		Test Current $I_T(mA)$	Maximum Clamping Voltage @ $I_{PP}$ $V_C(V)$	Peak Pulse Current $I_{PP}(A)$	Reverse Leakage @ $V_{RWM}$ $I_R(\mu A)$
(UNI)	(BI)		$V_{BR MIN.}(V)$	$V_{BR MAX.}(V)$				
5KP5.0A	5KP5.0CA	5.0	6.40	7.00	50	9.2	554.3	5000
5KP6.0A	5KP6.0CA	6.0	6.67	7.37	50	10.3	495.1	5000
5KP6.5A	5KP6.5CA	6.5	7.22	7.98	50	11.2	445.4	2000
5KP7.0A	5KP7.0CA	7.0	7.78	8.60	50	12.0	425.0	1000
5KP7.5A	5KP7.5CA	7.5	8.33	9.21	5	12.9	395.3	250
5KP8.0A	5KP8.0CA	8.0	8.89	9.83	5	13.6	375.0	150
5KP8.5A	5KP8.5CA	8.5	9.44	10.40	5	14.4	354.2	50
5KP9.0A	5KP9.0CA	9.0	10.00	11.10	5	15.4	331.2	20
5KP10A	5KP10CA	10.0	11.10	12.30	5	17.0	300.0	15
5KP11A	5KP11CA	11.0	12.20	13.50	5	18.2	280.2	5
5KP12A	5KP12CA	12.0	13.30	14.70	5	19.9	256.3	5
5KP13A	5KP13CA	13.0	14.40	15.90	5	21.5	237.2	5
5KP14A	5KP14CA	14.0	15.60	17.20	5	23.2	219.8	5
5KP15A	5KP15CA	15.0	16.70	18.50	5	24.4	209.0	5
5KP16A	5KP16CA	16.0	17.80	19.70	5	26.0	196.2	5
5KP17A	5KP17CA	17.0	18.90	20.90	5	27.6	184.8	5
5KP18A	5KP18CA	18.0	20.00	22.10	5	29.2	174.7	5
5KP20A	5KP20CA	20.0	22.20	24.50	5	32.4	157.4	5
5KP22A	5KP22CA	22.0	24.00	26.90	5	35.5	143.7	5
5KP24A	5KP24CA	24.0	26.70	29.50	5	38.9	131.1	5
5KP26A	5KP26CA	26.0	28.90	31.90	5	42.1	121.1	5
5KP28A	5KP28CA	28.0	31.10	34.40	5	45.4	112.3	5
5KP30A	5KP30CA	30.0	33.30	36.80	5	48.4	105.4	5
5KP33A	5KP33CA	33.0	36.70	40.60	5	53.3	95.7	5
5KP36A	5KP36CA	36.0	40.00	44.20	5	58.1	87.8	5
5KP40A	5KP40CA	40.0	44.40	49.10	5	64.5	79.1	5
5KP43A	5KP43CA	43.0	47.80	52.80	5	73.5	73.5	5
5KP45A	5KP45CA	45.0	50.00	55.30	5	72.7	70.2	5
5KP48A	5KP48CA	48.0	53.30	58.90	5	77.4	65.9	5
5KP51A	5KP51CA	51.0	56.70	62.70	5	82.4	61.9	5
5KP54A	5KP54CA	54.0	60.00	66.30	5	87.1	58.6	5
5KP58A	5KP58CA	58.0	64.40	71.20	5	93.6	54.5	5
5KP60A	5KP60CA	60.0	66.70	73.70	5	96.8	52.7	5
5KP64A	5KP64CA	64.0	71.10	78.60	5	103.0	49.5	5
5KP70A	5KP70CA	70.0	77.80	86.00	5	113.0	45.1	5
5KP75A	5KP75CA	75.0	83.30	92.10	5	121.0	42.1	5
5KP78A	5KP78CA	78.0	86.70	95.80	5	126.0	40.5	5
5KP85A	5KP85CA	85.0	94.40	104.00	5	137.0	37.2	5
5KP90A	5KP90CA	90.0	100.00	111.00	5	146.0	34.9	5
5KP100A	5KP100CA	100.0	111.00	123.00	5	162.0	31.5	5
5KP110A	5KP110CA	110.0	122.00	135.00	5	177.0	28.8	5
5KP120A	5KP120CA	120.0	133.00	147.00	5	193.0	26.4	5
5KP130A	5KP130CA	130.0	144.00	159.00	5	209.0	24.4	5
5KP150A	5KP150CA	150.0	167.00	185.00	5	243.0	21.0	5
5KP160A	5KP160CA	160.0	178.00	197.00	5	259.0	19.7	5
5KP170A	5KP170CA	170.0	189.00	209.00	5	275.0	18.5	5
5KP180A	5KP180CA	180.0	200.00	221.00	5	292.0	17.5	5
5KP190A	5KP190CA	190.0	211.00	233.00	5	310.0	16.5	5

For bidirectional type having  $V_R$  of 10 volts and less, the  $I_R$  limit is double.  
 For parts without A, the  $V_{BR}$  is  $\pm 10\%$  and  $V_C$  is 5% higher than with A parts

# Transient Voltage Suppressors - 5KP Series

## Ratings and Characteristic Curves

Figure 1 - Peak Pulse Power Rating Curve

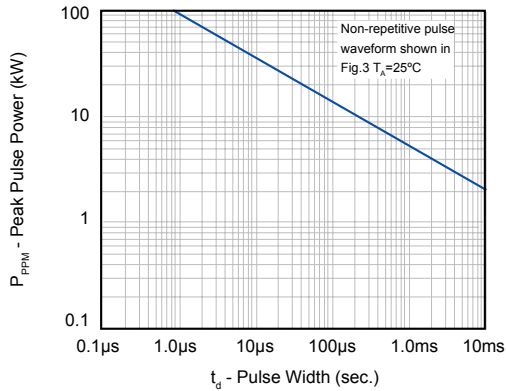

Figure 2 - Pulse Derating Curve

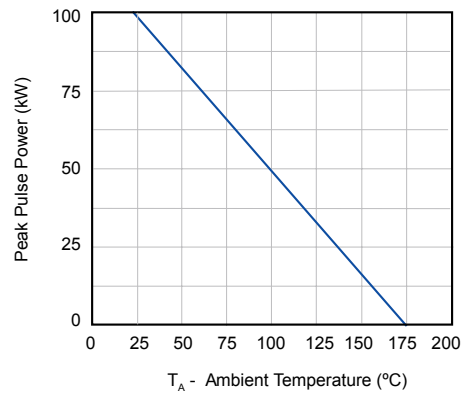

Figure 3 - Pulse Waveform

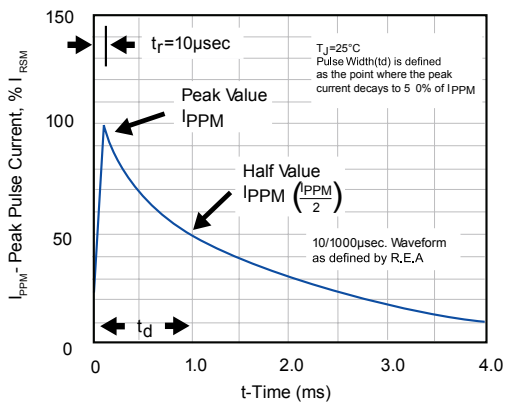

Figure 4 - Typical Junction Capacitance

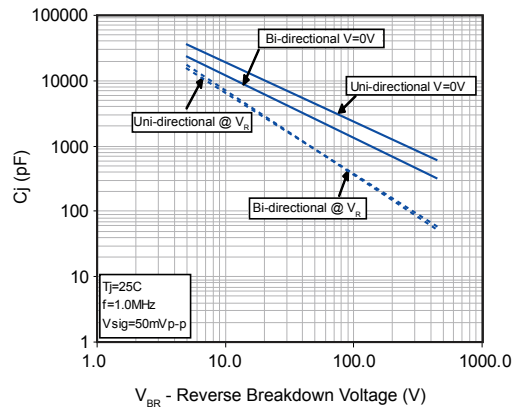

Figure 5 - Steady State Power Derating Curve

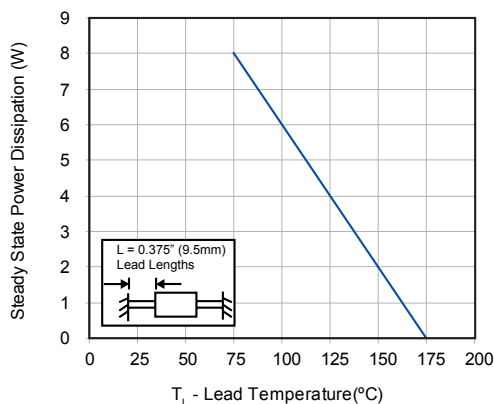
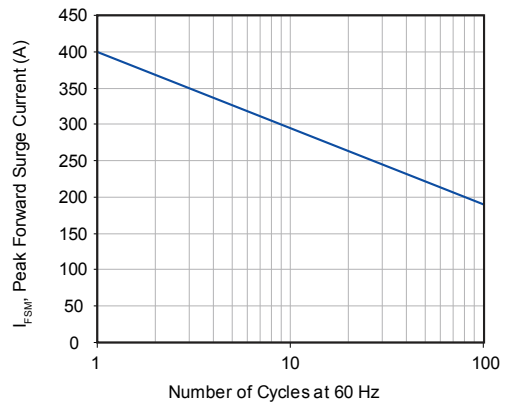

Figure 6 - Maximum Non-Repetitive Peak Forward Surge Current



# Transient Voltage Suppressors - 5KP Series

## Soldering Parameters

	Reflow Condition	Lead-free assembly
Pre Heat	- Temperature Min ( $T_{s(min)}$ )	150°C
	- Temperature Max ( $T_{s(max)}$ )	200°C
	- Time (min to max) ( $t_s$ )	60-180 secs
Average ramp up rate (Liquidus Temp ( $T_L$ ) to peak)		3°C/second max
$T_{s(max)}$ to $T_L$ - Ramp-up Rate		3°C/second max
Reflow	- Temperature ( $T_L$ ) (Liquidus)	217°C
	- Time (min to max) ( $t_s$ )	60-150 seconds
Peak Temperature ( $T_P$ )		260 <sup>+0/-5</sup> °C
Time within 5°C of actual peak Temperature ( $t_p$ )		20-40 seconds
Ramp-down Rate		6°C/second max
Time 25°C to peak Temperature ( $T_P$ )		8 minutes Max.
Do not exceed		280°C

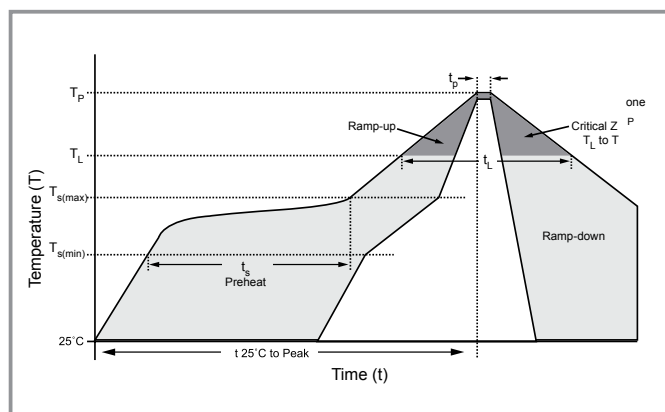

## Physical Specifications

Weight	0.045oz., 1.2g
Case	JEDEC DO-201 molded plastic body over passivated junction.
Polarity	Color band denotes the cathode except Bipolar.
Termina	Matte Tin axial leads, solderable per JESD22-B102D.

## Environmental Specifications

Temperature Cycle	JESD22-A104
Pressure Cooker	JESD 22-A102
High Temp. Storage	JESD22-A103
HTRB	JESD22-A108
Thermal Shock	JESD22-A106

## Flow/Wave Soldering

Peak Temperature :	265°C
Dipping Time :	10 seconds
Soldering :	1 time

# Transient Voltage Suppressors - 5KP Series

## Dimensions

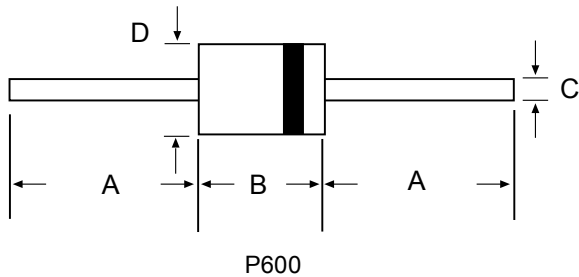

Unit:mm

DIM	Inches		Millimeters	
	Min	Max	Min	Max
A	1.000	-	25.40	-
B	0.340	0.360	8.60	9.10
C	0.048	0.052	1.22	1.32
D	0.340	0.360	8.60	9.10

## Part Numbering System

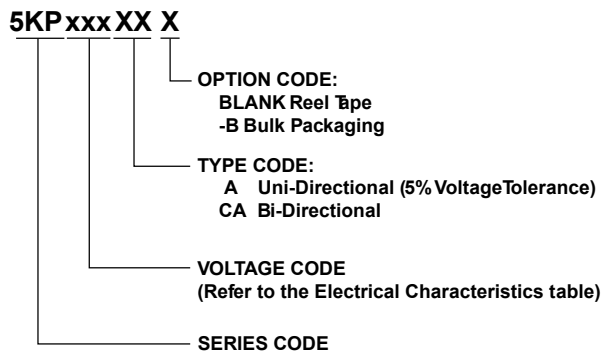

## Packaging

Part Number	Component Package	Quantity	Packaging Option	Packaging Specification
5KPxxxXX	P600	400	Tape & Reel	ELA STD RS-296E
5KPxxxXX-B	P600	100	BULK	Concord Packing Spec

## Warehouse Storage Conditions of Products

- Storage Conditions:
  1. Storage Temperature: -10°C~+40°C
  2. Relative Humidity: ≤75%RH
  3. Keep away from corrosive atmosphere and sunlight.
- Period of Storage: 1 year