

MAPX	MODIFICATION	DATE

NOTES:

- 1. HOUSING: SEE NOTES,
- TERMINAL: SEE NOTES.
- SHELL: SEE NOTES.

SPECIFICATION:

- 1. ELECTRICAL CHARACTERISTIC:
 - CONTACT RESISTANCE: 30MΩ MAX
 - DIELECTRIC WITHSTANDING VOLTAGE: 500V AC FOR 1MIN
 - INSULATION RESISTANCE: 1000MΩ MIN
- 2. MECHANICAL CHARACTERISTIC:
 - INSERTION FORCE: 35N(3.57KGF) MAX
 - EXTRACTION FORCE: 10~35N(1.02~3.57KGF)MIN
 - DURABILITY: 1500 CYCLES EXTRACTION FORCE:10~35N
5000 CYCLES MIN
 - 5000 CYCLES EXTRACTION FORCE:3~35N
- 3. ENVIRONMENTAL:
 - OPERATING TEMPERATURE: -55°C+85°C
- 4. Contact finish:
 - 01:Selective Gold Flash
 - 02:Selective Gold 3U"
 - 03:Selective Gold 5U"
 - 04:Selective Gold 15U"
 - 05:Selective Gold 30U"

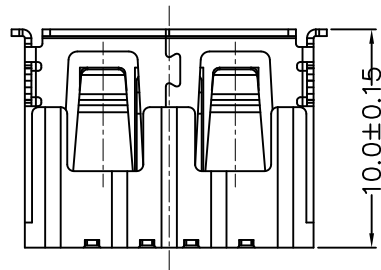
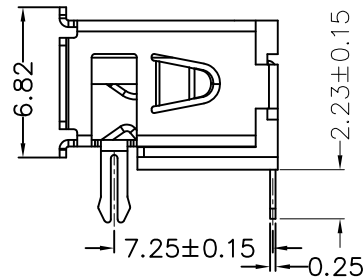
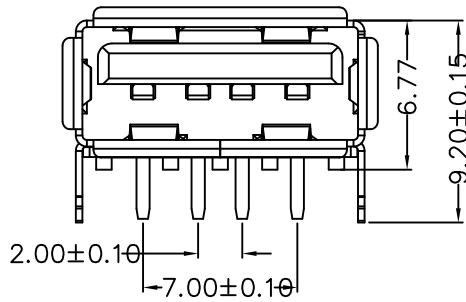
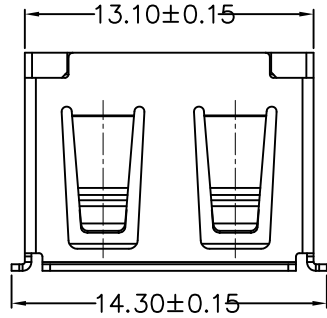

产品图 PRODUCT CHART DWG											
公差一览表 TOLERANCE UNLESS OTHERWISE				单位 UNITS	MM	制图 DRAWING	Z-Y-B	制图料号 PRODUCT PART NO.			
X.	±0.25	X.	±5°	比例 SCALE	1:1	审核 CHKD		产品名称 PRODUCT NO.	C42504		
.X	±0.20	.X	±2°	日期 DATE	2012.10.15	核准 APPD		角法 VIEW		版本 VER	A0
.XX	±0.15	.XX	±1°								
.XXX	±0.10	.XXX	±0.5°								