

MAPX	MODIFICATION	DATE

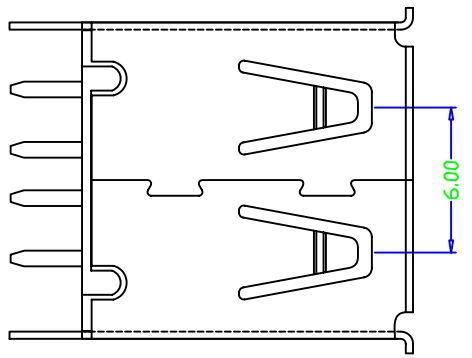
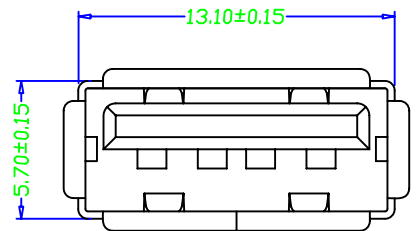
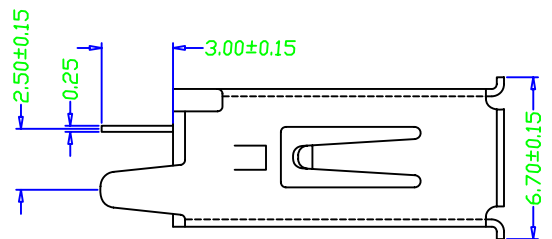
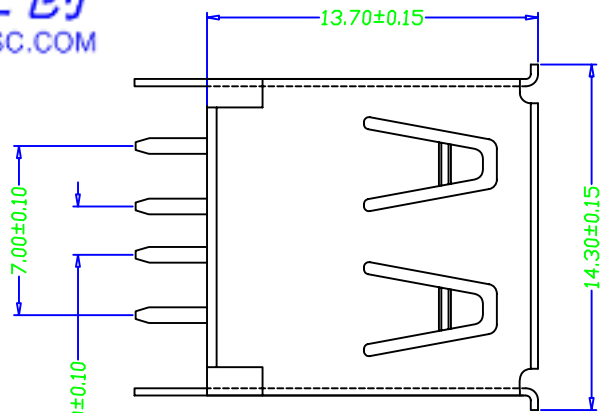

NOTES:

- 1. HOUSING: SEE NOTES, UL94V-0 .
- TERMINAL: SEE NOTES.
- SHELL: SEE NOTES.

SPECIFICATION:

- 1. ELECTRICAL CHARACTERISTIC:
 - CONTACT RESISTANCE: 30MΩ MAX
 - DIELECTRIC WITHSTANDING VOLTAGE: 500V AC FOR 1MIN
 - INSULATION RESISTANCE: 1000MΩ MIN
- 2. MECHANICAL CHARACTERISTIC:
 - INSERTION FORCE: 35N(3.57KGF) MAX
 - EXTRACTION FORCE: 10~35N(1.02~3.57KGF)MIN
 - DURABILITY: 1500 CYCLES EXTRACTION FORCE:10~35N
5000 CYCLES MIN
5000 CYCLES EXTRACTION FORCE:3~35N

3. ENVIRONMENTAL:

OPERATING TEMPERATURE: -55°C+85°C

4. Contact finish:

- 01:Selective Gold Flash
- 02:Selective Gold 3U"
- 03:Selective Gold 5U"
- 04:Selective Gold 15U"
- 05:Selective Gold 30U"

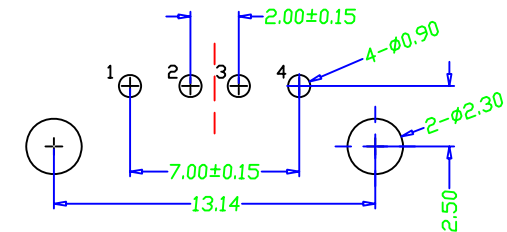

PCB LAYOUT

<p>产品图 PRODUCT CHART DWG</p>										
<p>公差一览表 TOLERANCE UNLESS OTHERWISE</p>				单位 UNITS	MM	制图 DRAWING	Z-Y-B	制图料号 PRODUCT PART NO.		
X.	±0.25	X.	±5.°	比例 SCALE	1:1	审核 CHKD		产品名称 PRODUCT NAME	USB A/F 180度插板式有边 (13.7)	
.X	±0.20	.X	±2.°	日期 DATE	2014.07.24	核准 APPD		角法 VIEW	版本 VER	AD
.XX	±0.15	.XX	±1.°							
.XXX	±0.10	.XXX	±0.5°							