

# Multilayer Chip Ferrite Bead – PZ Series

Operating Temp. : -55°C~+125°C

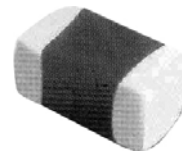

## FEATURES

- Internal silver printed layers and magnetic shielded structures to minimize crosstalk
- Large withstand current (allowable current: up to 6A)
- Can be used in a wide range of frequency to suppress EMI
- Three types material and wide range of impedance values for various applications

## APPLICATIONS

- Noise suppression for power line or large current signal of electric equipments such as computers and peripheral devices, DVD cameras, LCD TVs, communication equipments, OA equipments, etc.

## PRODUCT IDENTIFICATION

<b>PZ</b> ①	<b>1608</b> ②	<b>U</b> ③	<b>121</b> ④	<b>-2R0</b> ⑤	<b>T</b> ⑥	<b>F</b> ⑦																				
<table border="1"> <tr><th colspan="2">Type</th></tr> <tr><td>PZ</td><td>Chip Ferrite Bead For Large Current</td></tr> </table>		Type		PZ	Chip Ferrite Bead For Large Current	<table border="1"> <tr><th colspan="2">External Dimensions (L×W) (mm)</th></tr> <tr><td>1005 [0402]</td><td>1.0×0.5</td></tr> <tr><td>1608 [0603]</td><td>1.6×0.8</td></tr> <tr><td>2012 [0805]</td><td>2.0×1.25</td></tr> <tr><td>3216 [1206]</td><td>3.2×1.6</td></tr> <tr><td>4516 [1806]</td><td>4.5×1.6</td></tr> </table>		External Dimensions (L×W) (mm)		1005 [0402]	1.0×0.5	1608 [0603]	1.6×0.8	2012 [0805]	2.0×1.25	3216 [1206]	3.2×1.6	4516 [1806]	4.5×1.6	<table border="1"> <tr><th colspan="2">Material Code</th></tr> <tr><td colspan="2">D, E, U</td></tr> </table>		Material Code		D, E, U		
Type																										
PZ	Chip Ferrite Bead For Large Current																									
External Dimensions (L×W) (mm)																										
1005 [0402]	1.0×0.5																									
1608 [0603]	1.6×0.8																									
2012 [0805]	2.0×1.25																									
3216 [1206]	3.2×1.6																									
4516 [1806]	4.5×1.6																									
Material Code																										
D, E, U																										
				<table border="1"> <tr><th colspan="2">Rated Current</th></tr> <tr><td>1R0</td><td>1.0A</td></tr> <tr><td>2R5</td><td>2.5A</td></tr> <tr><td>R60</td><td>0.6A</td></tr> </table>		Rated Current		1R0	1.0A	2R5	2.5A	R60	0.6A													
Rated Current																										
1R0	1.0A																									
2R5	2.5A																									
R60	0.6A																									
<table border="1"> <tr><th colspan="2">Nominal Impedance</th></tr> <tr><th>Example</th><th>Nominal Value</th></tr> <tr><td>300</td><td>30Ω</td></tr> <tr><td>121</td><td>120Ω</td></tr> <tr><td>102</td><td>1000Ω</td></tr> </table>		Nominal Impedance		Example	Nominal Value	300	30Ω	121	120Ω	102	1000Ω	<table border="1"> <tr><th colspan="2">Packing</th></tr> <tr><td>T</td><td>Tape &amp; Reel</td></tr> </table>		Packing		T	Tape & Reel	<table border="1"> <tr><th colspan="2">Hazardous Substance Free Products</th></tr> <tr><td colspan="2">F</td></tr> </table>		Hazardous Substance Free Products		F				
Nominal Impedance																										
Example	Nominal Value																									
300	30Ω																									
121	120Ω																									
102	1000Ω																									
Packing																										
T	Tape & Reel																									
Hazardous Substance Free Products																										
F																										

## SHAPE AND DIMENSIONS

Unit: mm [inch]

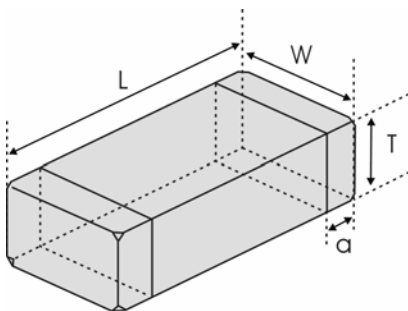

Type	L	W	T	a
PZ1005 [0402]	1.0±0.15 [.039±.006]	0.5±0.15 [.020±.006]	0.5±0.15 [.020±.006]	0.25±0.1 [.010±.004]
PZ1608 [0603]	1.6±0.15 [.063±.006]	0.8±0.15 [.031±.006]	0.8±0.15 [.031±.006]	0.3±0.2 [.012±.008]
PZ2012 [0805]	2.0 (+0.3, -0.1) [.079 (+.012, -.004)]	1.25±0.2 [.049±.008]	0.85±0.2 [.033±.008]	0.5±0.3 [.020±.012]
PZ3216 [1206]	3.2±0.2 [.126±.008]	1.6±0.2 [.063±.008]	0.85±0.2 [.033±.008]	0.5±0.3 [.020±.012]
			1.1±0.2 [.043±.008]	
PZ4516 [1806]	4.5±0.2 [.178±.008]	1.6±0.2 [.063±.008]	1.6±0.2 [.063±.008]	0.5±0.3 [.020±.012]

## SPECIFICATIONS

### PZ1005 TYPE

Part Number	Impedance	Z Test Frequency	Max.DC Resistance	Max.Rated Current	Thickness
Units	$\Omega$	MHz	$\Omega$	mA	mm [inch]
Symbol	Z	Freq.	DCR	I <sub>r</sub>	T
PZ1005D100-1R0TF	0~30	100	0.05	1000	0.5±0.15 [.020±.006]
PZ1005E100-1R8TF	0~15	100	0.02	1800	
PZ1005E700-R80TF	70±25%	100	0.10	800	
PZ1005E121-R70TF	120±25%	100	0.13	700	
PZ1005E221-R60TF	220±25%	100	0.18	600	
PZ1005E601-R45TF	600±25%	100	0.34	450	
PZ1005U700-1R2TF	70±25%	100	0.10	1200	
PZ1005U121-1R0TF	120±25%	100	0.12	1000	
PZ1005U221-R80TF	220±25%	100	0.18	800	
PZ1005U601-R45TF	600±25%	100	0.34	450	

### PZ1608 TYPE

Part Number	Impedance	Z Test Frequency	Max. DC Resistance	Max. Rated Current	Thickness
Units	$\Omega$	MHz	$\Omega$	mA	mm [inch]
Symbol	Z	Freq.	DCR	I <sub>r</sub>	T
PZ1608D300-3R0TF	30±25%	100	0.03	3000	0.8±0.15 [.031±.006]
PZ1608D600-2R0TF	60±25%	100	0.08	2000	
PZ1608D750-1R0TF	75±25%	100	0.15	1000	
PZ1608D121-1R0TF	120±25%	100	0.20	1000	
PZ1608D221-1R0TF	220±25%	100	0.20	1000	
PZ1608D601-R50TF	600±25%	100	0.35	500	
PZ1608E600-1R4TF	60±25%	100	0.10	1400	
PZ1608U100-3R0TF	0~15	100	0.02	3000	
PZ1608U300-3R0TF	30±25%	100	0.03	3000	
PZ1608U600-2R5TF	60±25%	100	0.04	2500	
PZ1608U121-2R0TF	120±25%	100	0.05	2000	
PZ1608U221-1R4TF	220±25%	100	0.10	1400	
PZ1608U331-1R2TF	330±25%	100	0.14	1200	
PZ1608U391-1R0TF	390±25%	100	0.14	1000	
PZ1608U471-1R0TF	470±25%	100	0.20	1000	

### PZ2012 TYPE

Part Number	Impedance	Z Test Frequency	Max. DC Resistance	Max. Rated Current	Thickness
Units	$\Omega$	MHz	$\Omega$	mA	mm [inch]
Symbol	Z	Freq.	DCR	I <sub>r</sub>	T
PZ2012D390-4R0TF	39±25%	100	0.02	4000	0.85±0.2 [.033±.008]
PZ2012D800-3R0TF	80±25%	100	0.04	3000	
PZ2012D121-2R5TF	120±25%	100	0.06	2500	
PZ2012D221-1R5TF	220±25%	100	0.08	1500	
PZ2012D301-1R5TF	300±25%	100	0.12	1500	
PZ2012D471-R80TF	470±25%	100	0.25	800	
PZ2012D601-R80TF	600±25%	100	0.25	800	
PZ2012U300-3R0TF	30±25%	100	0.02	3000	
PZ2012U300-4R0TF	30±25%	100	0.015	4000	
PZ2012U600-3R0TF	60±25%	100	0.025	3000	
PZ2012U121-2R5TF	120±25%	100	0.04	2500	
PZ2012U221-2R0TF	220±25%	100	0.07	2000	
PZ2012U301-1R5TF	300±25%	100	0.10	1500	
PZ2012U421-1R0TF	420±25%	100	0.20	1000	
PZ2012U601-R80TF	600±25%	100	0.25	800	

## SPECIFICATIONS

### PZ3216 TYPE

Part Number	Impedance	Z Test Frequency	Max. DC Resistance	Max. Rated Current	Thickness
Units	$\Omega$	MHz	$\Omega$	mA	mm [inch]
Symbol	Z	Freq.	DCR	I <sub>r</sub>	T
PZ3216D190-6R0TF	19±25%	100	0.010	6000	0.85±0.2 [.033±.008]
PZ3216D380-5R0TF	38±25%	100	0.015	5000	
PZ3216D600-4R0TF	60±25%	100	0.02	4000	
PZ3216D121-3R0TF	120±25%	100	0.03	3000	
PZ3216D501-2R0TF	500±25%	100	0.07	2000	
PZ3216D601-2R0TF	600±25%	100	0.07	2000	
PZ3216U300-6R0TF	30±25%	100	0.01	6000	
PZ3216U600-4R0TF	60±25%	100	0.025	4000	
PZ3216U121-3R0TF	120±25%	100	0.03	3000	
PZ3216U221-2R0TF	220±25%	100	0.08	2000	
PZ3216U301-2R0TF	300±25%	100	0.10	2000	
PZ3216U391-2R0TF	390±25%	100	0.07	2000	
PZ3216U601-1R5TF	600±25%	100	0.10	1500	
PZ3216U102-R50TF	1000±25%	100	0.30	500	

Note: The thickness of PZ3216 series may be increased to 1.1±0.2 mm when the I<sub>r</sub> of product increased.

### PZ4516 TYPE

Part Number	Impedance	Z Test Frequency	Max. DC Resistance	Max. Rated Current	Thickness
Units	$\Omega$	MHz	$\Omega$	mA	mm [inch]
Symbol	Z	Freq.	DCR	I <sub>r</sub>	T
PZ4516U600-6R0TF	60±25%	100	0.01	6000	1.6±0.2 [.063±.008]
PZ4516U720-6R0TF	72±25%	100	0.01	6000	
PZ4516U181-3R0TF	180±25%	100	0.025	3000	
PZ4516U471-2R0TF	470±25%	100	0.05	2000	

※: Products with other electrical characteristics can be provided upon customer's request. Please contact your local sales.

## TYPICAL ELECTRICAL CHARACTERISTICS

### D, E, U Material Comparison

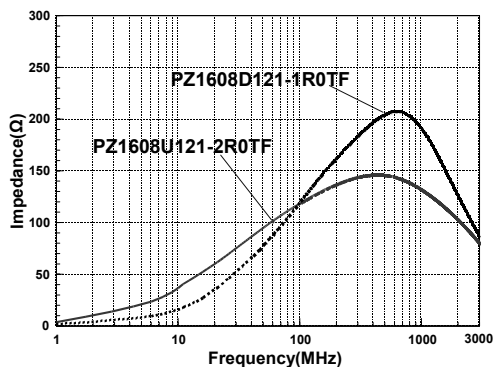

### Rated Current

When operating temperatures exceed +85°C, derating of current is necessary for chip ferrite beads for which rated current is 1000mA and over. Please apply the derating curve shown in chart according to the operating temperature.

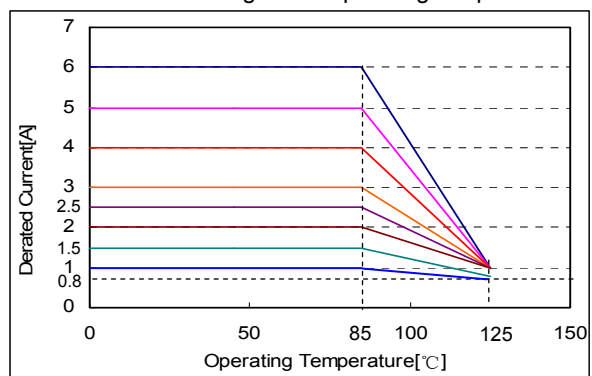

# DETAIL ELECTRICAL CHARACTERISTICS

## PZ1005 TYPE

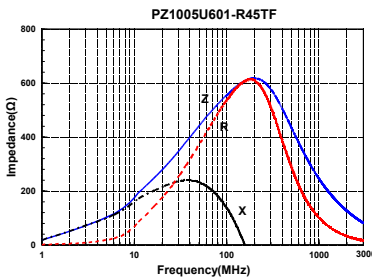
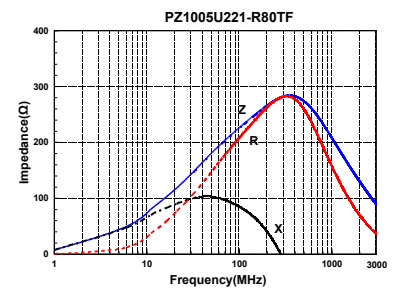
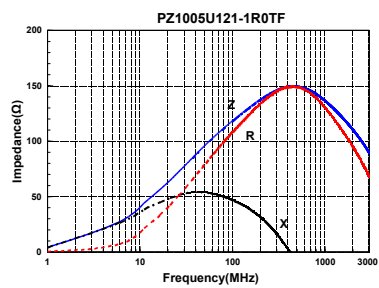
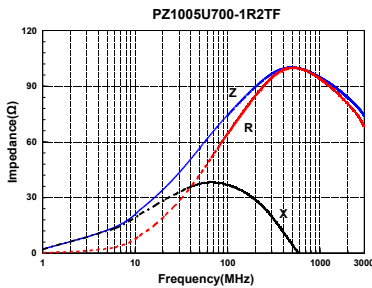
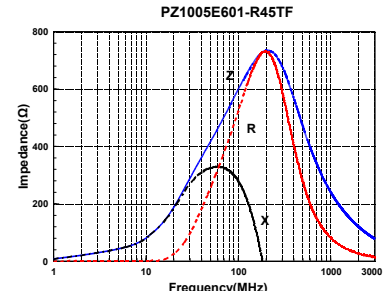
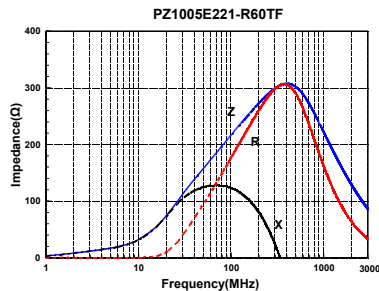
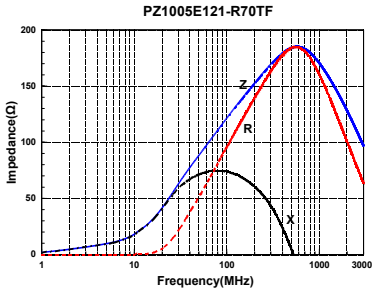
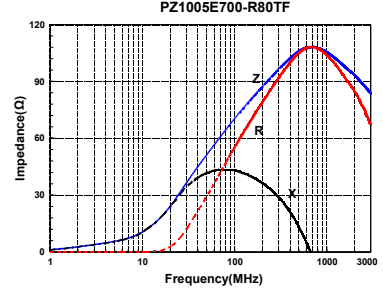
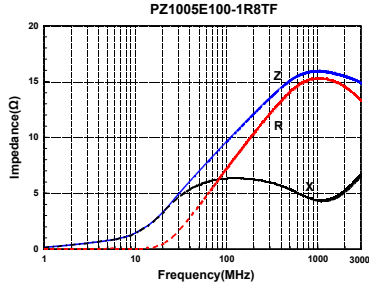
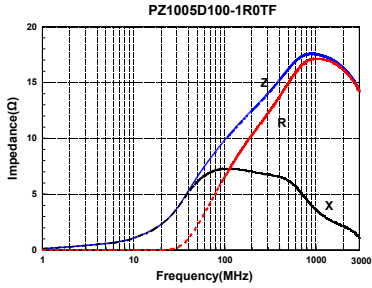

## PZ1608 TYPE

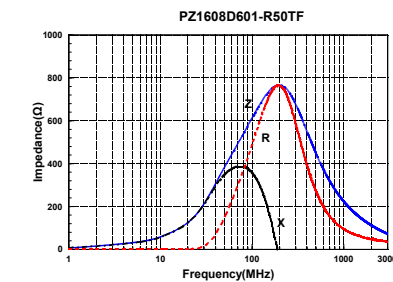
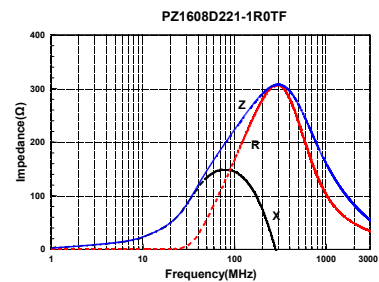
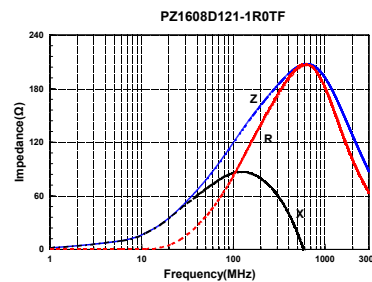
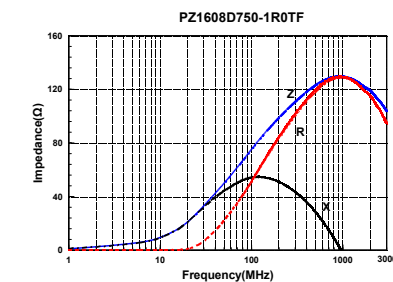
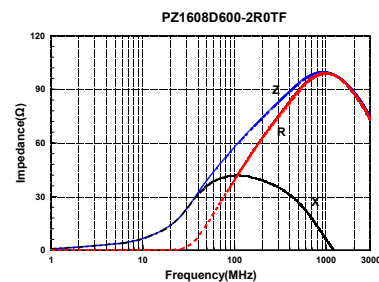
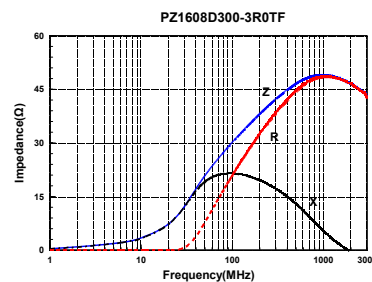

**Sunlord**

Specifications subject to change without notice. Please check our website for latest information. Revised 2014/04/15

Sunlord Industrial Park, Dafuyuan Industrial Zone, Guanlan, Shenzhen, China 518110 Tel: 0086-755-29832660 Fax: 0086-755-82269029 E-Mail: sunlord@sunlordinc.com

# DETAIL ELECTRICAL CHARACTERISTICS

## PZ1608 TYPE

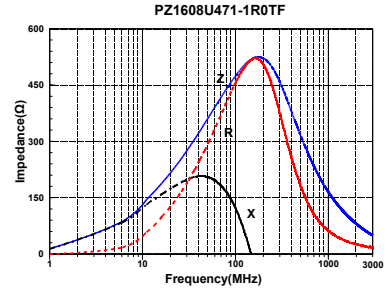
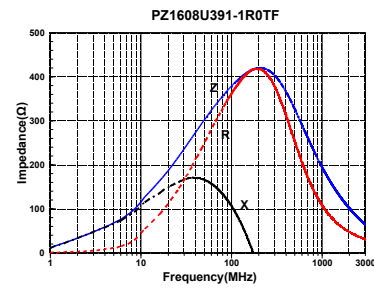
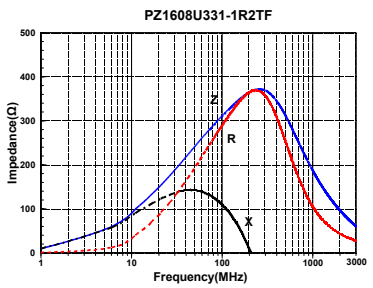
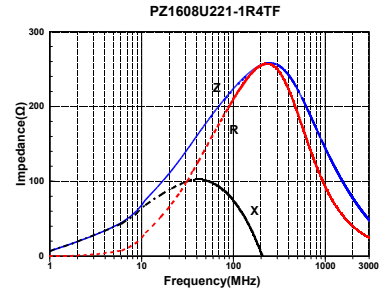
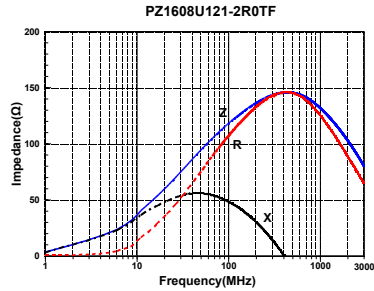
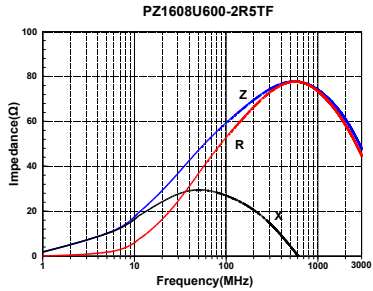
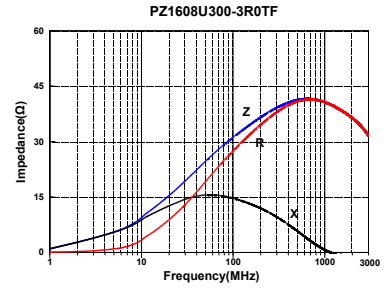
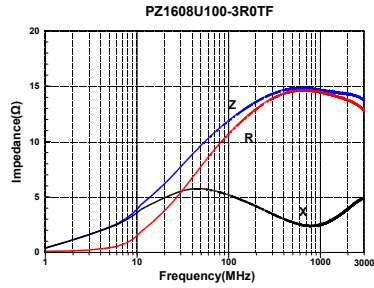
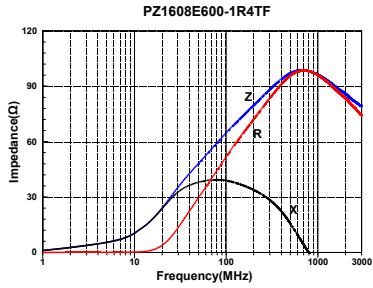

## PZ2012 TYPE

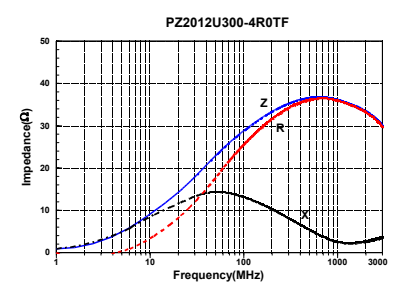
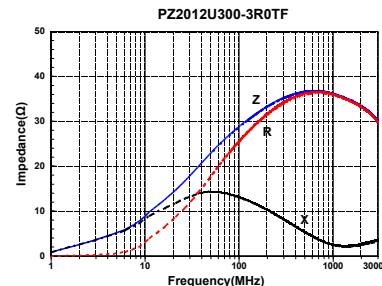
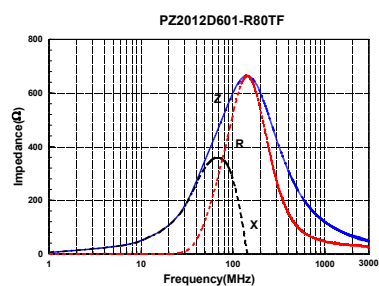
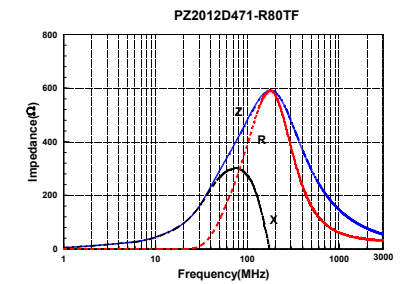
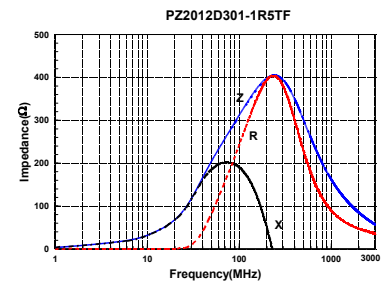
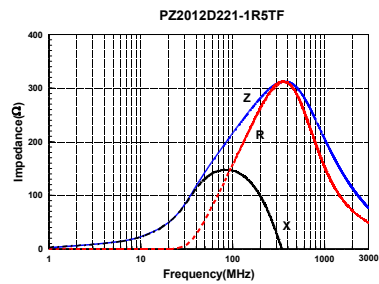
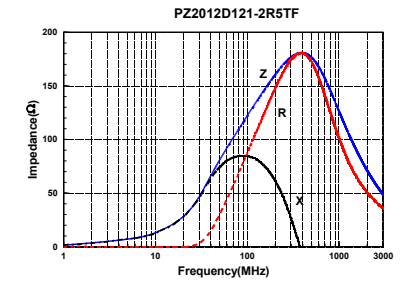
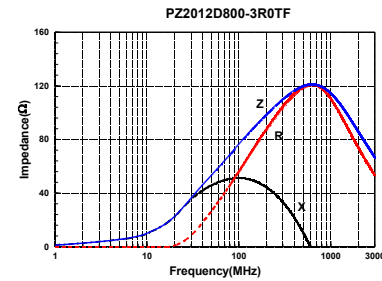
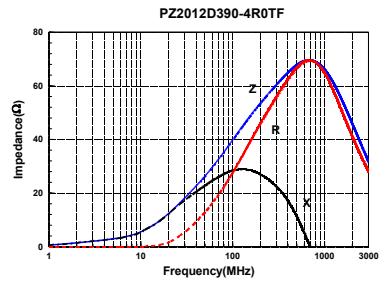

Specifications subject to change without notice. Please check our website for latest information. Revised 2014/04/15

Sunlord Industrial Park, Dafuyuan Industrial Zone, Guanlan, Shenzhen, China 518110 Tel: 0086-755-29832660 Fax: 0086-755-82269029 E-Mail: sunlord@sunlordinc.com

# DETAIL ELECTRICAL CHARACTERISTICS

## PZ2012 TYPE

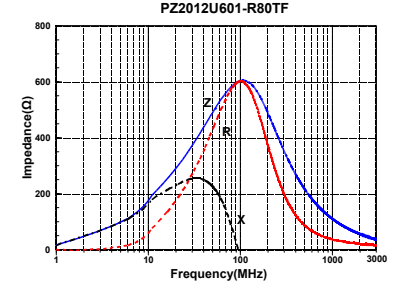
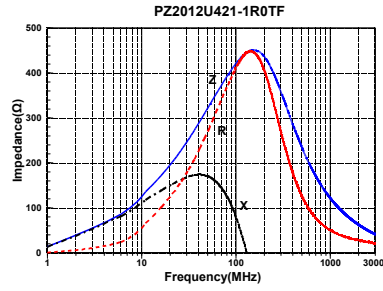
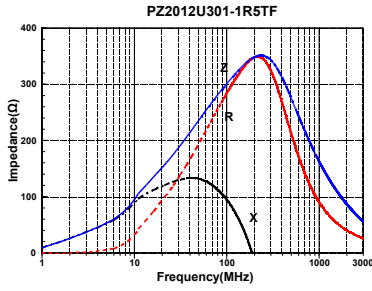
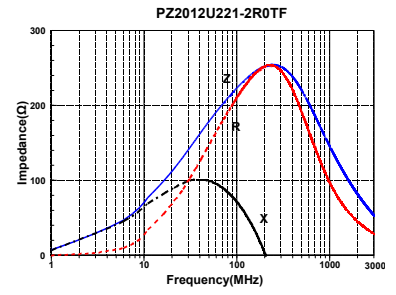
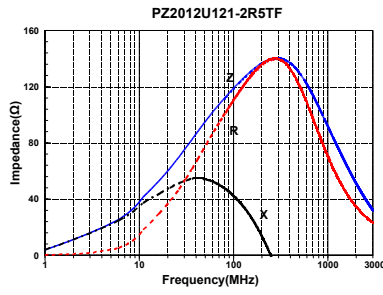
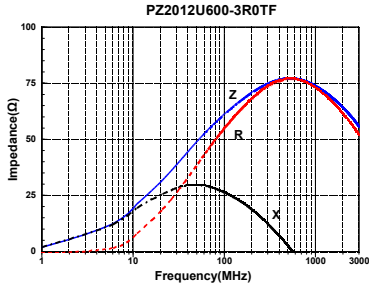

## PZ3216 TYPE

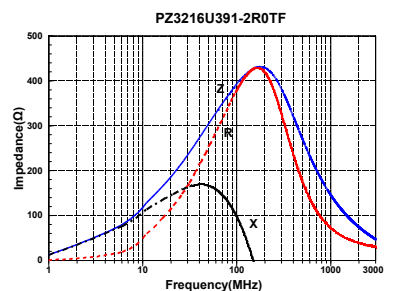
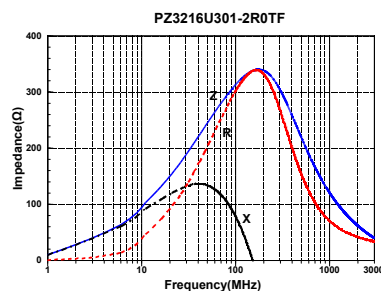
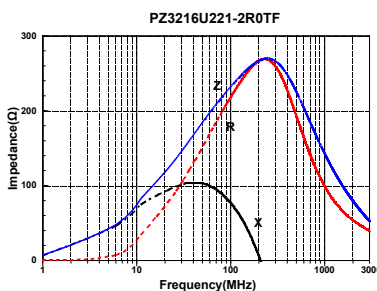
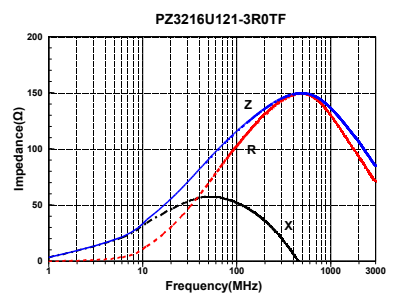
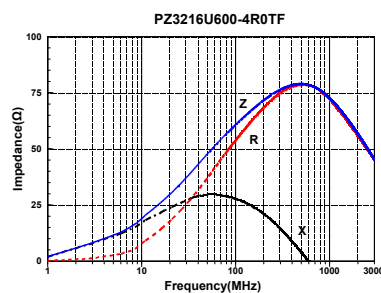
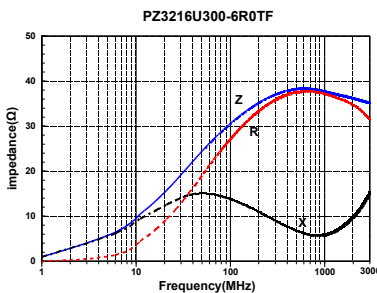
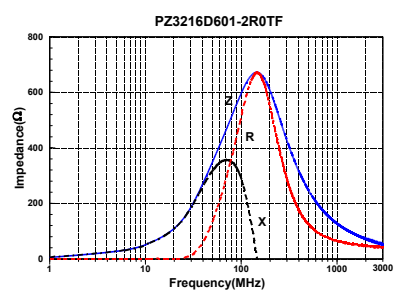
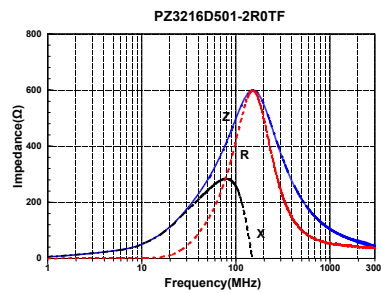
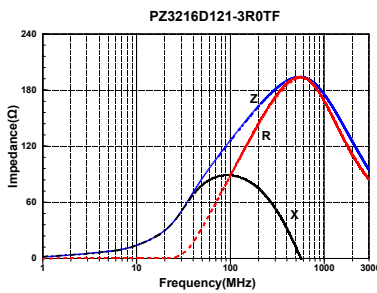
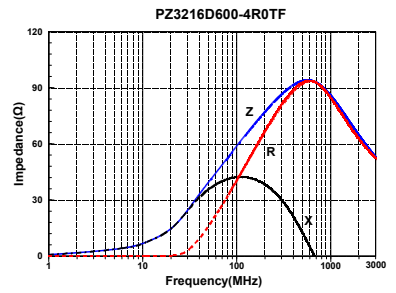
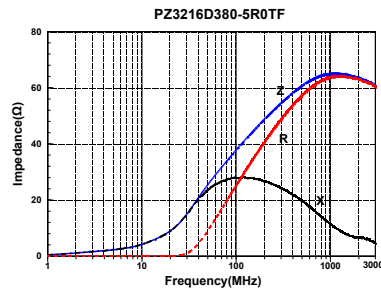
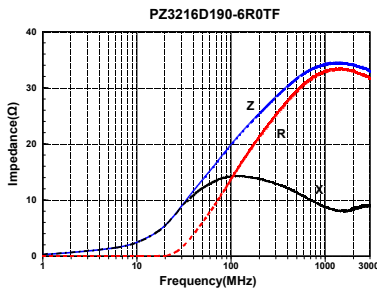

Specifications subject to change without notice. Please check our website for latest information. Revised 2014/04/15

Sunlord Industrial Park, Dafuyuan Industrial Zone, Guanlan, Shenzhen, China 518110 Tel: 0086-755-29832660 Fax: 0086-755-82269029 E-Mail: sunlord@sunlordinc.com

# DETAIL ELECTRICAL CHARACTERISTICS

## PZ3216 TYPE

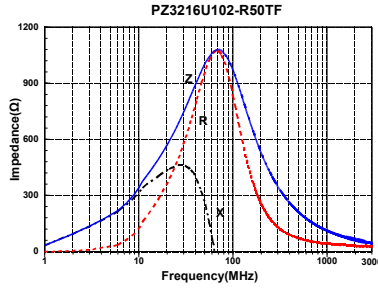
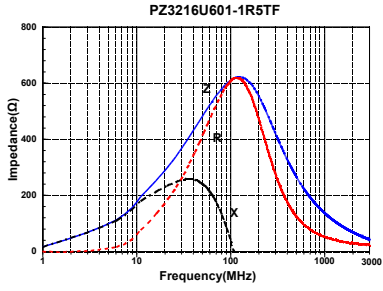

## PZ4516 TYPE

