

TO-92 Plastic-Encapsulate Transistors

2SA1020 TRANSISTOR (PNP)

FEATURES

- Power Amplifier Applications

MAXIMUM RATINGS (T_a=25°C unless otherwise noted)

Symbol	Parameter	Value	Unit
V _{CB0}	Collector-Base Voltage	-50	V
V _{CEO}	Collector-Emitter Voltage	-50	V
V _{EBO}	Emitter-Base Voltage	-5	V
I _C	Collector Current –Continuous	-2	A
P _C	Collector Power Dissipation	625	mW
T _J	Junction Temperature	150	°C
T _{stg}	Storage Temperature	-55-150	°C

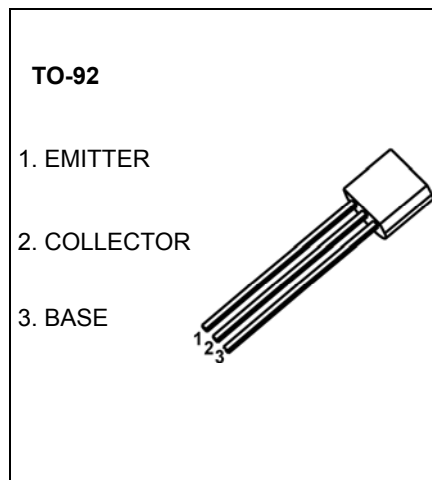

ELECTRICAL CHARACTERISTICS (T_a=25°C unless otherwise specified)

Parameter	Symbol	Test conditions	Min	Typ	Max	Unit
Collector-base breakdown voltage	V _{(BR)CBO}	I _C = -100μA, I _E = 0	-50			V
Collector-emitter breakdown voltage	V _{(BR)CEO}	I _C = -10mA, I _B = 0	-50			V
Emitter-base breakdown voltage	V _{(BR)EBO}	I _E = -100μA, I _C = 0	-5			V
Collector cut-off current	I _{CBO}	V _{CB} = -50V, I _E = 0			-1	μA
Emitter cut-off current	I _{EBO}	V _{EB} = -5V, I _C = 0			-1	μA
DC current gain	h _{FE(1)}	V _{CE} = -2V, I _C = -0.5A	70		240	
	h _{FE(2)}	V _{CE} = -2V, I _C = -1.5A	40			
Collector-emitter saturation voltage	V _{CE(sat)}	I _C = -1A, I _B = -50mA			-0.5	V
Base-emitter saturation voltage	V _{BE(sat)}	I _C = -1A, I _B = -50mA			-1.2	V
Transition frequency	f _T	V _{CE} = -2V, I _C = -500mA		100		MHz
Collector output capacitance	C _{ob}	V _{CB} = -10V, I _E = 0, f = 1MHz		40		pF

CLASSIFICATION OF h_{FE(1)}

Rank	O	Y
Range	70-140	120-240

Typical Characteristics

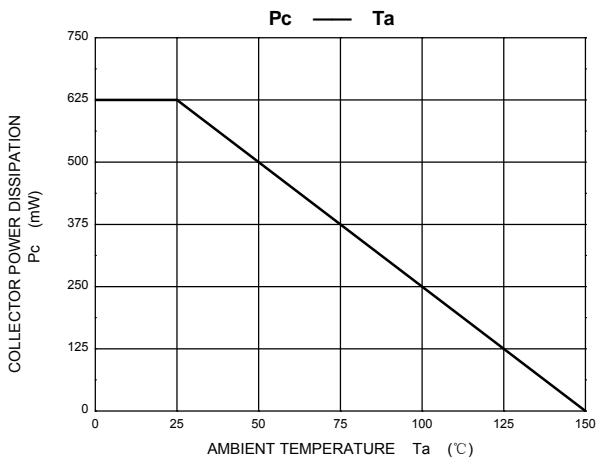
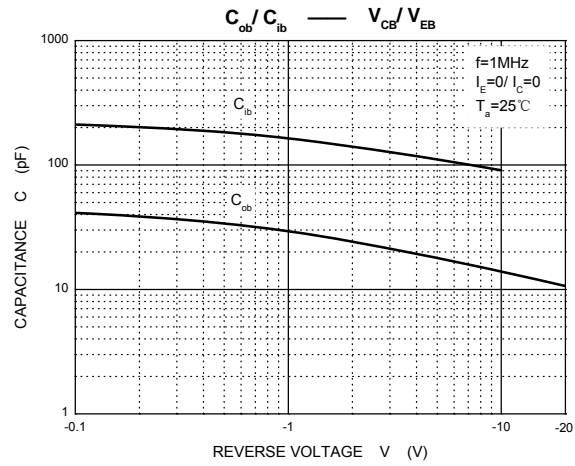
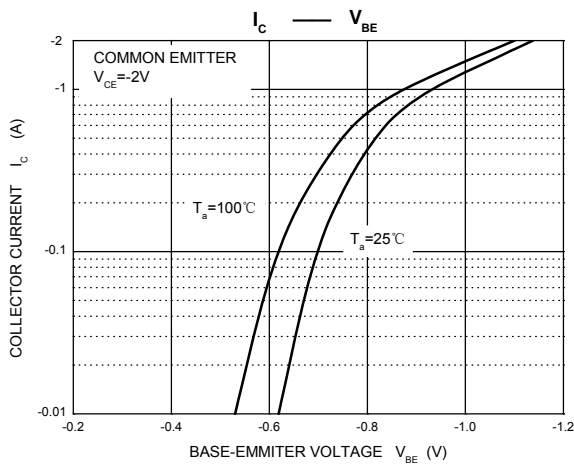
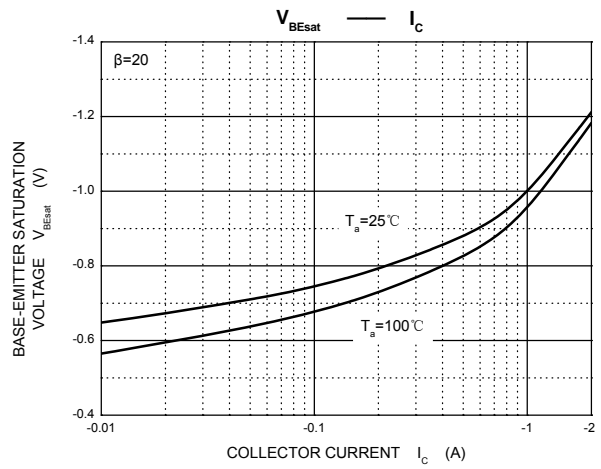
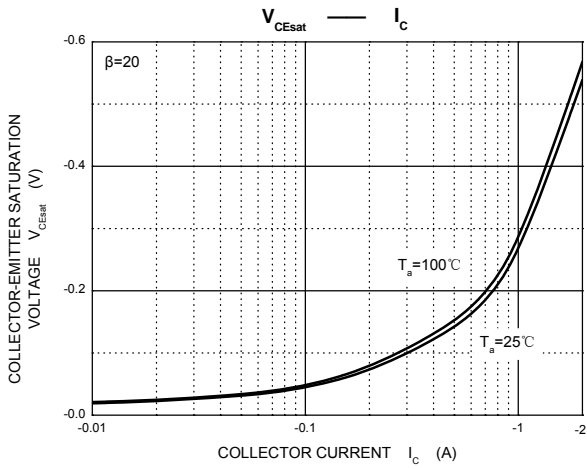
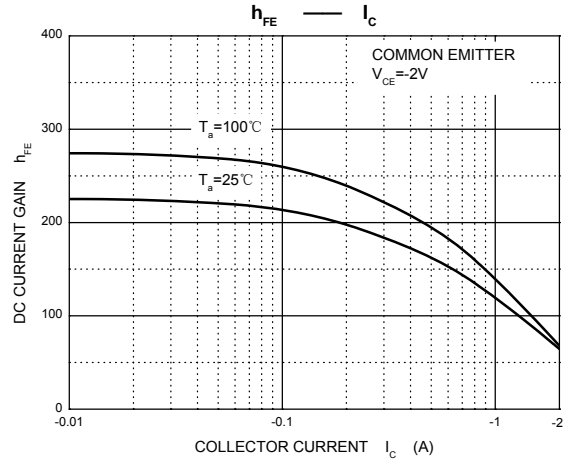
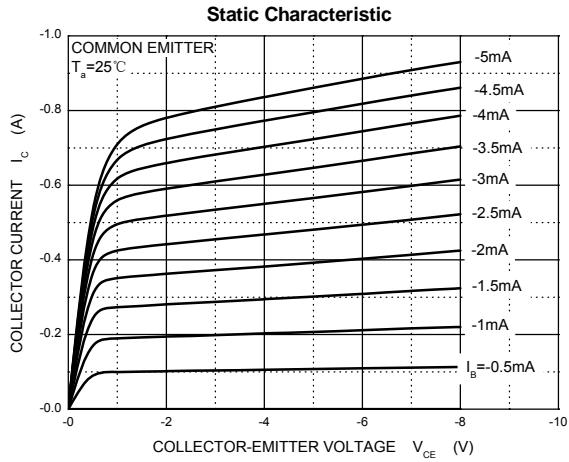

TO-92 Package Outline Dimensions



Symbol	Dimensions In Millimeters		Dimensions In Inches	
	Min	Max	Min	Max
A	3.300	3.700	0.130	0.146
A1	1.100	1.400	0.043	0.055
b	0.380	0.550	0.015	0.022
c	0.360	0.510	0.014	0.020
D	4.300	4.700	0.169	0.185
D1	3.430		0.135	
E	4.300	4.700	0.169	0.185
e	1.270 TYP		0.050 TYP	
e1	2.440	2.640	0.096	0.104
L	14.100	14.500	0.555	0.571
Φ		1.600		0.063
h	0.000	0.380	0.000	0.015

TO-92 Suggested Pad Layout



Note:

1. Controlling dimension: in millimeters.
2. General tolerance: $\pm 0.05\text{mm}$.
3. The pad layout is for reference purposes only.

NOTICE

JCET reserve the right to make modifications, enhancements, improvements, corrections or other changes without further notice to any product herein. JCET does not assume any liability arising out of the application or use of any product described herein.

TO-92 PACKAGE TAPING DIMENSION



Dimensions are in millimeter

A1	A	T	P	P0	P2	F1	F2	W
4.5	4.5	3.5	12.7	12.7	6.35	2.5	2.5	18.0
W0	W1	W2	H	H0	D0	t1	t2	ΔP
6.0	9.0	1.0 MAX.	19.0	16.0	4.0	0.4	0.2	0

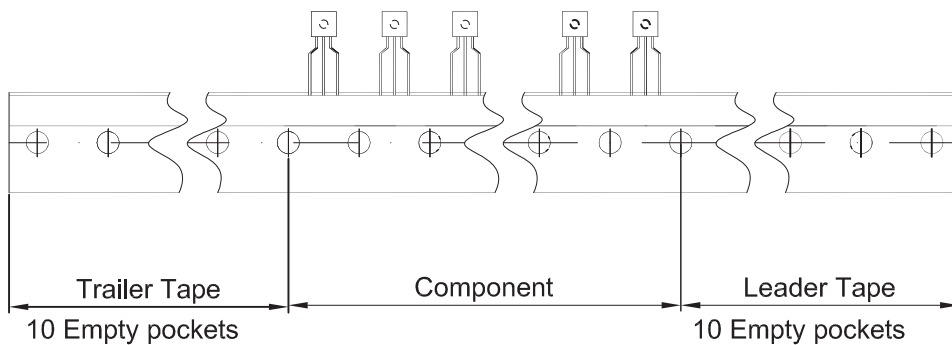

Package	Box	Box Size(mm)	Carton	Carton Size(mm)
TO-92	2000 pcs	333×162×43	20,000 pcs	350×340×250