

SPECIFICATIONS

Customer	
Product Name	Multi-layer Chip Ferrite Bead
Sunlord Part Number	PZ Series
Customer Part Number	

New Released, Revised]

SPEC No.: PZ10130000

【 This SPEC is total 14 pages including specifications and appendix. 】

【 ROHS Compliant Parts 】

Approved By	Checked By	Issued By

Shenzhen Sunlord Electronics Co., Ltd.

Address: Sunlord Industrial Park, Dafuyuan Industrial Zone, Guanlan, Shenzhen, China 518110
 Tel: 0086-755-29832660 Fax: 0086-755-82269029 E-Mail: sunlord@sunlordinc.com

【 For Customer approval Only 】

Date: _____

Qualification Status: Full Restricted Rejected

Approved By	Verified By	Re-checked By	Checked By

Comments:

【Version change history】

Rev.	Effective Date	Changed Contents	Change Reasons	Approved By
01	/	New release	/	Hai Guo

1. Scope

This specification applies to PZ Series of multi-layer ferrite chip bead.

2. Product Description and Identification (Part Number)

1) Description:

Multi-layer ferrite chip beads.

2) Product Identification (Part Number)

PZ _____ ○ XXX -□□□ _ E

Type	
PZ	For Large current

Material Code	
D, E, U	

Rate Current	
R50	0.5A
1R5	1.5A
3R0	3.0A

Packing	
T	Tape Carrier Package

External Dimensions(L X W) [mm]	
1005 [0402]	1.0 X 0.5
1608 [0603]	1.6 X 0.8
2012 [0805]	2.0 X 1.25
3216 [1206]	3.2 X 1.6
4516[1806]	4.5 X 1.6

Nominal Impedance	
Example	Nominal Value
300	30Ω
121	120Ω

HSF Products
Hazardous Substance Free Products

3. Electrical Characteristics

Please refer to **Appendix A** (Page 9~14).

- Operating and storage temperature range (individual chip without packing): -55 ~ +125
- Storage temperature range (packaging conditions): -10 ~+40 and RH 70% (Max.)

4. Shape and Dimensions

- Dimensions and recommended PCB pattern for reflow soldering: See **Fig.4-1**, **Fig.4-2** and **Table 4-1**.
- Structure: See **Fig. 4-3** and **Fig. 4-4**.

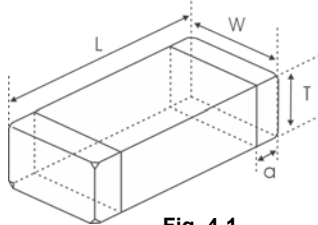

Fig. 4-1

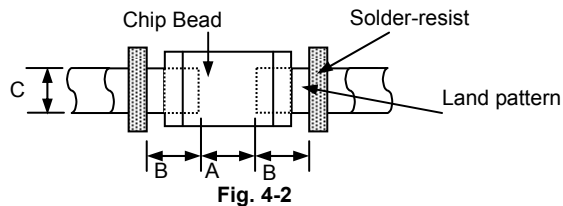

Fig. 4-2

[Table 4-1]

Unit: mm [inch]

Type	L	W	T	a	A	B	C
1005 [0402]	1.0±0.15 [0.039±0.006]	0.5±0.15 [0.020±0.006]	0.5±0.15 [0.020±0.003]	0.25±0.1 [0.010±0.006]	0.45~0.55	0.40~0.50	0.45~0.55
1608 [0603]	1.6±0.15 [0.063±0.006]	0.8±0.15 [0.031±0.006]	0.8±0.15 [0.031±0.006]	0.3±0.2 [0.012±0.008]	0.60~0.80	0.60~0.80	0.60~0.80
2012 [0805]	2.0 (+0.3, -0.1) [0.079(+0.012,-0.004)]	1.25±0.2 [0.049±0.008]	0.85±0.2 [0.033±0.008]	0.5±0.3 [0.020±0.012]	0.80~1.20	0.80~1.20	0.90~1.60
3216 [1206]	3.2±0.2 [0.126±0.008]	1.6±0.2 [0.063±0.008]	0.85±0.2[0.033±0.008]	0.5±0.3 [0.020±0.012]	1.80~2.50	1.00~1.50	1.20~2.00
			1.10±0.2[0.043±0.008]				
4516 [1806]	4.5±0.2 [1.78±.008]	1.6±0.2 [.063±.008]	1.6±0.2 [.063±.008]	0.5±0.3 [0.020±0.012]	2.8~3.2	1.25~1.75	0.9~1.6

Note: The details of different thickness for different products see **Appendix A**: Electrical Characteristics.

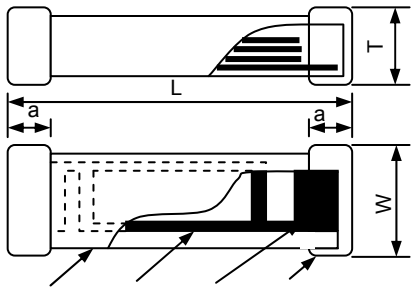

Fig. 4-3

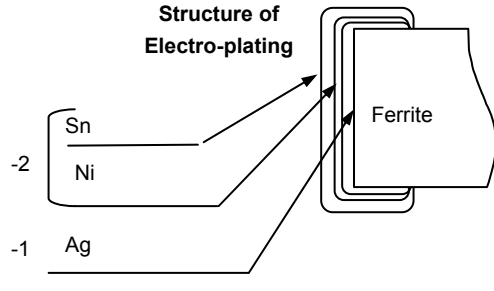

Fig. 4-4

- Ferrite for Bead Series
- Internal electrode (Ag)
- Pull out electrode (Ag)
- 1 Terminal electrode: Inside (Ag)
- 2 Outside (Electro-plating Ni-Sn)

3) Material Information: See Table 4-2.

[Table 4-2]

Code	Part Name	Material Name
	Ferrite Body	Ferrite Powder
	Inner Coils	Silver Paste
	Pull-out Electrode (Ag)	Silver Paste
-1	Terminal Electrode: Inside Ag	Termination Silver Composition
-2	Electro-Plating: Ni/Sn plating	Plating Chemicals

5. Test and Measurement Procedures

5.1 Test Conditions

Unless otherwise specified, the standard atmospheric conditions for measurement/test as:

- a. Ambient Temperature: 20±15
- b. Relative Humidity: 65±20%
- c. Air Pressure: 86kPa to 106kPa

If any doubt on the results, measurements/tests should be made within the following limits:

- a. Ambient Temperature: 20±2
- b. Relative Humidity: 65±5%
- c. Air Pressure: 86kPa to 106kPa

5.2 Visual Examination

- a. Inspection Equipment: 20× magnifier

5.3 Electrical Test

5.3.1 DC Resistance (DCR)

- a. Refer to Appendix A.
- b. Test equipment (Analyzer): High Accuracy Milliohmmeter-HP4338B or equivalent.

5.3.2 Impedance (Z)

- a. Refer to Appendix A.
- b. Test equipment: High Accuracy RF Impedance /Material Analyzer-E4991A or equivalent.
Test fixture: HP16197A for 0603, HP16192A for 1005/1608/2012/3216/4516.
Test signal: -20dBm or 50mV
- c. Test frequency refers to Appendix A.

5.3.3 Rated Current

- a. Refer to Appendix A.
- b. Test equipment (see Fig. 5.3.3-1): Electric Power, Electric current meter, Thermometer.
- c. Measurement method (see Fig. 5.3.3-1):
 1. Set test current to be 0mA.
 2. Measure initial temperature of chip surface.
 3. Gradually increase voltage and measure chip temperature for corresponding current.
- d. Definition of Rated Current (I_r): I_r is direct electric current as chip surface temperature rose just 20 ° against chip initial surface temperature(T_a). (see Fig. 5.3.3-2):

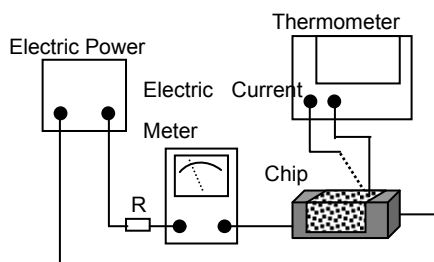

Fig. 5.3.3-1

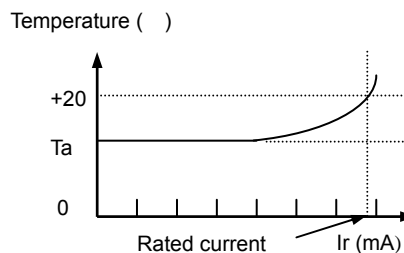

Fig. 5.3.3-2

e. When operating temperatures exceeding +85 °C, derating of current is necessary for chip ferrite beads for which rated

current is 1000mA and over. Please apply the derating curve shown in chart Fig. 5.3.3-3 according to the operating temperature.

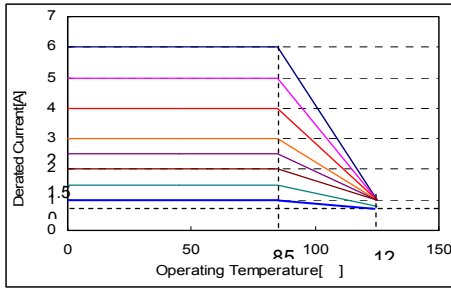
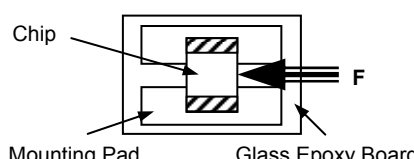
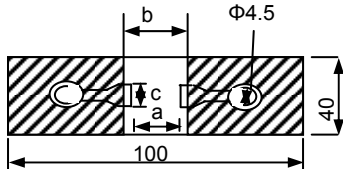
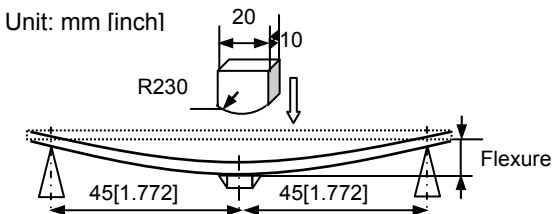
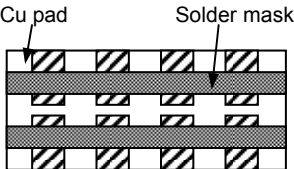

Fig. 5.3.3-3

5.4 Reliability Test

Items	Requirements	Test Methods and Remarks																								
5.4.1 Terminal Strength	No removal or split of the termination or other defects shall occur.  Fig.5.4.1-1	Solder the bead to the testing jig (glass epoxy board shown in Fig. 5.4.1-1) using leadfree solder. Then apply a force in the direction of the arrow. 5N force for 1005 and 1608 series, 10N force for 2012 ,3216 and 4516 series. Keep time: 10±1s. Speed:1.0mm/s.																								
5.4.2 Resistance to Flexure	No visible mechanical damage. <table border="1" data-bbox="298 952 726 1220"> <thead> <tr> <th>Type</th> <th>a</th> <th>b</th> <th>c</th> </tr> </thead> <tbody> <tr> <td>1005[0402]</td> <td>0.4</td> <td>1.5</td> <td>0.5</td> </tr> <tr> <td>1608[0603]</td> <td>1.0</td> <td>3.0</td> <td>1.2</td> </tr> <tr> <td>2012[0805]</td> <td>1.2</td> <td>4.0</td> <td>1.65</td> </tr> <tr> <td>3216[1206]</td> <td>2.2</td> <td>5.0</td> <td>2.0</td> </tr> <tr> <td>4516[1806]</td> <td>2.8</td> <td>8.5</td> <td>2.0</td> </tr> </tbody> </table>  Fig. 5.4.2-1	Type	a	b	c	1005[0402]	0.4	1.5	0.5	1608[0603]	1.0	3.0	1.2	2012[0805]	1.2	4.0	1.65	3216[1206]	2.2	5.0	2.0	4516[1806]	2.8	8.5	2.0	Solder the bead to the test jig (glass epoxy board shown in Fig. 5.4.2-1) Using a leadfree solder. Then apply a force in the direction shown Fig. 5.4.2-2. Flexure: 2mm. Pressurizing Speed: 0.5mm/sec. Keep time: 30 sec.  Unit: mm [inch] Fig. 5.4.2-2
Type	a	b	c																							
1005[0402]	0.4	1.5	0.5																							
1608[0603]	1.0	3.0	1.2																							
2012[0805]	1.2	4.0	1.65																							
3216[1206]	2.2	5.0	2.0																							
4516[1806]	2.8	8.5	2.0																							
5.4.3 Vibration	No visible mechanical damage. Impedance change: within ±20%.  Glass Epoxy Board Fig. 5.4.3-1	Solder the bead to the testing jig (glass epoxy board shown in Fig. 5.4.3-1) using leadfree solder. The bead shall be subjected to a simple harmonic motion having total amplitude of 1.5mm, the frequency being varied uniformly between the approximate limits of 10 and 55 Hz. The frequency range from 10 to 55 Hz and return to 10 Hz shall be traversed in approximately 1 minute. This motion shall be applied for a period of 2 hours in each 3 mutually perpendicular directions (total of 6 hours).																								
5.4.4 Dropping	No visible mechanical damage. Impedance change: within ±20%.	Drop chip bead 10 times on a concrete floor from a height of 100 cm.																								
5.4.5 Temperature	Impedance change should be within ±20% of initial value measuring at 20 .	Temperature range: -55 ~ +125 . Reference temperature: +20 .																								
5.4.6 Solderability	No visible mechanical damage. Wetting shall exceed 75% coverage for 0603 series; exceed 95% for others	Solder temperature: 240±2 . Duration: 3 sec. Solder: Sn/3.0Ag/0.5Cu. Flux: 25% Resin and 75% ethanol in weight.																								

5.4.7 Resistance to Soldering Heat	No visible mechanical damage. Wetting shall exceed 75% coverage for 0603 series; exceed 95% for others Impedance change: within $\pm 20\%$.	Solder temperature: 260 ± 3 Duration: 5 sec. Solder: Sn/3.0Ag/0.5Cu. Flux: 25% Resin and 75% ethanol in weight. The chip shall be stabilized at normal condition for 1~2 hours before measuring.
5.4.8 Thermal Shock	No mechanical damage. Impedance change: Within $\pm 20\%$	Temperature, Time: (See Fig. 5.4.8-1) -55 for 30 \pm 3 min \rightarrow 125 for 30 \pm 3min Transforming interval: Max. 20 sec. Tested cycle: 100 cycles. The chip shall be stabilized at normal condition for 1~2 hours before measuring.
<p>Fig.5.4.8-1</p>		
5.4.9 Resistance to Low Temperature	No mechanical damage. Impedance change: within $\pm 20\%$	Temperature: -55 ± 2 Duration: 1000^{+24} hours. The chip shall be stabilized at normal condition for 1~2 hours before measuring.
5.4.10 Resistance to High Temperature	No mechanical damage. Impedance change: within $\pm 20\%$	Temperature: 125 ± 2 Duration: 1000^{+24} hours. The chip shall be stabilized at normal condition for 1~2 hours before measuring.
5.4.11 Damp Heat (Steady States)	No visible mechanical damage. Impedance change: within $\pm 20\%$	Temperature: 60 ± 2 Humidity: 90% to 95% RH. Duration: 1000^{+24} hours. The chip shall be stabilized at normal condition for 1~2 hours before measuring.
5.4.12 Loading Under Damp Heat	No visible mechanical damage. Impedance change: within $\pm 20\%$	Temperature: 60 ± 2 Humidity: 90% to 95% RH. Duration: 1000^{+24} hours. Applied current: Rated current. The chip shall be stabilized at normal condition for 1~2 hours before measuring.
5.4.13 Loading at High Temperature (Life Test)	No visible mechanical damage. Impedance change: within $\pm 20\%$	Temperature: 85 ± 2 Duration: 1000^{+24} hours. Applied current: Rated current. The chip shall be stabilized at normal condition for 1~2 hours before measuring.

6. Packaging, Storage

6.1 Packaging

Tape Carrier Packaging:

Packaging code: T

- a. Tape carrier packaging are specified in attached figure **Fig. 6.1-1~4**
- b. Tape carrier packaging quantity please see the following table:

Type	1005[0402]	1608[0603]	2012[0805]	3216[1206]		4516[1806]
T(mm)	0.5 \pm 0.15	0.8 \pm 0.15	0.85 \pm 0.2	0.85 \pm 0.2	1.1 \pm 0.2	1.60 \pm 0.2
Tape	Paper Tape	Paper Tape	Paper Tape	Paper Tape	Embossed Tape	Embossed Tape
Quantity	10K	4K	4K	3K	3K	2K

(1) Taping Drawings (Unit: mm)

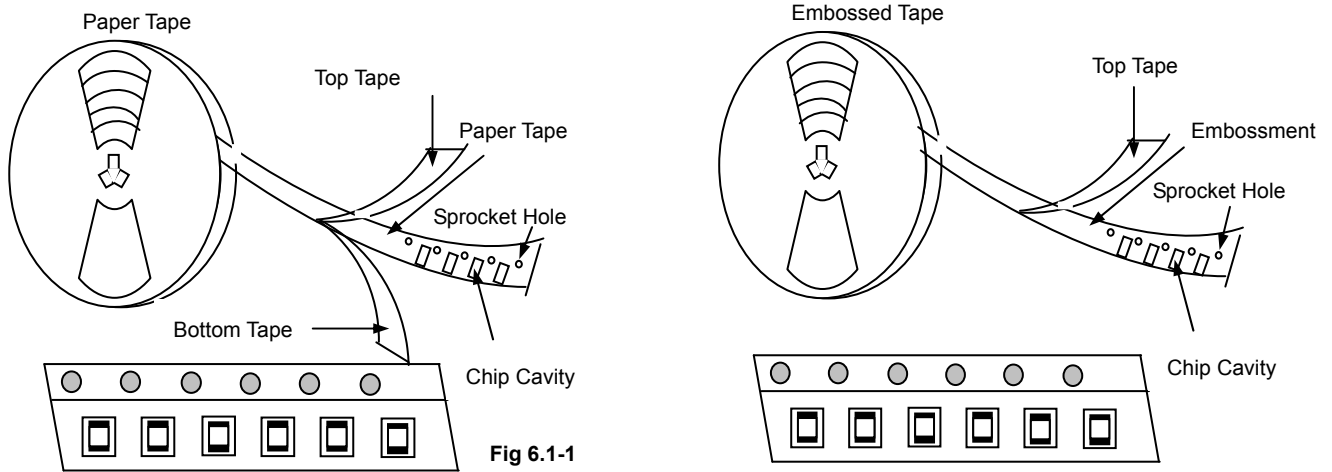

Fig 6.1-1

Remark: The sprocket holes are to the right as the tape is pulled toward the user.

(2) Taping Dimensions (Unit: mm)

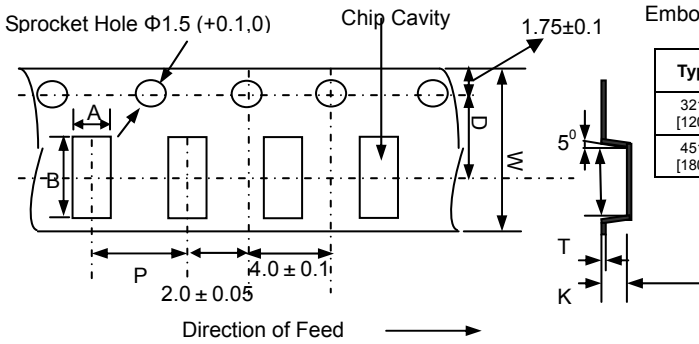

Fig 6.1-2

Embossed Tape and Reel

Type	A	B	P	D	W	K max	Tmax	H
3216 [1206]	1.88±0.2	3.5±0.2	4.0±0.1	3.5±0.05	8	1.27	0.3	10
4516 [1806]	1.9±0.2	4.9±0.2	4.±0.1	5.5±0.05	12	1.88	0.32	13

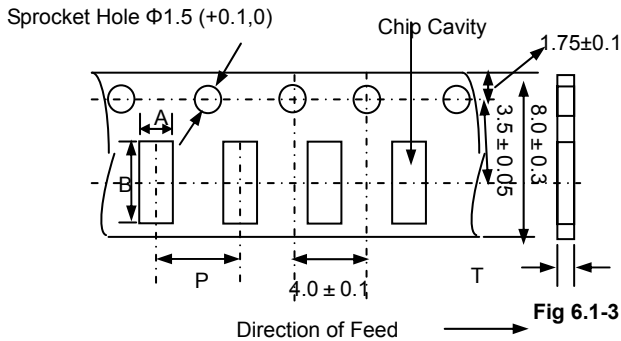

Fig 6.1-3

Paper Tape and Reel

Type	A	B	P	T max	H
1005[0402]	0.65 ± 0.2	1.15 ± 0.2	2.0 ± 0.1	0.80	10
1608[0603]	1.0±0.2	1.8±0.2	4.0±0.1	1.1	10
2012[0805]	1.5±0.2	2.3±0.2	4.0±0.1	1.1	10
3216[1206]	1.9±0.2	3.5±0.2	4.0±0.1	1.1	10

(3) Reel Dimensions (Unit: mm)

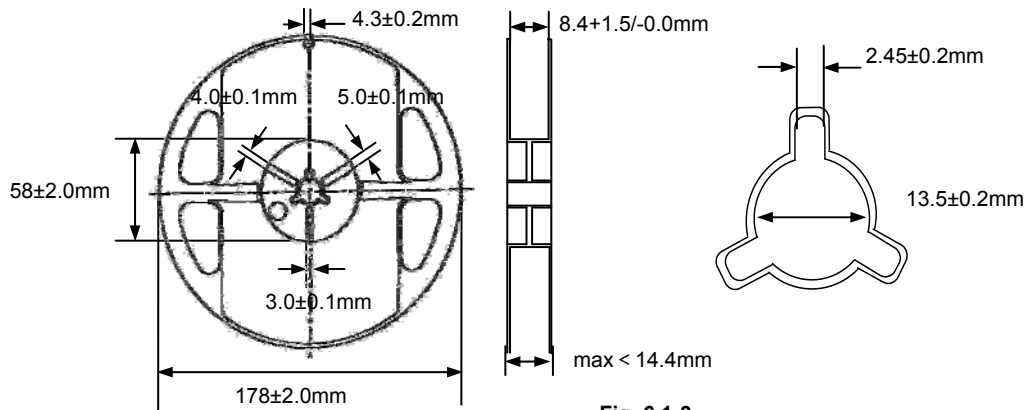

Fig. 6.1-3

6.2 Storage

- The solderability of the external electrode may be deteriorated if packages are stored where they are exposed to high humidity. Package must be stored at 40% or less and 70% RH or less.
- The solderability of the external electrode may be deteriorated if packages are stored where they are exposed to dust of harmful gas (e.g. HCl, sulfurous gas of H₂S).
- Packaging material may be deformed if package are stored where they are exposed to heat of direct sunlight.
- Solderability of the products with external dimensions as 0603[0201] specified in **Clause 5.4.6** shall be guaranteed for 6months from the date of delivery on condition that they are stored at the environment specified in **Clause 3**. For those parts, which passed more than 6 months shall be checked solder-ability before use.
- Solderability of the products, except ones with external dimensions as 0603[0201], specified in **Clause 5.4.6** shall be guaranteed for 12 months from the date of delivery on condition that they are stored at the environment specified in **Clause 3**. For those parts, which passed more than 12 months shall be checked solder-ability before use.

7. Recommended Soldering Technologies

7.1 Reflowing Profile:

Preheat condition: 150 ~200 /60~120sec.

Allowed time above 217 : 60~90sec.

Max temp: 260

Max time at max temp: 10sec.

Solder paste: Sn/3.0Ag/0.5Cu

Allowed Reflow time: 2x max

[Note: The reflow profile in the above table is only for qualification and is not meant to specify board assembly profiles. Actual board assembly profiles must be based on the customer's specific board design, solder paste and process, and should not exceed the parameters as the Reflow profile shows.]

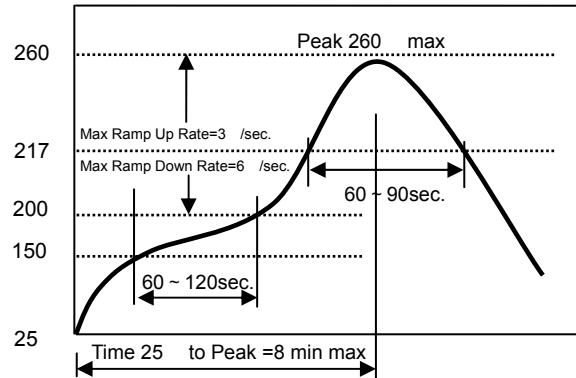

7.2 Iron Soldering Profile.

Iron soldering power: Max.30W

Pre-heating: 150 / 60sec.

Soldering Tip temperature: 350 Max.

Soldering time: 3sec Max.

Solder paste: Sn/3.0Ag/0.5Cu

Max.1 times for iron soldering

[Note: Take care not to apply the tip of the soldering iron to the terminal electrodes.]

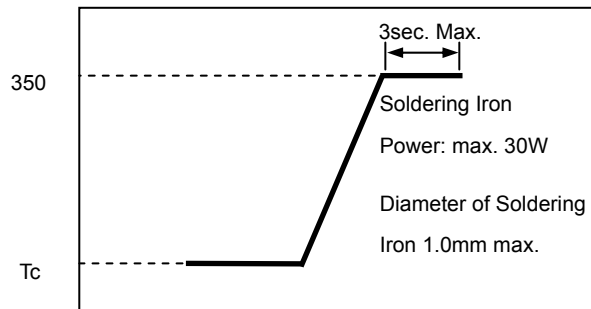

8. Supplier Information

- Supplier:

Shenzhen Sunlord Electronics Co., Ltd.

- Manufacturer:

Shenzhen Sunlord Electronics Co., Ltd.

- Manufacturing Address:

Sunlord Industrial Park, Dafuyuan Industrial Zone, Guanlan, Shenzhen, China 518110

Appendix A: Electrical Characteristics

. PZ1005 Series of Beads

Part Number	Impedance (Ω)	Z Test Freq. (MHz)	DCR (Ω) Max.	I _r (mA) Max.	Thickness (mm) [inch]
PZ1005D100-1R0TF	0~30	100	0.05	1000	0.5±0.15 [.020±.006]
PZ1005E100-1R8TF	0~15	100	0.02	1800	
PZ1005E700-R80TF	70±25%	100	0.10	800	
PZ1005E121-R70TF	120±25%	100	0.13	700	
PZ1005E221-R60TF	220±25%	100	0.18	600	
PZ1005E601-R45TF	600±25%	100	0.34	450	
PZ1005U700-1R2TF	70±25%	100	0.10	1200	
PZ1005U121-1R0TF	120±25%	100	0.12	1000	
PZ1005U221-R80TF	220±25%	100	0.18	800	
PZ1005U601-R45TF	600±25%	100	0.34	450	

. PZ1608 Series of Beads

Part Number	Impedance (Ω)	Z Test Freq. (MHz)	DCR (Ω) Max.	I _r (mA) Max.	Thickness (mm) [inch]
PZ1608D300-3R0TF	30±25%	100	0.03	3000	0.8±0.15 [.031±.006]
PZ1608D600-2R0TF	60±25%	100	0.08	2000	
PZ1608D750-1R0TF	75±25%	100	0.15	1000	
PZ1608D121-1R0TF	120±25%	100	0.20	1000	
PZ1608D221-1R0TF	220±25%	100	0.20	1000	
PZ1608D601-R50TF	600±25%	100	0.35	500	
PZ1608E600-1R4TF	60±25%	100	0.10	1400	
PZ1608U100-3R0TF	0~15	100	0.02	3000	
PZ1608U300-3R0TF	30±25%	100	0.03	3000	
PZ1608U600-2R5TF	60±25%	100	0.04	2500	
PZ1608U121-2R0TF	120±25%	100	0.05	2000	
PZ1608U221-1R4TF	220±25%	100	0.10	1400	
PZ1608U331-1R2TF	330±25%	100	0.14	1200	
PZ1608U391-1R0TF	390±25%	100	0.14	1000	
PZ1608U471-1R0TF	470±25%	100	0.20	1000	

. PZ2012 Series of Beads

Part Number	Impedance (Ω)	Z Test Freq. (MHz)	DCR (Ω) Max.	I _r (mA) Max.	Thickness (mm) [inch]
PZ2012D390-4R0TF	39±25%	100	0.02	4000	0.85±0.2 [.033±.008]
PZ2012D800-3R0TF	80±25%	100	0.04	3000	
PZ2012D121-2R5TF	120±25%	100	0.06	2500	
PZ2012D221-1R5TF	220±25%	100	0.08	1500	
PZ2012D301-1R5TF	300±25%	100	0.12	1500	
PZ2012D471-R80TF	470±25%	100	0.25	800	
PZ2012D601-R80TF	600±25%	100	0.25	800	
PZ2012U300-3R0TF	30±25%	100	0.02	3000	
PZ2012U300-4R0TF	30±25%	100	0.015	4000	
PZ2012U600-3R0TF	60±25%	100	0.025	3000	
PZ2012U121-2R5TF	120±25%	100	0.04	2500	
PZ2012U221-2R0TF	220±25%	100	0.07	2000	
PZ2012U301-1R5TF	300±25%	100	0.10	1500	
PZ2012U421-1R0TF	420±25%	100	0.20	1000	
PZ2012U601-R80TF	600±25%	100	0.25	800	

. PZ3216 Series of Beads

Part Number	Impedance (Ω)	Z Test Freq. (MHz)	DCR (Ω) Max.	I _r (mA) Max.	Thickness (mm) [inch]
PZ3216D190-6R0TF	19±25%	100	0.010	6000	0.85±0.2 [.033±.008]
PZ3216D380-5R0TF	38±25%	100	0.015	5000	
PZ3216D600-4R0TF	60±25%	100	0.02	4000	
PZ3216D121-2R5TF	120±25%	100	0.04	2500	
PZ3216D501-2R0TF	500±25%	100	0.07	2000	

PZ3216D601-1R5TF	600±25%	100	0.10	1500
PZ3216U300-6R0TF	30±25%	100	0.01	6000
PZ3216U600-4R0TF	60±25%	100	0.025	4000
PZ3216U121-3R0TF	120±25%	100	0.03	3000
PZ3216U221-2R0TF	220±25%	100	0.08	2000
PZ3216U301-2R0TF	300±25%	100	0.10	2000
PZ3216U391-2R0TF	390±25%	100	0.07	2000
PZ3216U601-1R5TF	600±25%	100	0.10	1500
PZ3216U102-R50TF	1000±25%	100	0.30	500

Note: The thickness of PZ3216 series may be increased to 1.1±0.2 mm when the Ir of product increased.

. PZ4516 Series of Beads

Part Number	Impedance (Ω)	Z Test Freq. (MHz)	DCR (Ω) Max.	Ir (mA) Max.	Thickness (mm)[inch]
PZ4516U600-6R0TF	60±25%	100	0.01	6000	1.6±0.2 [.063±.008]
PZ4516U720-6R0TF	72±25%	100	0.01	6000	
PZ4516U181-3R0TF	180±25%	100	0.025	3000	
PZ4516U471-2R0TF	470±25%	100	0.05	2000	

D, E, U Material Comparison

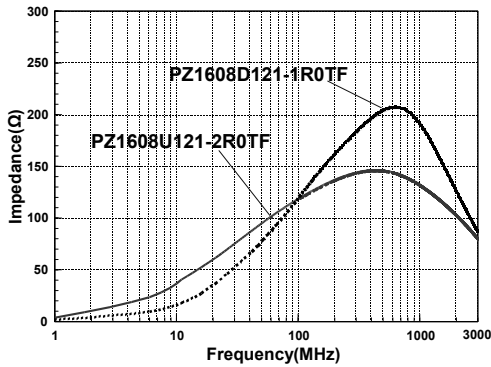

Impedance Frequency Characteristics

PZ1005 series

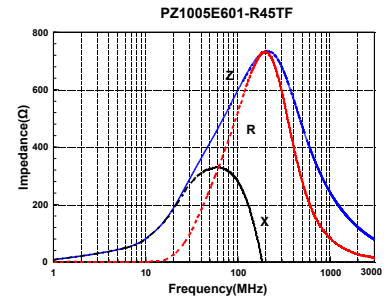
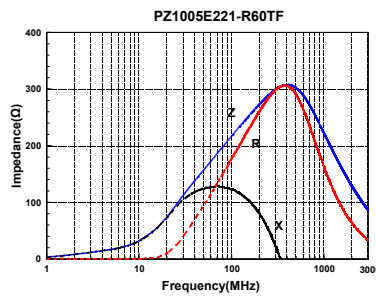
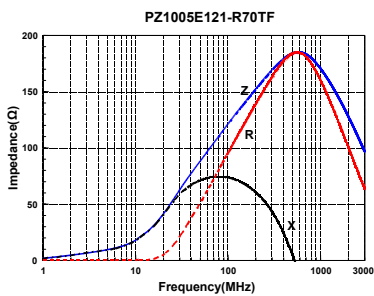
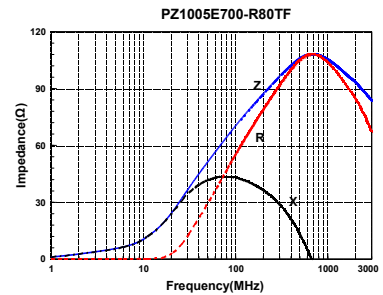
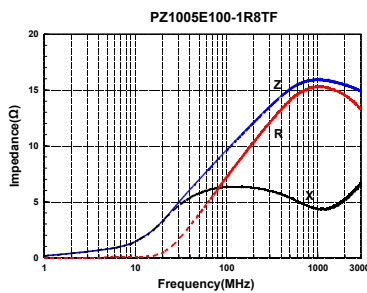
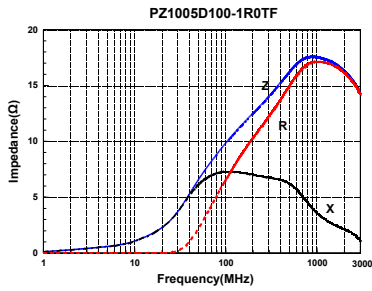

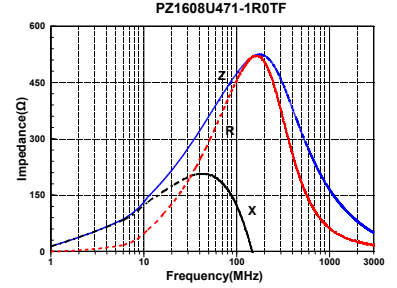
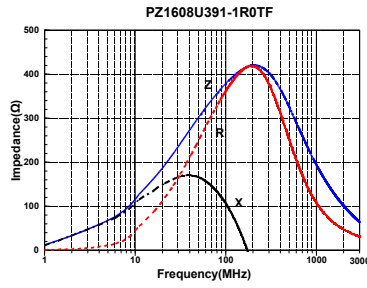
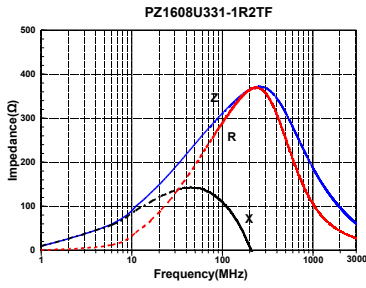

PZ2012 series

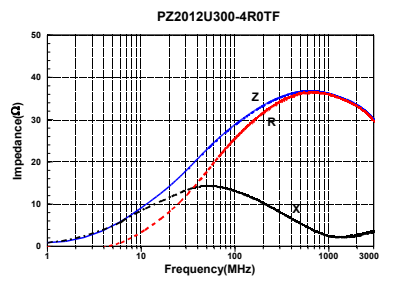
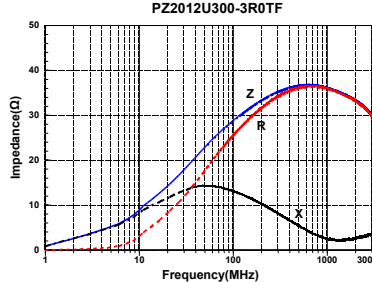
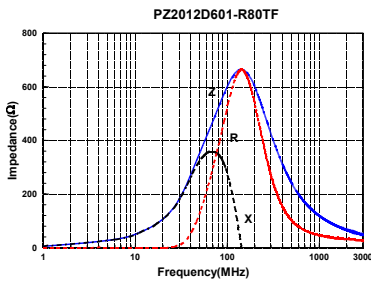
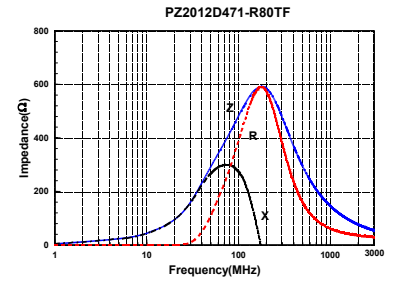
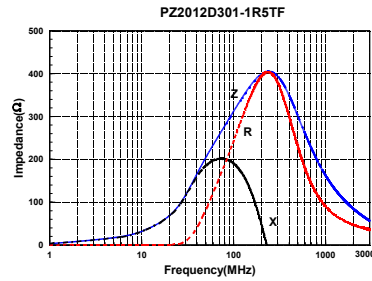
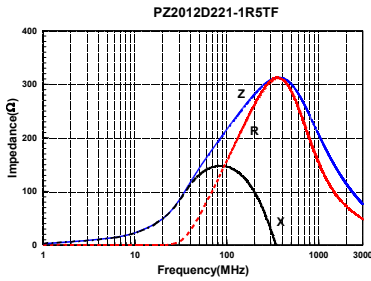
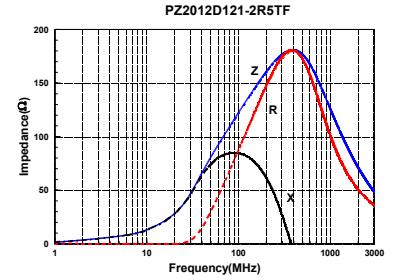
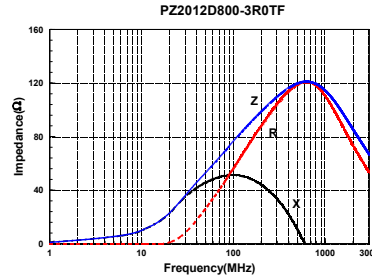
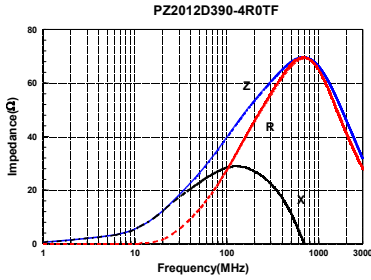

PZ2012series

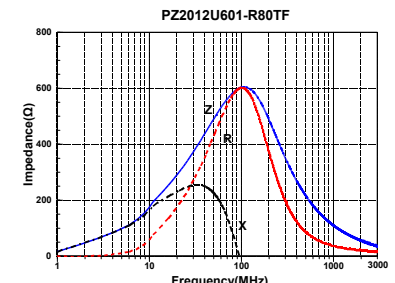
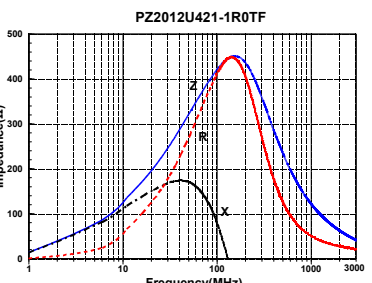
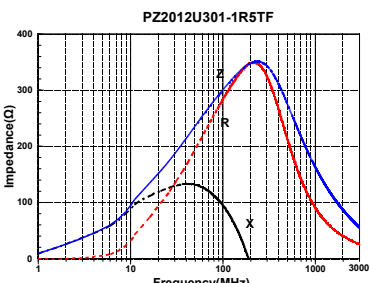
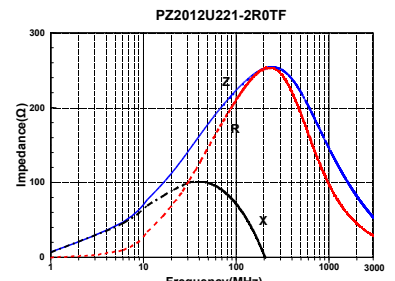
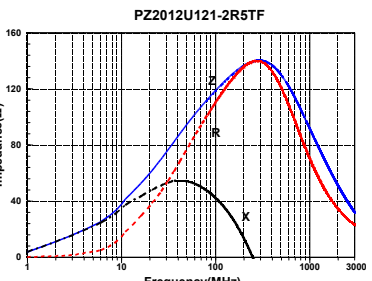
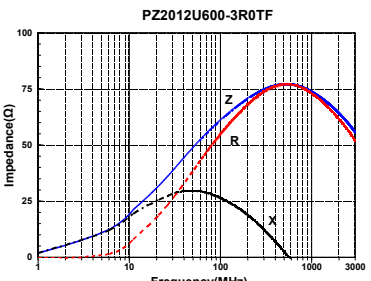

PZ3216 series

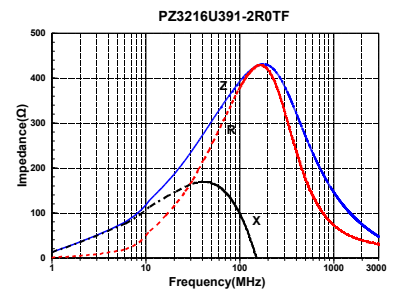
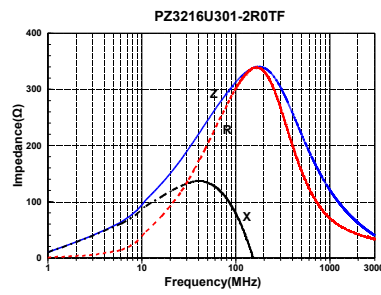
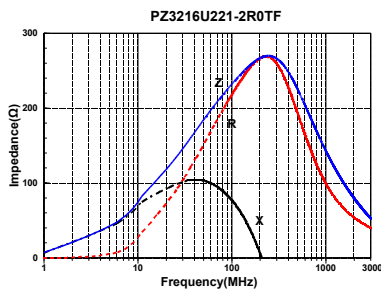
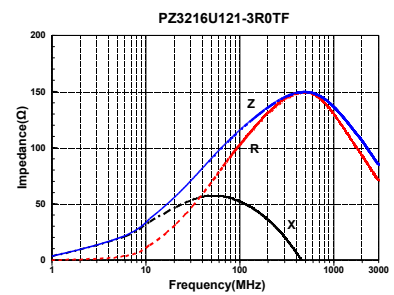
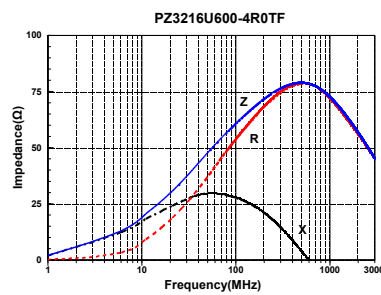
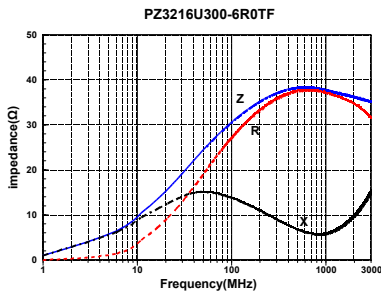
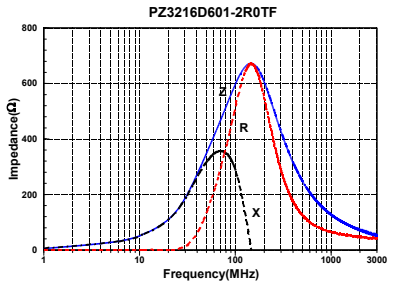
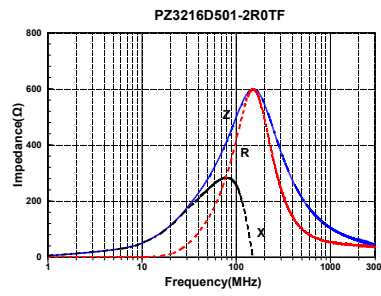
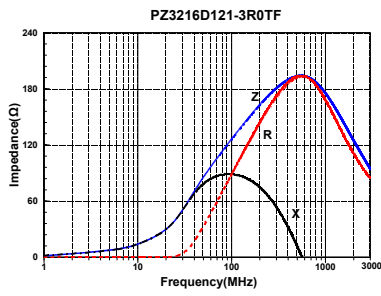
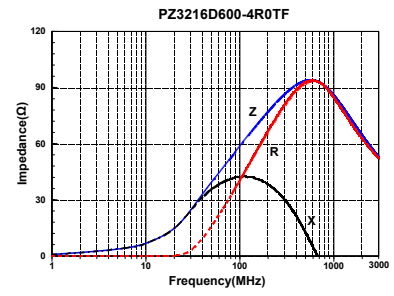
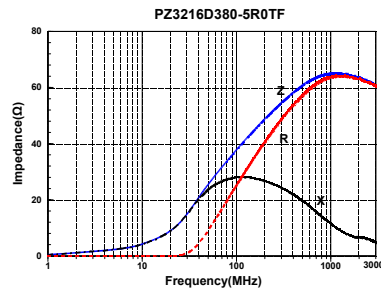
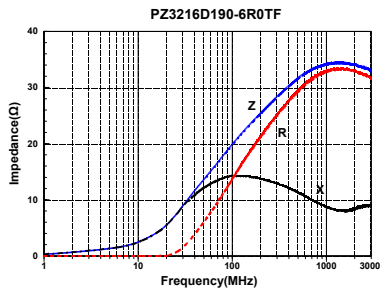

PZ3216series

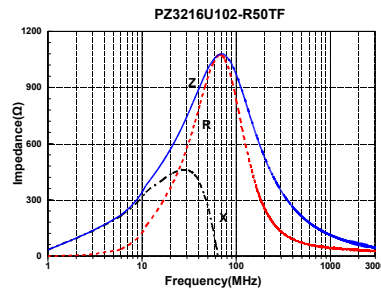
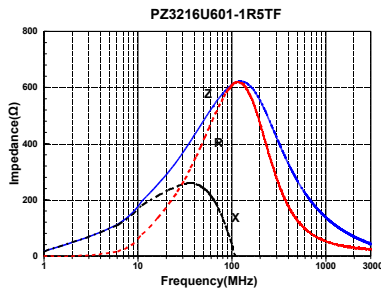

PZ4516 series

