

## TO-92 Plastic-Encapsulate Transistors

### S9018 TRANSISTOR (NPN)

#### FEATURES

- High Current Gain Bandwidth Product

#### MAXIMUM RATINGS (T<sub>a</sub>=25°C unless otherwise noted)

Symbol	Parameter	Value	Unit
V <sub>CBO</sub>	Collector-Base Voltage	25	V
V <sub>CEO</sub>	Collector-Emitter Voltage	18	V
V <sub>EBO</sub>	Emitter-Base Voltage	4	V
I <sub>C</sub>	Collector Current -Continuous	50	mA
P <sub>C</sub>	Collector Power Dissipation	0.4	W
R <sub>θJA</sub>	Thermal Resistance From Junction To Ambient	312.5	°C/W
T <sub>j</sub>	Junction Temperature	150	°C
T <sub>stg</sub>	Storage Temperature	-55~+150	°C

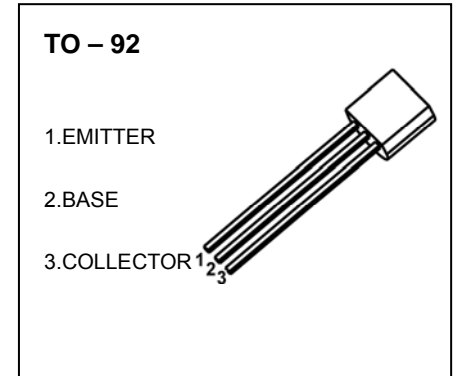

#### ELECTRICAL CHARACTERISTICS (T<sub>a</sub>=25°C unless otherwise specified)

Parameter	Symbol	Test conditions	Min	Typ	Max	Unit
Collector-base breakdown voltage	V <sub>(BR)CBO</sub>	I <sub>C</sub> =100μA, I <sub>E</sub> =0	25			V
Collector-emitter breakdown voltage	V <sub>(BR)CEO</sub>	I <sub>C</sub> =0.1mA, I <sub>B</sub> =0	18			V
Emitter-base breakdown voltage	V <sub>(BR)EBO</sub>	I <sub>E</sub> =100μA, I <sub>C</sub> =0	4			V
Collector cut-off current	I <sub>CBO</sub>	V <sub>CB</sub> =20V, I <sub>E</sub> =0			0.1	nA
Collector cut-off current	I <sub>CEO</sub>	V <sub>CE</sub> =15V, I <sub>B</sub> =0			0.1	μA
Emitter cut-off current	I <sub>EBO</sub>	V <sub>EB</sub> =3V, I <sub>C</sub> =0			0.1	μA
DC current gain	h <sub>FE</sub>	V <sub>CE</sub> =5V, I <sub>C</sub> =1mA	28		270	
Collector-emitter saturation voltage	V <sub>CE(sat)</sub>	I <sub>C</sub> =10mA, I <sub>B</sub> =1mA			0.5	V
Base-emitter saturation voltage	V <sub>BE(sat)</sub>	I <sub>C</sub> =10mA, I <sub>B</sub> =1mA			1.42	V
Transition frequency	f <sub>T</sub>	V <sub>CE</sub> =5V, I <sub>C</sub> =50mA, f=400MHz		800		MHz

#### CLASSIFICATION OF h<sub>FE</sub>

RANK	D	E	F	G	H	I	J
RANGE	28-45	39-60	54-80	72-108	97-146	132-198	180-270

# Typical Characteristics

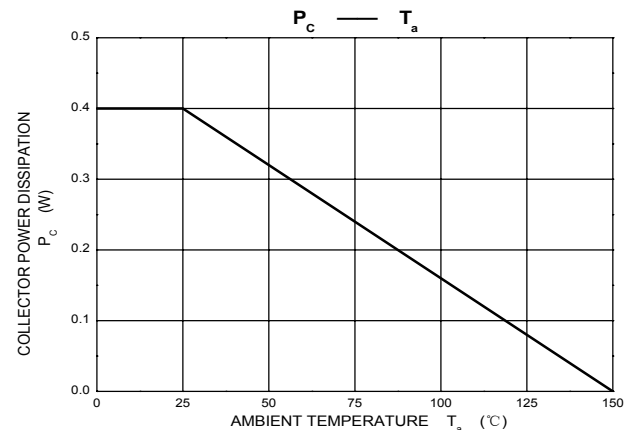
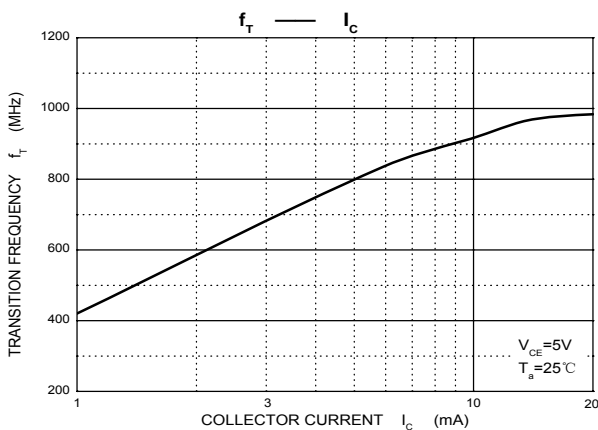
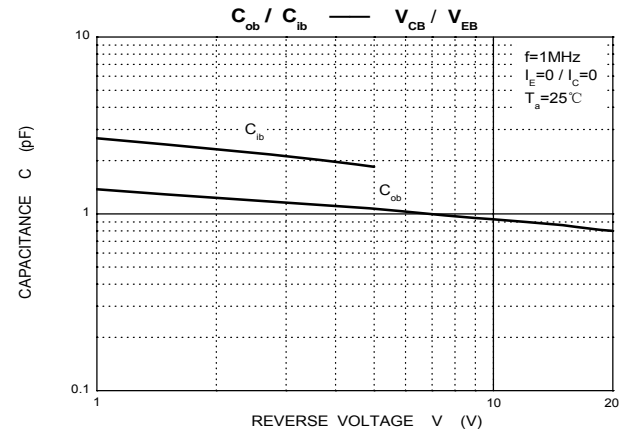
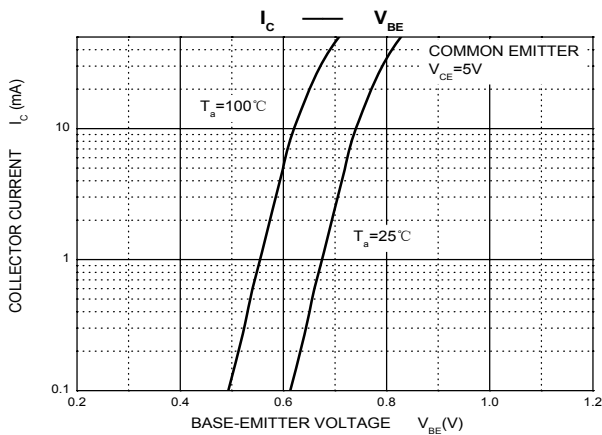
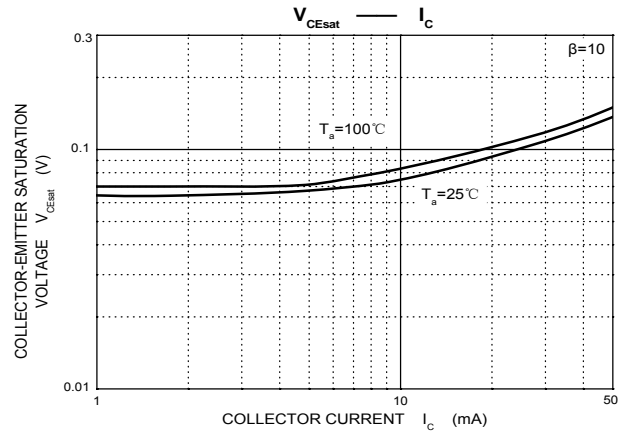
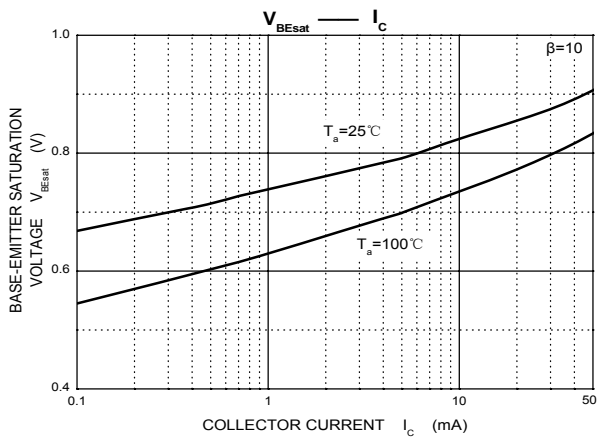
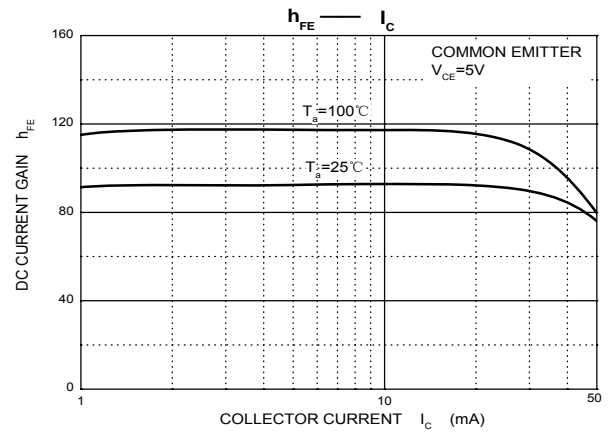
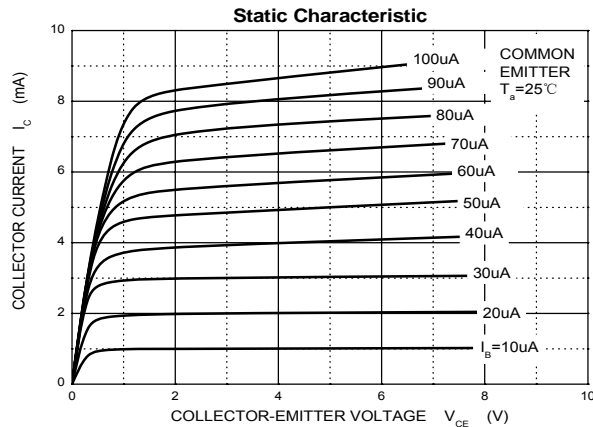

## TO-92 Package Outline Dimensions



Symbol	Dimensions In Millimeters		Dimensions In Inches	
	Min	Max	Min	Max
A	3.300	3.700	0.130	0.146
A1	1.100	1.400	0.043	0.055
b	0.380	0.550	0.015	0.022
c	0.360	0.510	0.014	0.020
D	4.300	4.700	0.169	0.185
D1	3.430		0.135	
E	4.300	4.700	0.169	0.185
e	1.270 TYP		0.050 TYP	
e1	2.440	2.640	0.096	0.104
L	14.100	14.500	0.555	0.571
Φ		1.600		0.063
h	0.000	0.380	0.000	0.015

## TO-92 Suggested Pad Layout



### Note:

1. Controlling dimension: in millimeters.
2. General tolerance:  $\pm 0.05\text{mm}$ .
3. The pad layout is for reference purposes only.

### NOTICE

JCET reserve the right to make modifications, enhancements, improvements, corrections or other changes without further notice to any product herein. JCET does not assume any liability arising out of the application or use of any product described herein.

TO-92 PACKAGE TAPEING DIMENSION



Dimiensions are in millimeter								
A1	A	T	P	P0	P2	F1	F2	W
4.5	4.5	3.5	12.7	12.7	6.35	2.5	2.5	18.0
W0	W1	W2	H	H0	D0	t1	t2	ΔP
6.0	9.0	1.0 MAX.	19.0	16.0	4.0	0.4	0.2	0

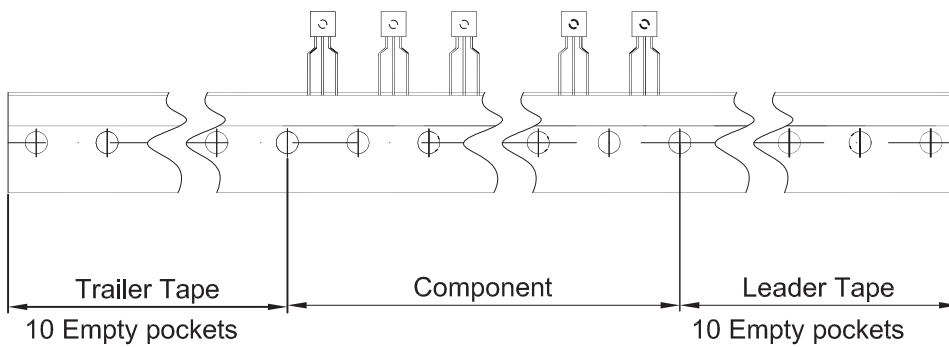

Package	Box	Box Size(mm)	Carton	Carton Size(mm)
TO-92	2000 pcs	333×162×43	20,000 pcs	350×340×250