

ROHM's Selection Operational Amplifier/Comparator Series



# Operational Amplifiers: Low Noise

**BA4558F,BA4558RF/FV/FVM,BA4560F,BA4560RF/FV/FVM,BA4580RF/FVM  
BA2115F/FVM,BA15218F,BA14741F,BA15532FBA4510F/FV**

No.09049EAT02

●Description

General-purpose BA4558 / BA4560 / BA15218 / BA14741 / BA15532 / BA4510 family and high-reliability BA4558R / BA4560R / BA4580R / BA2115 family integrate two or four independent Op-Amps on a single chip.

Especially, this series is suitable for any audio applications due to low noise and low distortion characteristics and are usable for other many applications by wide operating supply voltage range.

BA4558R/BA4560R/BA4580R/BA2115 are high-reliability products with extended operating temperature range and high ESD tolerance.

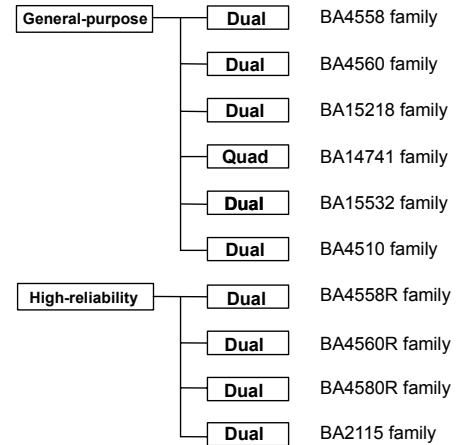

●Features

- 1) High voltage gain, low noise, low distortion
- 2) Internal phase compensation
- 3) No latch up immunity
- 4) Wide operating supply voltage
 

±4.0[V]~±15.0[V](split supply)	(BA4558/BA4560/BA4558R/BA4560R family)
±2.0[V]~±16.0[V](split supply)	(BA4580R/BA15218 family)
±2.0[V]~±18.0[V](split supply)	(BA14741 family)
±3.0[V]~±20.0[V](split supply)	(BA15532 family)
±1.0[V]~±3.5[V](split supply)	(BA4510 family)
±1.0[V]~±7.0[V](split supply)	(BA2115 family)
- 5) Internal ESD protection  
Human body mode (HBM) ±5000[V](Typ.) (BA4558R/BA4560R/BA4580R/BA2115 family)
- 6) Wide temperature range
 

-40[°C]~+85[°C]	(BA4558/BA4560/BA15218/BA14741/BA2115 family)
-40[°C]~+105[°C]	(BA4558R/BA4560R/BA4580R family)

●Pin Assignments

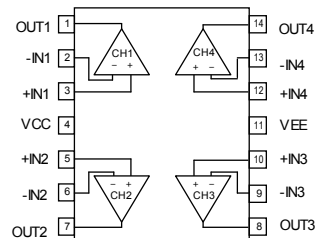
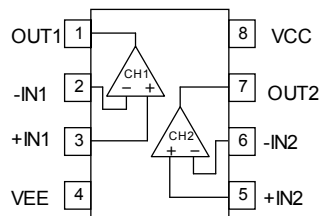

SOP8		SSOP-B8		MSOP8	
BA4558F	BA4558R F	BA4558R FV	BA4558R FVM	BA4558R FV	BA4558R FVM
BA4560F	BA4560R F	BA4560R FV	BA4560R FVM	BA4560R FV	BA4560R FVM
BA15218F	BA4580R F	BA4510FV	BA4580R FVM	BA4580R FV	BA4580R FVM
BA15532F	BA2115F		BA2115FVM		
BA4510F					

SOP14
BA14741F

●Absolute maximum rating (Ta=25[°C])

OBA4558/BA4560 family,BA4558R/BA4560R/BA4580R family

Parameter	Symbol	Rating					Unit
		BA4558 family	BA4560 family	BA4558R family	BA4560R family	BA4580R family	
Supply Voltage	VCC-VEE	+36					V
Differential Input Voltage <sup>(*)</sup>	Vid	(VCC-VEE)		36			V
Input Common-mode voltage range	Vicm	VEE~VCC		(VEE-0.3)~VEE+36			V
Operating Supply Voltage	Vopr	8~30 (±4~±15)		8~30 (±4~±15)		4~32(±2~±16)	V
Output Current	Io	-		-		±50	mA
Operating Temperature	Topr	-40~+85		-40~+105			°C
Storage Temperature	Tstg	-55~+125		-55~+150			°C
Maximum Junction Temperature	Tjmax	+125		+150			°C

Note: Absolute maximum rating item indicates the condition which must not be exceeded.

Application of voltage in excess of absolute maximum rating or use out absolute maximum rated temperature environment may cause deterioration of characteristics.

(\*) The voltage difference between inverting input and non-inverting input is the differential input voltage. Then input terminal voltage is set to more than VEE.

●Electrical characteristics

OBA4558/BA4560 family (Unless otherwise specified VCC=+15[V], VEE=-15[V], Ta=25[°C])

Parameter	Symbol	Temperature Range	Guaranteed limit						Unit	Condition
			BA4558 family			BA4560 family				
			Min.	Typ.	Max.	Min.	Typ.	Max.		
Input Offset Voltage <sup>(*)</sup>	Vio	25°C	-	0.5	6	-	0.5	6	mV	Rs ≤ 10[kΩ]
Input Offset Current <sup>(*)</sup>	Iio	25°C	-	5	200	-	5	200	nA	-
Input Bias Current <sup>(*)</sup>	Ib	25°C	-	60	500	-	50	500	nA	-
Supply Current	ICC	25°C	-	3	6	-	4	7.5	mA	RL = ∞ All Op-Amps
Maximum Output Voltage	VOM	25°C	±12	±14	-	±12	±14	-	V	RL ≥ 10[kΩ]
			±10	±13	-	±10	±13	-		RL ≥ 2[kΩ]
Large Single Voltage Gain	AV	25°C	86	100	-	86	100	-	dB	RL ≥ 2[kΩ], VOUT = ±10[V]
Input Common-mode Voltage Range	Vicm	25°C	±12	±14	-	±12	±14	-	V	-
Common-mode Rejection Ratio	CMRR	25°C	70	90	-	70	90	-	dB	Rs ≤ 10[kΩ]
Power Supply Rejection Ratio	PSRR	25°C	76.3	90	-	76.3	90	150	dB	Rs ≤ 10[kΩ]
Channel Separation	CS	25°C	-	105	-	-	-	-	dB	f = 1[kHz] Input referred
Slew Rate	SR	25°C	-	1.0	-	-	4	-	V/μs	AV = 0[dB], RL ≥ 2[kΩ]
Gain Bandwidth Product	GBW	25°C	-	-	-	-	10	-	MHz	f = 10[kHz]
Input Referred Noise Voltage	Vn	25°C	-	-	-	-	-	2.2	μV	Rs = 2.2[kΩ], BW = 10[Hz] ~ 30[kHz], RIAA

(\*) Absolute value

(\*) Current direction: Since first input stage is composed with PNP transistor, input bias current flows out of IC.

●Electrical characteristics

OBA4558R/BA4560R family (Unless otherwise specified VCC=+15[V], VEE=-15[V], Full range -40[°C]~+105[°C])

Parameter	Symbol	Temperature Range	Guaranteed limit						Unit	Condition
			BA4558R family			BA4560R family				
			Min.	Typ.	Max.	Min.	Typ.	Max.		
Input Offset Voltage (*4)	Vio	25°C	-	0.5	6	-	0.5	6	mV	VOU=0[V]
		Full range	-	-	7	-	-	7		
Input Offset Current (*4)	Iio	25°C	-	5	200	-	5	200	nA	VOU=0[V]
		Full range	-	-	200	-	-	200		
Input Bias Current (*5)	Ib	25°C	-	60	500	-	50	500	nA	VOU=0[V]
		Full range	-	-	800	-	-	800		
Supply Current	ICC	25°C	-	3	6	-	3	7	mA	RL=∞ All Op-Amps VIN+=0[V]
		Full range	-	-	6.5	-	-	7.5		
Maximum Output Voltage	VOM	25°C	±10	±13	-	±12	±14	-	V	RL ≥ 2[kΩ]
		Full range	±10	-	-	-	-	-		Io=25[mA]
		25°C	-	-	-	±10	±11.5	-		RL ≥ 10[kΩ]
		Full range	±12	±14	-	-	-	-		
Large Single Voltage Gain	AV	25°C	86	100	-	86	100	-	dB	RL ≥ 2[kΩ], VO=±10[V], Vicm=0[V]
		Full range	83	-	-	83	-	-		
Input Common-mode Voltage Range	Vicm	25°C	±12	±14	-	±12	±14	-	V	VOU=±12[V]
		Full range	±12	-	-	±12	-	-		
Common-mode Rejection Ratio	CMRR	25°C	70	90	-	70	90	-	dB	VOU=±12[V]
Power Supply Rejection Ratio	PSRR	25°C	76.5	90	-	76.5	90	-	dB	Ri ≤ 10[kΩ]
Channel Separation	CS	25°C	-	105	-	-	105	-	dB	f=1[kHz]
Slew Rate	SR	25°C	-	1	-	-	4	-	V/μs	AV=0[dB], RL=10[kΩ] CL=100[pF]
Unity Gain Frequency	ft	25°C	-	2	-	-	4	-	MHz	RL=2[kΩ]
Total Harmonic Distortion	THD	25°C	-	0.005	-	-	0.003	-	%	AV=20[dB], RL=10[kΩ] VOU=5[Vrms], f=1[kHz]
Input Referred Noise Voltage	Vn	25°C	-	12	-	-	8	-	nV/√Hz	RS=100[Ω], Vi=0[V] f=1[kHz]

(\*4) Absolute value

(\*5) Current direction: Since first input stage is composed with PNP transistor, input bias current flows out of IC.

●Electrical characteristics

OBA4580R family (Unless otherwise specified VCC=+15[V], VEE=-15[V], Ta=25[°C])

Parameter	Symbol	Temperature Range	Guaranteed limit			Unit	Condition
			BA4580R family				
			Min.	Typ.	Max.		
Input Offset Voltage (*6)	Vio	25°C	-	0.3	3	mV	Rs ≤ 10[kΩ]
Input Offset Current (*6)	Iio	25°C	-	5	200	nA	-
Input Bias Current (*7)	Ib	25°C	-	100	500	nA	-
Large Single Voltage Gain	AV	25°C	90	110	-	dB	RL ≥ 10[kΩ], VOU=±10[V]
Maximum Output Voltage	VOM	25°C	±12	±13.5	-	V	RL ≥ 2[kΩ]
Input Common-mode Voltage Range	Vicm	25°C	±12	±13.5	-	V	-
Common-mode Rejection Ratio	CMRR	25°C	80	110	-	dB	Rs ≤ 10[kΩ]
Power Supply Rejection Ratio	PSRR	25°C	80	110	-	dB	Rs ≤ 10[kΩ]
Supply Current	ICC	25°C	-	6	9	mA	RL=∞ All Op-Amps, VIN+=0[V]
Slew Rate	SR	25°C	-	5	-	V/μs	RL ≥ 2[kΩ]
Unity Gain Frequency	ft	25°C	-	5	-	MHz	RL=2[kΩ]
Total Harmonic Distortion	THD	25°C	-	0.0005	-	%	Av=20[dB], VOU=5[Vrms], RL=2[kΩ] f=1[kHz], 20[Hz]~20[kHz] BPF
Input Referred Noise Voltage	Vni	25°C	-	0.8	-	μVrms	RIAA, Rs=2.2 [kΩ], 30[kHz] LPF

(\*6) Absolute value

(\*7) Current direction: Since first input stage is composed with PNP transistor, input bias current flows out of IC.

● Absolute maximum rating (Ta=25[°C])  
OBA15218/BA14741F/BA15532 family

Parameter	Symbol	Rating			Unit
		BA15218 family	BA14741 family	BA15532 family	
Supply Voltage	VCC-VEE	36	36	42	V
Differential Input Voltage	Vid	VCC-VEE <sup>(*8)</sup>		±0.5 <sup>(*9)</sup>	V
Input Common-mode voltage range	Vicm	VEE~VCC			V
Operating Supply Voltage	Vopr	4~32 (±2~±16)	4~36 (±2~±18)	6~40 (±3~±20)	V
Input Current	li	-	-	±10	mA
Operating Temperature	Topr	-40~+85		-20~+75	°C
Storage Temperature	Tstg	-55~+125			°C
Maximum junction Temperature	Tjmax	125			°C
Output Short Current (*10)	Iomax	±50	-	-	mA
Output Short Time (*10)	Ts	-	unlimited (only 1CH short)	unlimited	Sec

Note: Absolute maximum rating item indicates the condition which must not be exceeded.

Application of voltage in excess of absolute maximum rating or use out absolute maximum rated temperature environment may cause deterioration of characteristics.

(\*8) The voltage difference between inverting input and non-inverting input is the differential input voltage. Then input terminal voltage is set to more than VEE.

(\*9) Don't over input current ±10mA. Built-in resistor for protection because of over current with differential input voltage above 0.5V.

(\*10) Limit within Pd

● Electrical characteristics

OBA15218 family (Unless otherwise specified VCC=+15[V], VEE=-15[V], Ta=25[°C])

Parameter	Symbol	Temperature Range	Guaranteed limit			Unit	Condition
			Min.	Typ.	Max.		
Input Offset Voltage <sup>(*11)</sup>	Vio	25°C	-	0.5	5.0	mV	Rs ≤ 10[kΩ]
Input Offset Current <sup>(*11)</sup>	lio	25°C	-	5	200	nA	-
Input Bias Current <sup>(*12)</sup>	Ib	25°C	-	50	500	nA	-
Large Single Voltage Gain	Av	25°C	86	110	-	dB	RL ≥ 2[kΩ], Vo = ±10[V]
Input Common-mode Voltage Range	Vicm	25°C	±12	±14	-	V	-
Common-mode Rejection Ratio	CMRR	25°C	70	90	-	dB	Rs ≤ 10[kΩ]
Power Supply Rejection Ratio	PSRR	25°C	76	90	-	dB	Rs ≤ 10[kΩ]
Supply Current	ICC	25°C	-	5.0	8.0	mA	Vin=0, RL=∞
Maximum Output Voltage	VOH	25°C	±12	±14	-	V	RL ≥ 10[kΩ]
	VOL	25°C	±10	±13	-	V	RL ≥ 2[kΩ]
Slew Rate	SR	25°C	-	3.0	-	V/μs	GV=0[dB], RL=2[kΩ]
Gain Bandwidth Product	GBW	25°C	-	10	-	MHz	f=10[kHz]
Input Referred Noise Voltage	Vn	25°C	-	1.0	-	μVrms	RS=1[kΩ], BW=20[Hz]~30[kHz], RIAA
Channel Separation	CS	25°C	-	120	-	dB	f=1[kHz] input referred

(\*11) Absolute value

(\*12) Current direction: Since first input stage is composed with PNP transistor, input bias current flows out of IC.

●Electrical characteristics

OBA14741 family (Unless otherwise specified VCC=+15[V], VEE=-15[V], Ta=25[°C])

Parameter	Symbol	Temperature Range	Guaranteed limit			Unit	Condition	
			Min.	Typ.	Max.			
Input Offset Voltage <sup>(*13)</sup>	Vio	25°C	-	1.0	5.0	mV	Rs ≤ 10[kΩ]	
Input Offset Current <sup>(*13)</sup>	Iio	25°C	-	10	50	nA	-	
Input Bias Current <sup>(*14)</sup>	Ib	25°C	-	60	300	nA	-	
Large Single Voltage Gain	Av	25°C	20	100	-	V/mV	RL ≥ 2[kΩ], Vo = ±10[V]	
Common-mode Rejection Ratio	CMRR	25°C	80	100	-	dB	-	
Input Common-mode Voltage Range	Vicm	25°C	±12	±13.5	-	V	-	
Power Supply Rejection Ratio	PSRR	25°C	80	100	-	dB	-	
Supply Current	ICC	25°C	-	3.0	7.0	mA	RL = ∞, on all OpAmp	
Maximum Output Voltage	High	VOH	25°C	10	12.5	-	V	Vin+ = 1[V], Vin- = 0[V], RL = 2[kΩ]
	Low	VOL	25°C	-10	-12.5	-	V	Vin+ = 0[V], Vin- = 1[V], RL = 2[kΩ]
Maximum Output Current	Source	IOH	25°C	10	20	-	mA	Vin+ = 1[V], Vin- = 0[V], VO = 0[V]
	Sink	IOL	25°C	5	10	-	mA	Vin+ = 0[V], Vin- = 1[V], VO = 0[V]
Slew Rate	SR	25°C	-	1.0	-	V/μs	Av = 1, RL = 2[kΩ]	
Input Referred Noise Voltage	Vn	25°C	-	2.0	4.0	μVrms	RIAA, Rs = 2.2[kΩ], 10[Hz] ~ 30[kHz]	
Channel Separation	CS	25°C	-	100	-	dB	f = 1[kHz] input referred	

(\*13) Absolute value

(\*14) Current direction: Since first input stage is composed with PNP transistor, input bias current flows out of IC.

●Electrical characteristics

OBA15532 family (Unless otherwise specified VCC=+15[V], VEE=-15[V], Ta=25[°C])

Parameter	Symbol	Temperature Range	Guaranteed limit			Unit	Condition
			Min.	Typ.	Max.		
Input Offset Voltage <sup>(*15)</sup>	Vio	25°C	-	0.5	4.0	mV	Rs = 50[Ω], RL ≥ 10[kΩ]
Input Offset Current <sup>(*15)</sup>	Iio	25°C	-	10	150	nA	RL ≥ 10[kΩ]
Input Bias Current <sup>(*16)</sup>	Ib	25°C	-	200	800	nA	RL ≥ 10[kΩ]
Large Single Voltage Gain	Av	25°C	80	94	-	dB	RL ≥ 600[Ω], Vo = ±10[V]
Common-mode Rejection Ratio	CMRR	25°C	70	100	-	dB	RL ≥ 10[kΩ]
Input Common-mode Voltage Range	Vicm	25°C	±12	±13	-	V	RL ≥ 10[kΩ]
Power Supply Rejection Ratio	PSRR	25°C	80	100	-	dB	Rs = 50[Ω], RL ≥ 10[kΩ]
Supply Current	Icc	25°C	-	8.0	16.0	mA	RL = ∞, on all OpAmp
Maximum Output Voltage -1	VOH/ VOL	25°C	±12	±13	-	V	RL ≥ 600[Ω]
Maximum Output Voltage -2		25°C	±15	±16	-	V	RL ≥ 600[Ω] VCC = 18[V], VEE = -18[V]
Output Short Current	IOS	25°C	-	38	-	mA	(*17)
Slew Rate	SR	25°C	-	8.0	-	V/μs	Av = 1, RL = 600[Ω], CL = 100[pF]
Gain Bandwidth Product	GBW	25°C	-	20	-	MHz	f = 10[kHz], RL = 600[Ω], CL = 100[pF]
Input Referred Noise Voltage	Vn	25°C	-	0.7	1.5	μVrms	RIAA, Rs = 100[Ω], 20[Hz] ~ 30[kHz]
Channel Separation	CS	25°C	-	110	-	dB	RIAA Input referred

(\*15) Absolute value

(\*16) Current direction: Since first input stage is composed with NPN transistor, input bias current flows out of IC.

(\*17) In the case of output pin shorting with VCC or VEE. But never over the maximum power dissipation

●Absolute maximum rating (Ta=25[°C])  
OBA4510/BA2115 family

Parameter	Symbol	Rating		Unit
		BA4510 family	BA2115 family	
Supply Voltage	VCC-VEE	10	14	V
Differential Input Voltage <sup>(*18)</sup>	Vid	VCC-VEE	14	V
Input Common-mode Voltage Range	Vicm	VEE~VCC	(VEE-0.3)~VEE+14	V
Operating Supply Voltage	Vopr	2~7(±1~±3.5)	2~14(±1~±7)	V
Operating Temperature	Topr	-20~+75	-40~+85	°C
Storage Temperature	Tstg	-55~125	-55~150	°C
Maximum Junction Temperature	Tjmax	125	150	°C

Note: Absolute maximum rating item indicates the condition which must not be exceeded.

Application of voltage in excess of absolute maximum rating or use out absolute maximum rated temperature environment may cause deterioration of characteristics.

(\*18) The voltage difference between inverting input and non-inverting input is the differential input voltage.  
Then input terminal voltage is set to more than VEE.

●Electrical characteristics

OBA4510 family (Unless otherwise specified VCC=+2.5[V], VEE=-2.5[V], Ta=25[°C])

Parameter	Symbol	Temperature Range	Guaranteed limit			Unit	Condition
			Min.	Typ.	Max.		
Input Offset Voltage <sup>(*19)</sup>	Vio	25°C	-	1	6	mV	Rs=50[Ω]
Input Offset Current <sup>(*19)</sup>	Iio	25°C	-	2	200	nA	-
Input Bias Current <sup>(*20)</sup>	Ib	25°C	-	80	500	nA	-
Supply Current	ICC	25°C	2.5	5.0	7.5	mA	RL=∞ All Op-Amps
Maximum Output Voltage	VOH	25°C	+2.0	+2.4	-	V	RL=10[kΩ]
	VOL	25°C	-	-2.4	-2.0	V	RL=10[kΩ]
Large Single Voltage Gain	Av	25°C	60	90	-	dB	RL ≥ 10[kΩ]
Input Common-mode Voltage Range	Vicm	25°C	-1.3	-	+1.5	V	-
Common-mode Rejection Ratio	CMRR	25°C	60	80	-	dB	-
Power Supply Rejection Ratio	PSRR	25°C	60	80	-	dB	Rs=50[Ω]
Slew Rate	SR	25°C	-	5.0	-	V/μs	Av=1

(\*19) Absolute value

(\*20) Current direction: Since first input stage is composed with PNP transistor, input bias current flows out of IC.

●Electrical characteristics

OBA2115 family (Unless otherwise specified VCC=+2.5[V], VEE=-2.5[V], Ta=25[°C])

Parameter	Symbol	Temperature Range	Guaranteed limit			Unit	Condition
			Min.	Typ.	Max.		
Input Offset Voltage <sup>(*21)</sup>	Vio	25°C	-	1	6	mV	VOUT=0[V], Vicm=0[V]
Input Offset Current <sup>(*21)</sup>	Iio	25°C	-	2	200	nA	VOUT=0[V], Vicm=0[V]
Input Bias Current <sup>(*22)</sup>	Ib	25°C	-	150	400	nA	VOUT=0[V], Vicm=0[V]
Supply Current	ICC	25°C	-	3.5	5	mA	RL=∞ All Op-Amps, VIN+=0[V]
Maximum Output Voltage	VOM	25°C	±2.0	±2.2	-	V	RL ≥ 2.5[kΩ]
Large Single Voltage Gain	AV	25°C	60	80	-	dB	RL ≥ 10[kΩ], VOUT=±2[V], Vicm=0[V]
Input Common-mode Voltage Range	Vicm	25°C	±1.5	-	-	V	-
Common-mode Rejection Ratio	CMRR	25°C	60	74	-	dB	Vicm=-1.5[V]~+1.5[V]
Power Supply Rejection Ratio	PSRR	25°C	60	80	-	dB	VCC=+2[V]~+14[V]
Slew Rate	SR	25°C	-	4	-	V/μs	AV=0[dB], VIN=±1[V]
Gain Bandwidth Product	GB	25°C	-	12	-	MHz	f=10[kHz]

(\*21) Absolute value

(\*22) Current direction: Since first input stage is composed with PNP transistor, input bias current flows out of IC.

● Example of electrical characteristics

○ BA4558 family

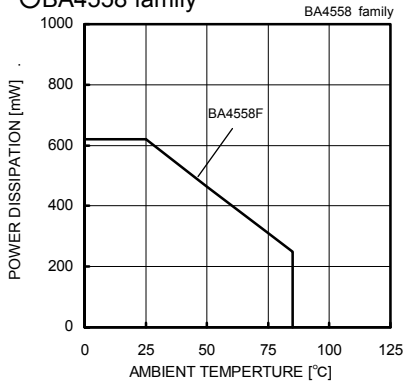

Fig. 1 Derating Curve

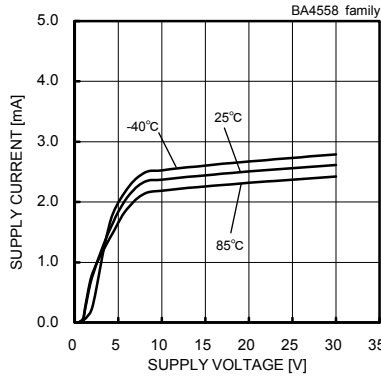

Fig. 2 Supply Current - Supply Voltage

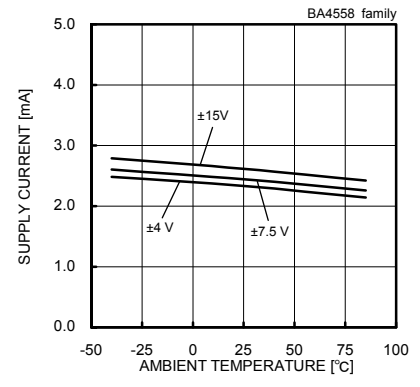

Fig. 3 Supply Current - Ambient Temperature

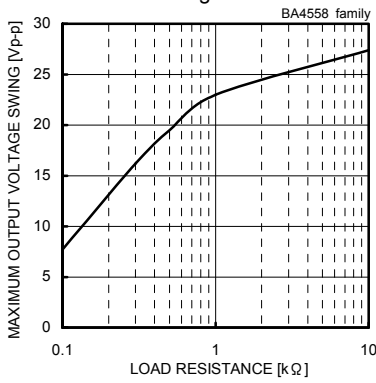

Fig. 4 Maximum Output Voltage Swing - Load Resistance  
(VCC/VEE=+15[V]/-15[V], Ta=25[°C])

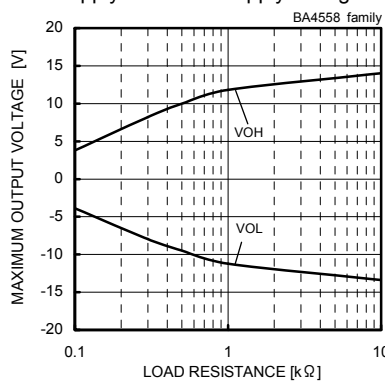

Fig. 5 Maximum Output Voltage - Load Resistance  
(VCC/VEE=+15[V]/-15[V], Ta=25[°C])

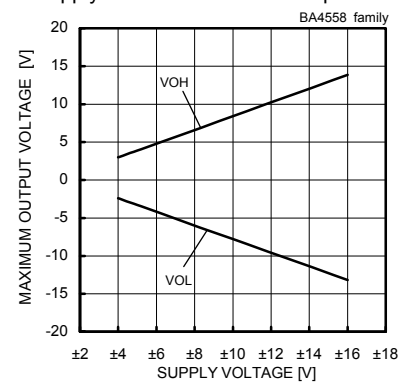

Fig. 6 Maximum Output Voltage - Supply Voltage  
(RL=2[kΩ], Ta=25[°C])

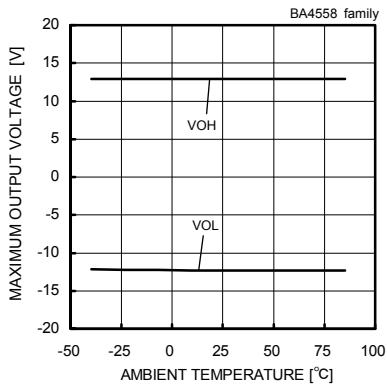

Fig. 7 Maximum Output Voltage - Ambient Temperature  
(VCC/VEE=+15[V]/-15[V], RL=2[kΩ])

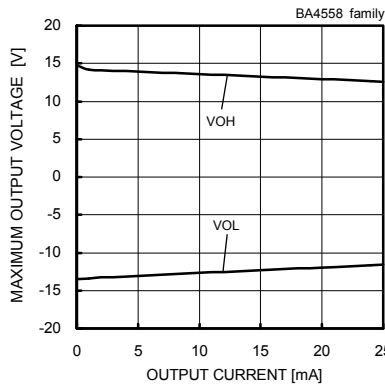

Fig. 8 Maximum Output Voltage - Output Current  
(VCC/VEE=+15[V]/-15[V], Ta=25[°C])

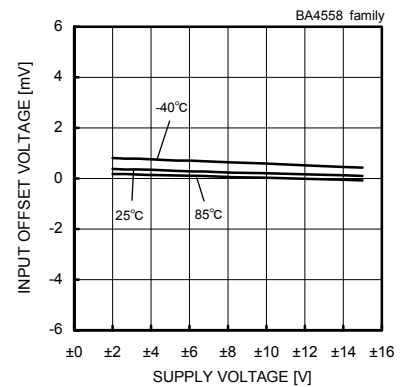

Fig. 9 Input Offset Voltage - Supply Voltage  
(Vicm=0[V], Vout=0[V])

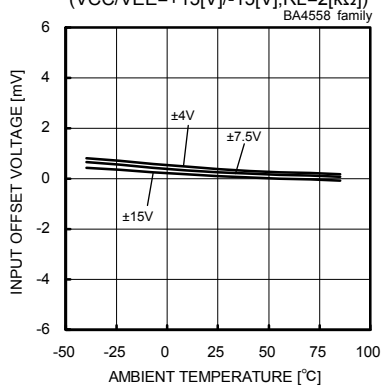

Fig. 10 Input Offset Voltage - Ambient Temperature  
(Vicm=0[V], Vout=0[V])

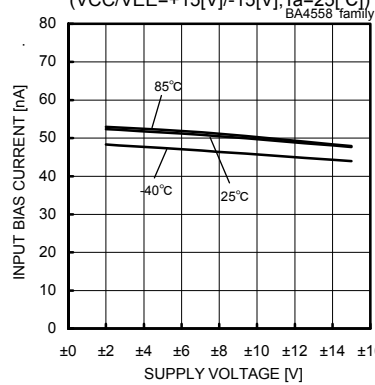

Fig. 11 Input Bias Current - Supply Voltage  
(Vicm=0[V], Vout=0[V])

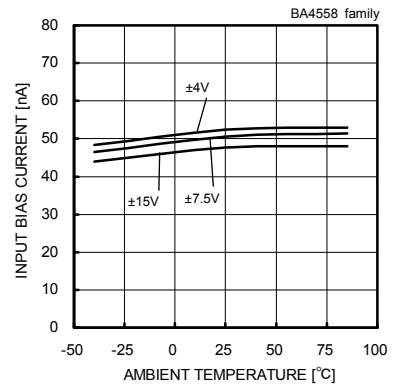

Fig. 12 Input Bias Current - Ambient Temperature  
(Vicm=0[V], Vout=0[V])

(\*) The above data is ability value of sample, it is not guaranteed.

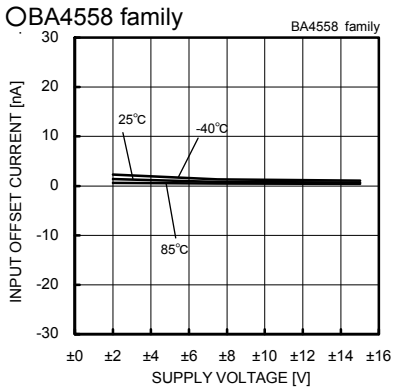

Fig. 13  
Input Offset Current – Supply Voltage  
( $V_{icm}=0[V]$ ,  $V_{out}=0[V]$ )

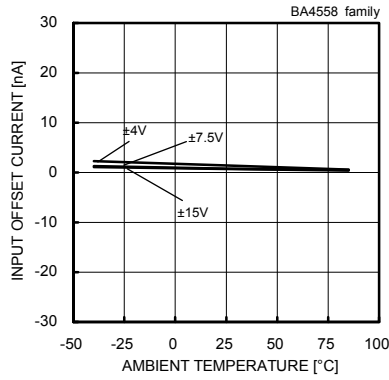

Fig. 14  
Input Offset Current – Ambient Temperature  
( $V_{icm}=0[V]$ ,  $V_{out}=0[V]$ )

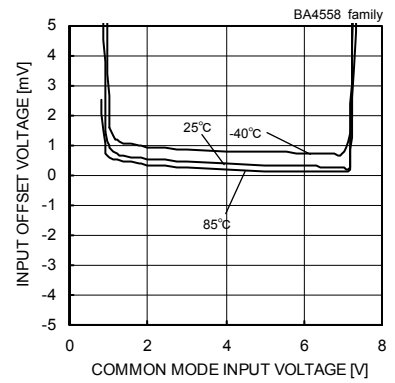

Fig. 15  
Input Offset Voltage  
– Common Mode Input Voltage  
( $V_{CC}=8[V]$ ,  $V_{out}=4[V]$ )

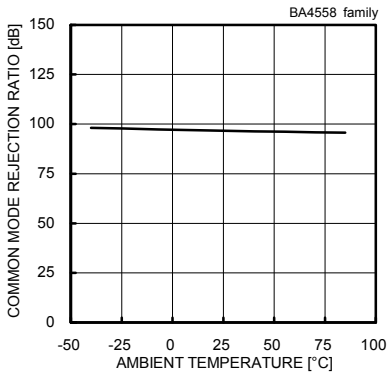

Fig. 16  
Common Mode Rejection Ratio  
– Ambient Temperature  
( $V_{CC}/V_{EE}=+15[V]/-15[V]$ ,  $V_{icm}=-12[V]$  to  $+12[V]$ )

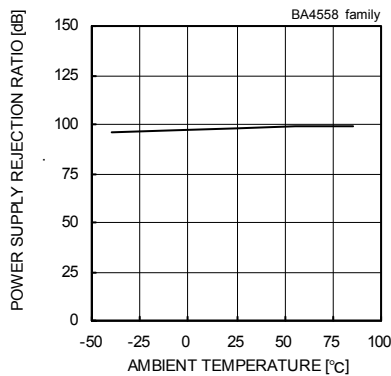

Fig. 17  
Power Supply Rejection Ratio  
– Ambient Temperature  
( $V_{CC}/V_{EE}=+4[V]/-4[V]$  to  $+15[V]/-15[V]$ )

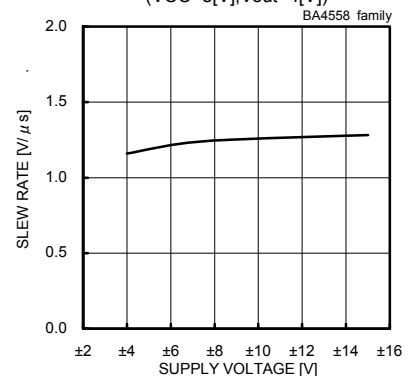

Fig. 18  
Slew Rate – Supply Voltage  
( $C_L=100[pF]$ ,  $R_L=2[k\Omega]$ ,  $T_a=25[^\circ C]$ )

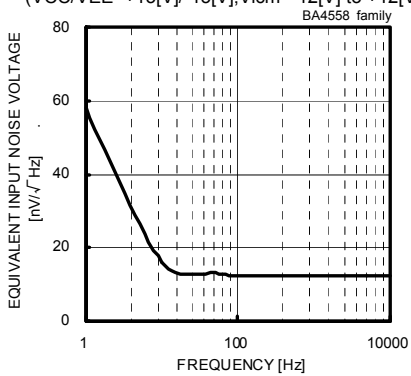

Fig. 19  
Equivalent Input Noise Voltage – Frequency  
( $V_{CC}/V_{EE}=+15[V]/-15[V]$ ,  $R_s=100[\Omega]$ ,  $T_a=25[^\circ C]$ )

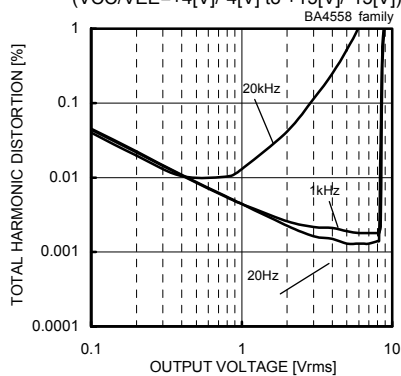

Fig. 20  
Total Harmonic Distortion – Output Voltage  
( $V_{CC}/V_{EE}=+15[V]/-15[V]$ ,  $A_v=20[dB]$ ,  $R_L=2[k\Omega]$ ,  $80[kHz]$ -LPF,  $T_a=25[^\circ C]$ )

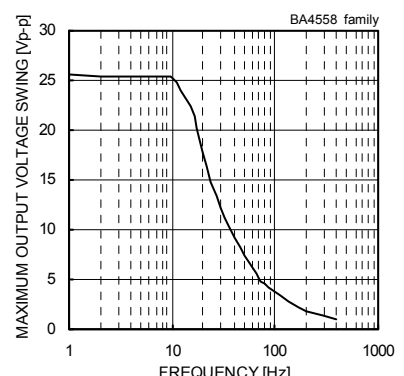

Fig. 21  
Maximum Output Voltage Swing – Frequency  
( $V_{CC}/V_{EE}=+15[V]/-15[V]$ ,  $R_L=2[k\Omega]$ ,  $T_a=25[^\circ C]$ )

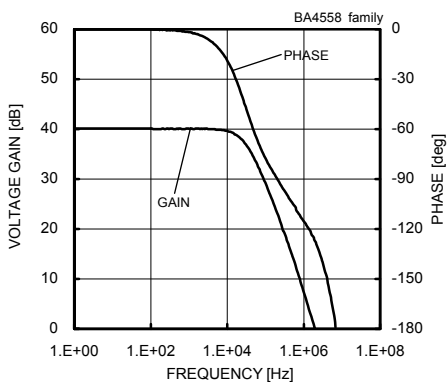

Fig. 22  
Voltage Gain – Frequency  
( $V_{CC}/V_{EE}=+15[V]/-15[V]$ ,  $A_v=40[dB]$ ,  $R_L=2[k\Omega]$ ,  $T_a=25[^\circ C]$ )

(\*) The above data is ability value of sample, it is not guaranteed.



OBA4560 family

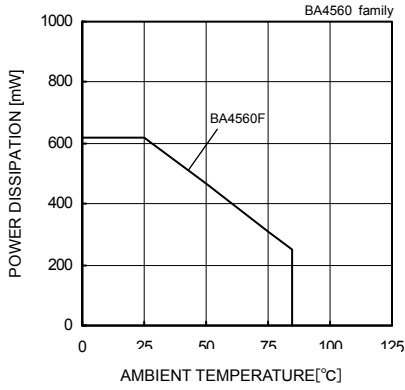

Fig. 23

Derating Curve

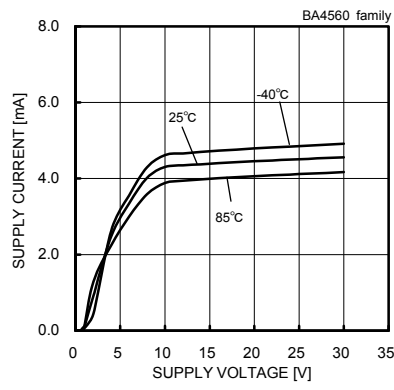

Fig. 24

Supply Current – Supply Voltage

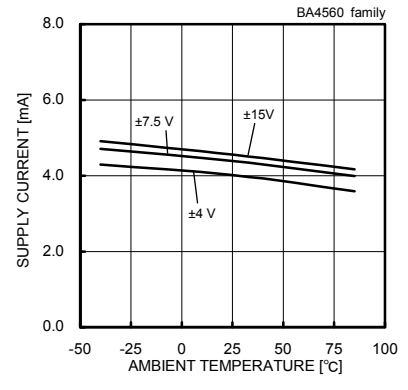

Fig. 25

Supply Current – Ambient Temperature

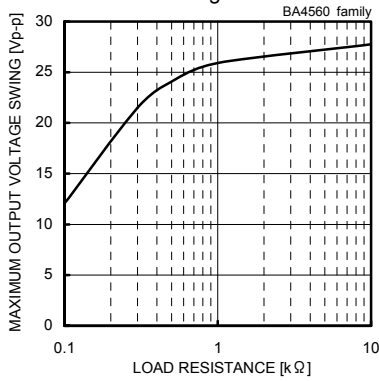

Fig. 26

Maximum Output Voltage Swing – Load Resistance  
(VCC/VEE=+15[V]/-15[V], Ta=25[°C])

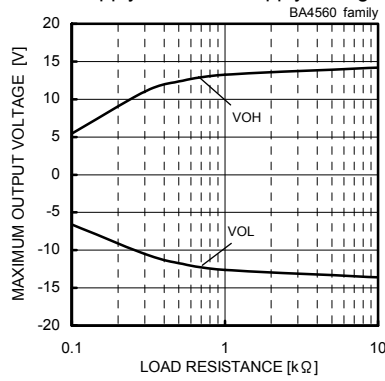

Fig. 27

Maximum Output Voltage – Load Resistance  
(VCC/VEE=+15[V]/-15[V], Ta=25[°C])

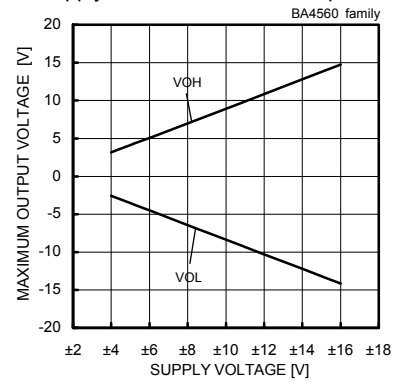

Fig. 28

Maximum Output Voltage – Supply Voltage  
(RL=2[kΩ], Ta=25[°C])

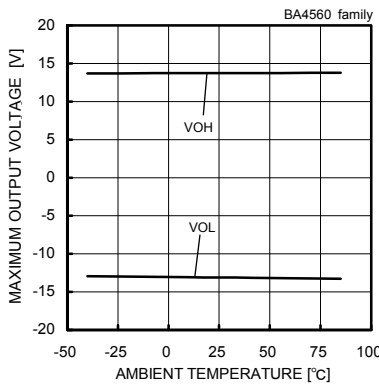

Fig. 29

Maximum Output Voltage – Ambient Temperature  
(VCC/VEE=+15[V]/-15[V], RL=2[kΩ])

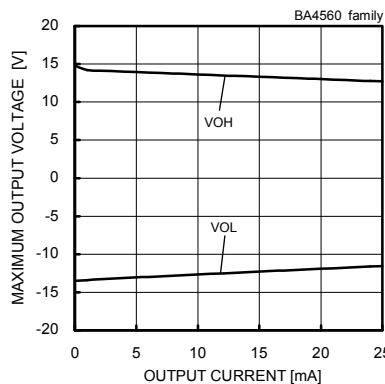

Fig. 30

Maximum Output Voltage – Output Current  
(VCC/VEE=+15[V]/-15[V], Ta=25[°C])

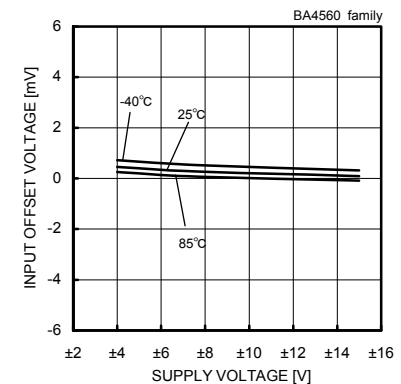

Fig. 31

Input Offset Voltage – Supply Voltage  
(Vcm=0[V], Vout=0[V])

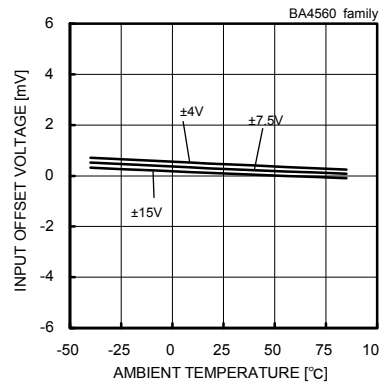

Fig. 32

Input Offset Voltage – Ambient Temperature  
(Vcm=0[V], Vout=0[V])

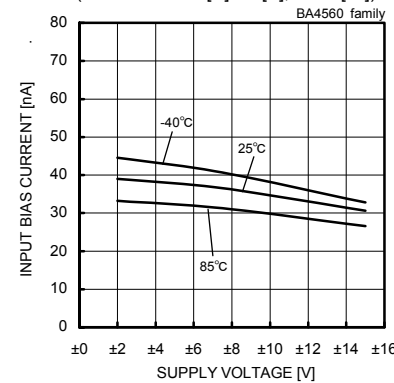

Fig. 33

Input Bias Current – Supply Voltage  
(Vcm=0[V], Vout=0[V])

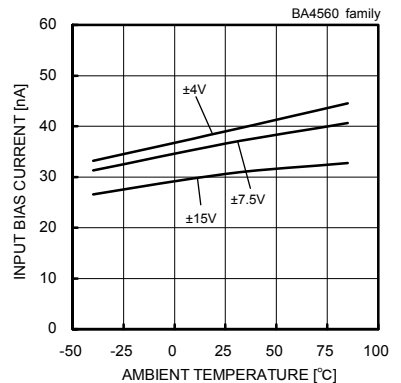

Fig. 34

Input Bias Current – Ambient Temperature  
(Vcm=0[V], Vout=0[V])

(\*) The above data is ability value of sample, it is not guaranteed.

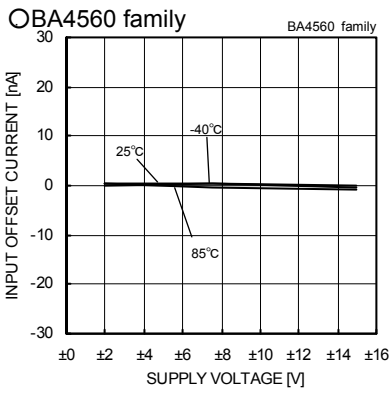

Fig. 35  
Input Offset Current – Supply Voltage  
( $V_{icm}=0[V]$ ,  $V_{out}=0[V]$ )

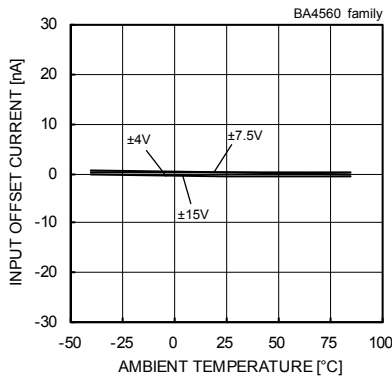

Fig. 36  
Input Offset Current – Ambient Temperature  
( $V_{icm}=0[V]$ ,  $V_{out}=0[V]$ )

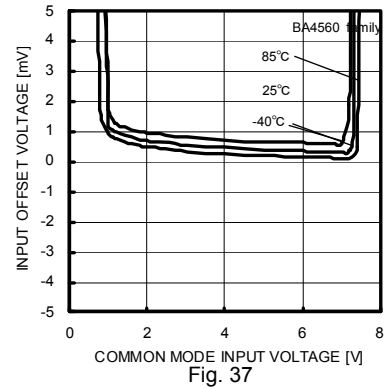

Fig. 37  
Input Offset Voltage  
– Common Mode Input Voltage  
( $V_{CC}=8[V]$ ,  $V_{out}=4[V]$ )

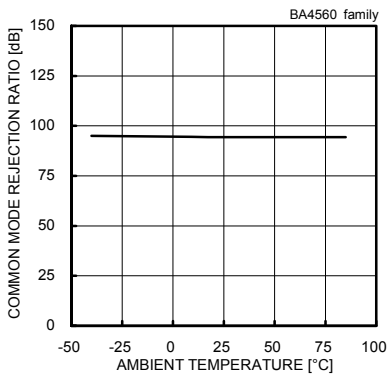

Fig. 38  
Common Mode Rejection Ratio  
– Ambient Temperature  
( $V_{CC}/V_{EE}=+15[V]/-15[V]$ ,  $V_{icm}=-12[V]$  to  $+12[V]$ )

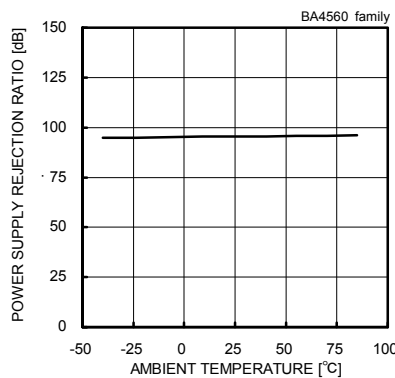

Fig. 39  
Power Supply Rejection Ratio  
– Ambient Temperature  
( $V_{CC}/V_{EE}=+4[V]/-4[V]$  to  $+15[V]/-15[V]$ )

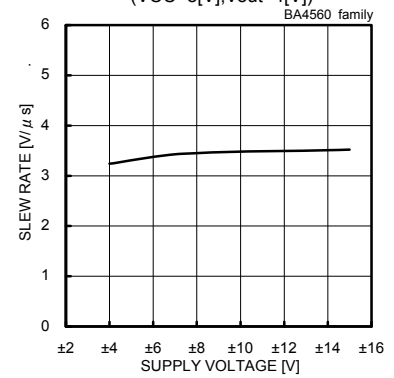

Fig. 40  
Slew Rate – Supply Voltage  
( $C_L=100[pF]$ ,  $R_L=2[k\Omega]$ ,  $T_a=25[^\circ C]$ )

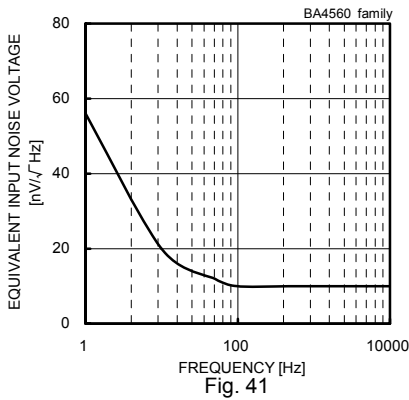

Fig. 41  
Equivalent Input Noise Voltage – Frequency  
( $V_{CC}/V_{EE}=+15[V]/-15[V]$ ,  $R_s=100[\Omega]$ ,  $T_a=25[^\circ C]$ )

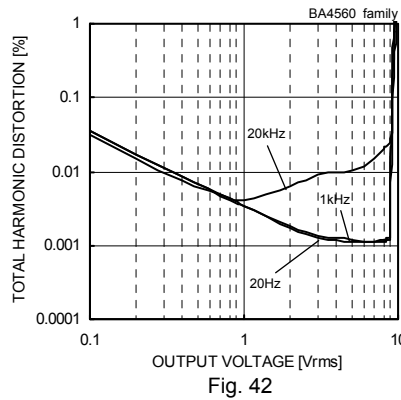

Fig. 42  
Total Harmonic Distortion – Output Voltage  
( $V_{CC}/V_{EE}=+15[V]/-15[V]$ ,  $A_v=20[dB]$ ,  
 $R_L=2[k\Omega]$ ,  $80[kHz]$ -LPF,  $T_a=25[^\circ C]$ )

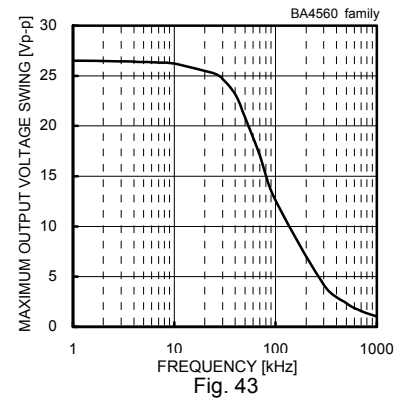

Fig. 43  
Maximum Output Voltage Swing – Frequency  
( $V_{CC}/V_{EE}=+15[V]/-15[V]$ ,  $R_L=2[k\Omega]$ ,  $T_a=25[^\circ C]$ )

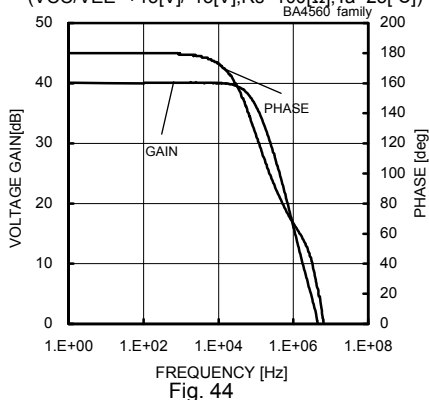

Fig. 44  
Voltage Gain – Frequency  
( $V_{CC}/V_{EE}=+15[V]/-15[V]$ ,  $A_v=40[dB]$ ,  $R_L=2[k\Omega]$ ,  $T_a=25[^\circ C]$ )

(\*) The above data is ability value of sample, it is not guaranteed.

OBA4558R family

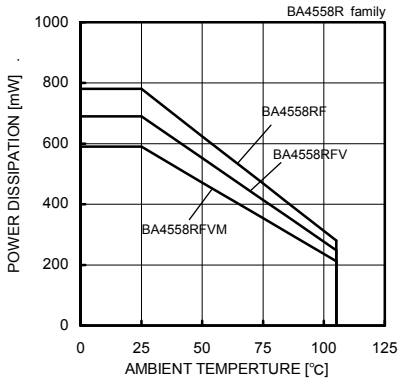

Fig. 45  
Derating Curve

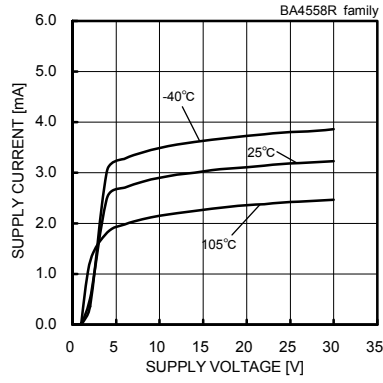

Fig. 46  
Supply Current - Supply Voltage

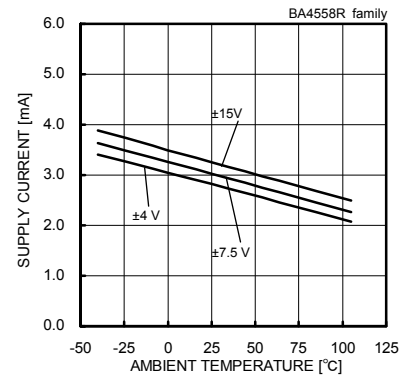

Fig. 47  
Supply Current - Ambient Temperature

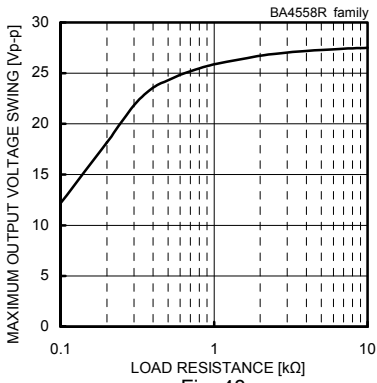

Fig. 48  
Maximum Output Voltage Swing  
- Load Resistance  
(VCC/VEE=+15[V]/-15[V], Ta=25[°C])

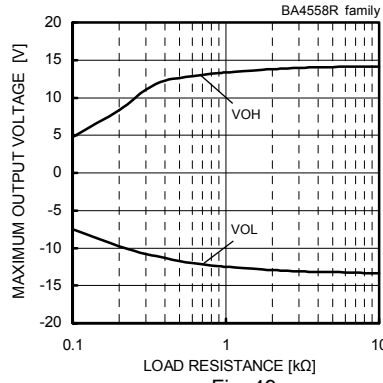

Fig. 49  
Maximum Output Voltage  
- Load Resistance  
(VCC/VEE=+15[V]/-15[V], Ta=25[°C])

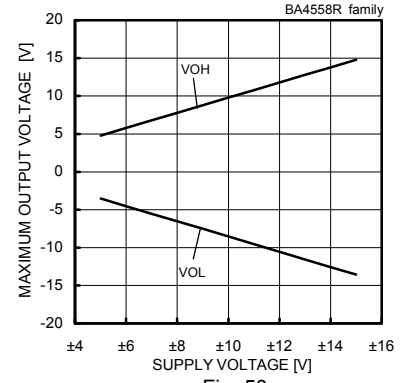

Fig. 50  
Maximum Output Voltage  
- Supply Voltage  
(RL=2[kΩ], Ta=25[°C])

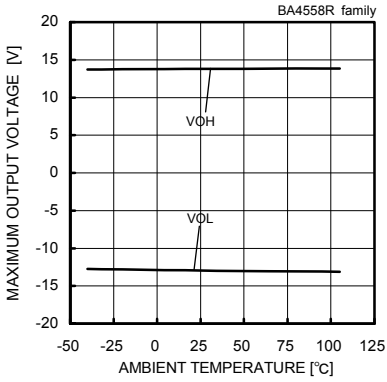

Fig. 51  
Maximum Output Voltage  
- Ambient Temperature  
(VCC/VEE=+15[V]/-15[V], RL=2[kΩ])

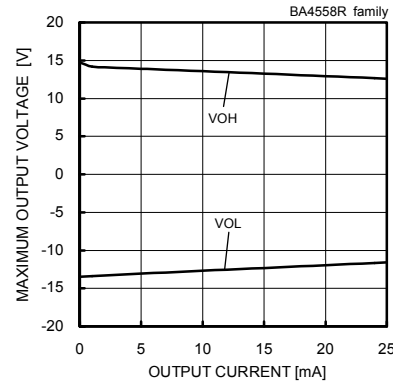

Fig. 52  
Maximum Output Voltage  
- Output Current  
(VCC/VEE=+15[V]/-15[V], Ta=25[°C])

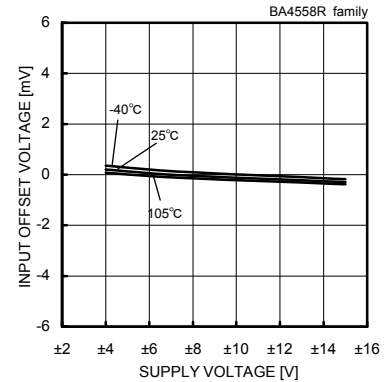

Fig. 53  
Input Offset Voltage - Supply Voltage  
(Vicm=0[V], Vout=0[V])

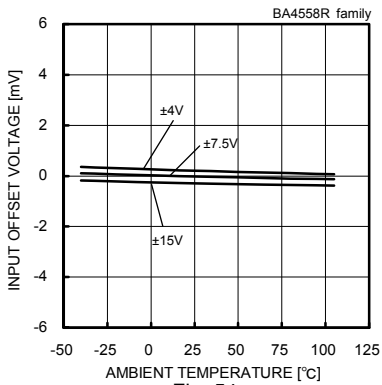

Fig. 54  
Input Offset Voltage - Ambient Temperature  
(Vicm=0[V], Vout=0[V])

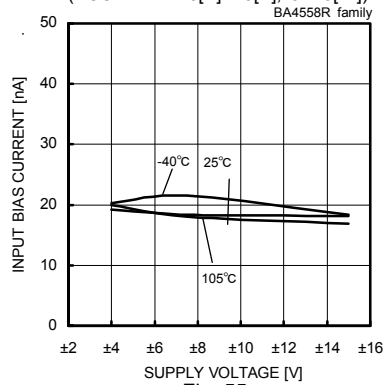

Fig. 55  
Input Bias Current - Supply Voltage  
(Vicm=0[V], Vout=0[V])

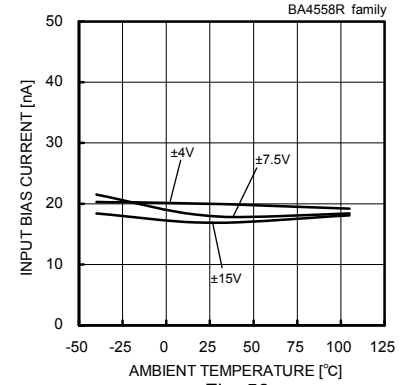

Fig. 56  
Input Bias Current - Ambient Temperature  
(Vicm=0[V], Vout=0[V])

(\* The above data is ability value of sample, it is not guaranteed.)

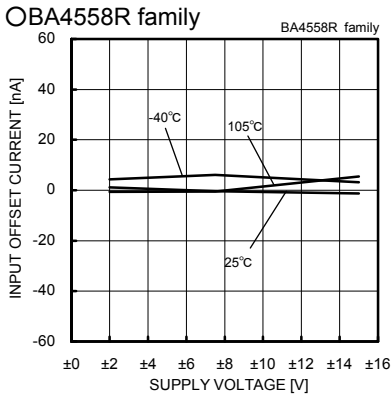

Fig. 57

Input Offset Current – Supply Voltage  
( $V_{icm}=0[V]$ ,  $V_{out}=0[V]$ )

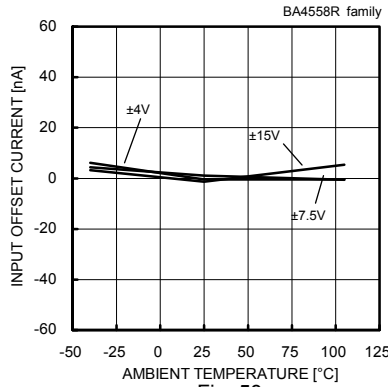

Fig. 58

Input Offset Current – Ambient Temperature  
( $V_{icm}=0[V]$ ,  $V_{out}=0[V]$ )

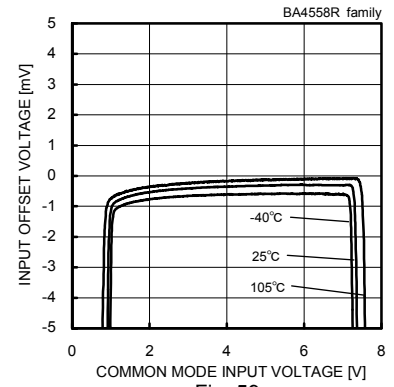

Fig. 59

Input Offset Voltage – Common Mode Input Voltage  
( $V_{CC}=8[V]$ ,  $V_{out}=4[V]$ )

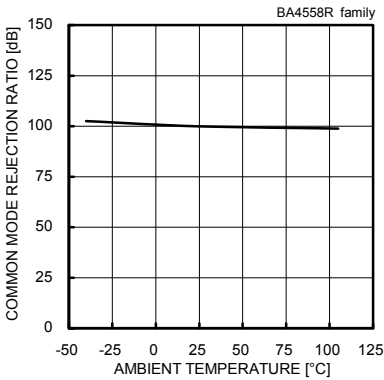

Fig. 60

Common Mode Rejection Ratio – Ambient Temperature  
( $V_{CC}/V_{EE}=+15[V]/-15[V]$ ,  $V_{icm}=-12[V]$  to  $+12[V]$ )

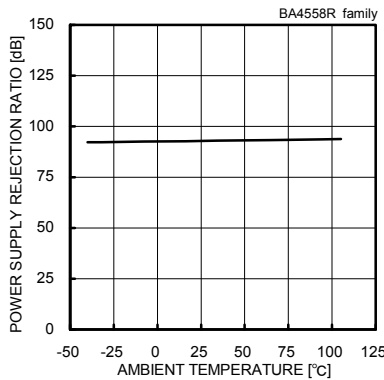

Fig. 61

Power Supply Rejection Ratio – Ambient Temperature  
( $V_{CC}/V_{EE}=+4[V]/-4[V]$  to  $+15[V]/-15[V]$ )

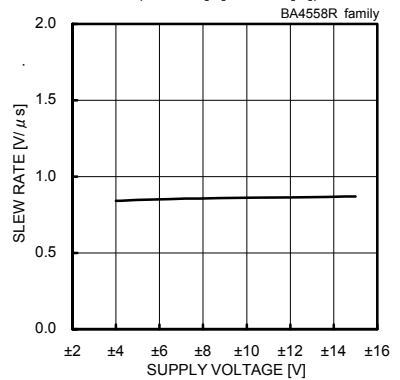

Fig. 62

Slew Rate – Supply Voltage  
( $C_L=100[pF]$ ,  $R_L=2[k\Omega]$ ,  $T_a=25[^\circ C]$ )

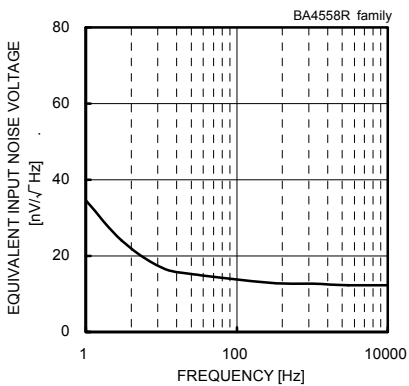

Fig. 63

Equivalent Input Noise Voltage – Frequency  
( $V_{CC}/V_{EE}=+15[V]/-15[V]$ ,  $R_s=100[\Omega]$ ,  $T_a=25[^\circ C]$ )

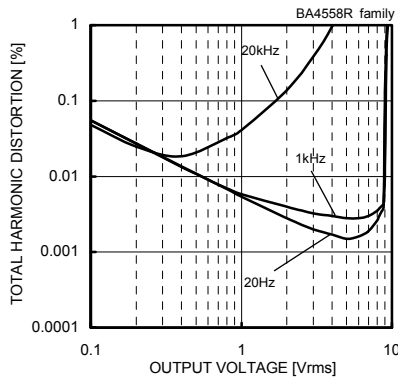

Fig. 64

Total Harmonic Distortion – Output Voltage  
( $V_{CC}/V_{EE}=+15[V]/-15[V]$ ,  $A_v=20[dB]$ ,  $R_L=2[k\Omega]$ ,  $80[kHz]$ -LPF,  $T_a=25[^\circ C]$ )

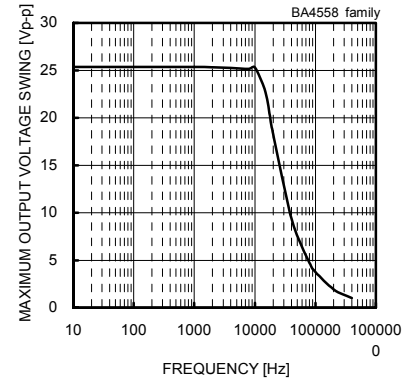

Fig. 65

Maximum Output Voltage Swing – Frequency  
( $V_{CC}/V_{EE}=+15[V]/-15[V]$ ,  $R_L=2[k\Omega]$ ,  $T_a=25[^\circ C]$ )

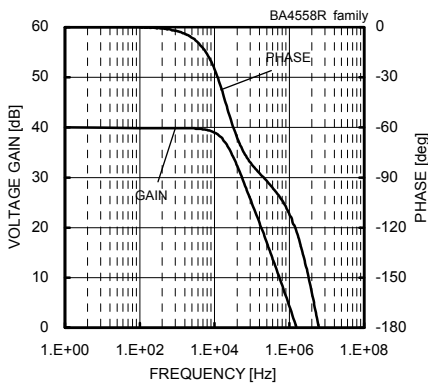

Fig. 66

Voltage Gain – Frequency  
( $V_{CC}/V_{EE}=+15[V]/-15[V]$ ,  $A_v=40[dB]$ ,  $R_L=2[k\Omega]$ ,  $T_a=25[^\circ C]$ )

(\*) The above data is ability value of sample, it is not guaranteed.

OBA4560R family

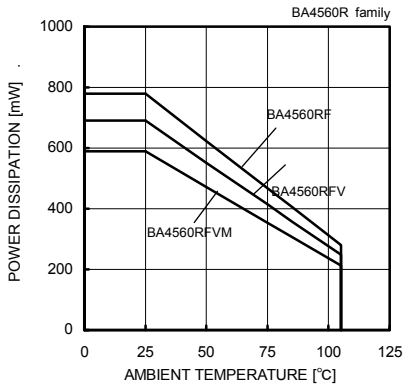

Fig. 67  
Derating Curve

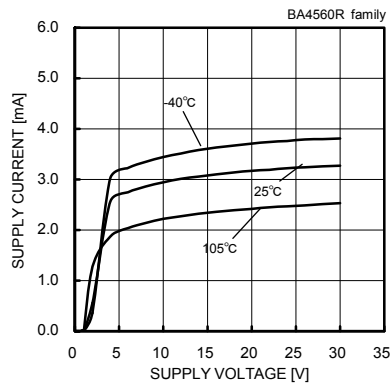

Fig. 68  
Supply Current – Supply Voltage

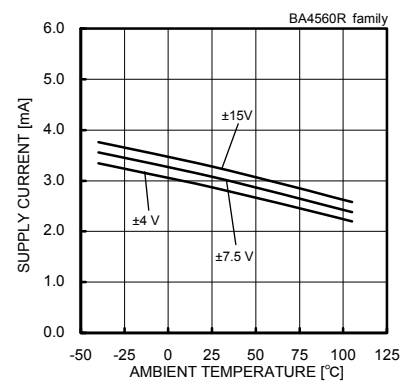

Fig. 69  
Supply Current – Ambient Temperature

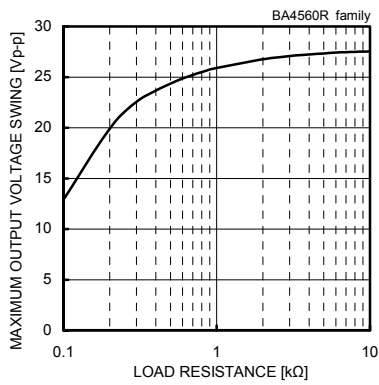

Fig. 70  
Maximum Output Voltage Swing  
– Load Resistance  
(VCC/VEE=+15[V]/-15[V], Ta=25°C)

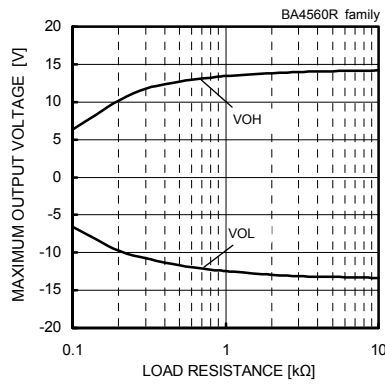

Fig. 71  
Maximum Output Voltage  
– Load Resistance  
(VCC/VEE=+15[V]/-15[V], Ta=25°C)

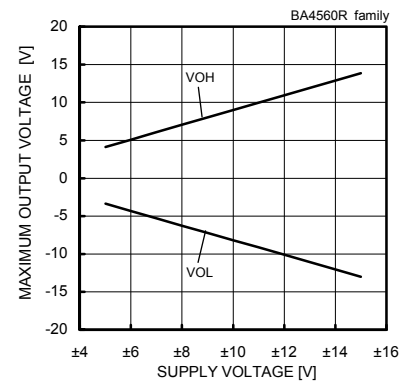

Fig. 72  
Maximum Output Voltage  
– Supply Voltage  
(RL=2[kΩ], Ta=25°C)

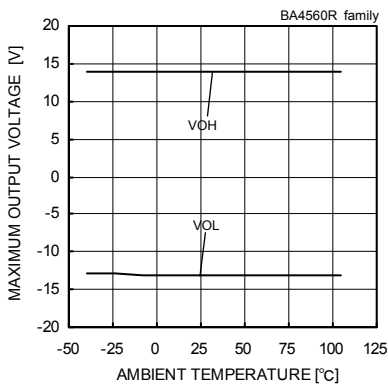

Fig. 73  
Maximum Output Voltage  
– Ambient Temperature  
(VCC/VEE=+15[V]/-15[V], RL=2[kΩ])

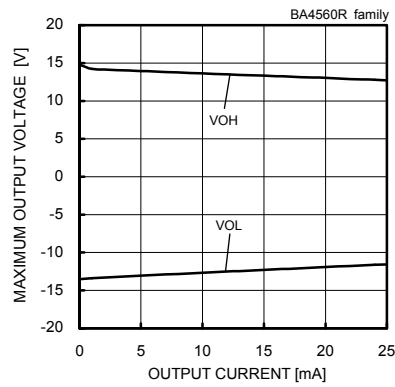

Fig. 74  
Maximum Output Voltage  
– Output Current  
(VCC/VEE=+15[V]/-15[V], Ta=25°C)

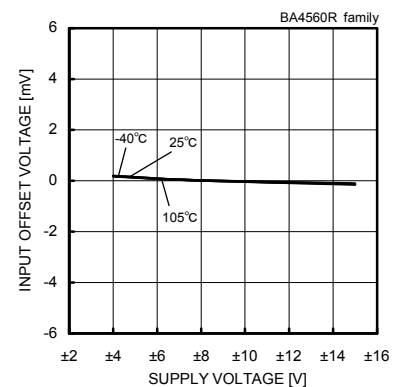

Fig. 75  
Input Offset Voltage – Supply Voltage  
(Vicm=0[V], Vout=0[V])

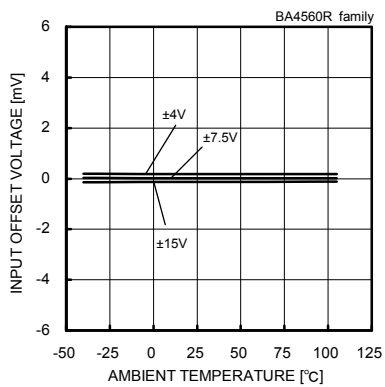

Fig. 76  
Input Offset Voltage – Ambient Temperature  
(Vicm=0[V], Vout=0[V])

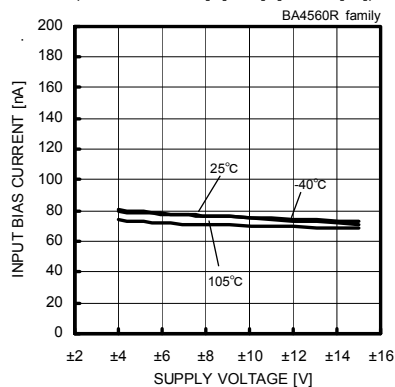

Fig. 77  
Input Bias Current – Supply Voltage  
(Vicm=0[V], Vout=0[V])

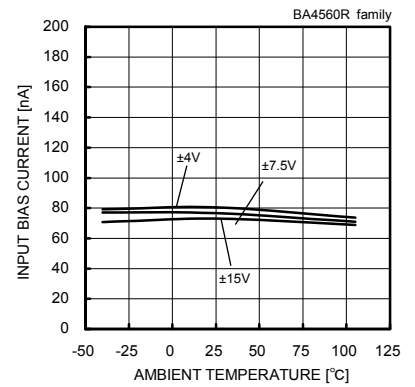

Fig. 78  
Input Bias Current – Ambient Temperature  
(Vicm=0[V], Vout=0[V])

(\*) The above data is ability value of sample, it is not guaranteed.

OBA4560R family

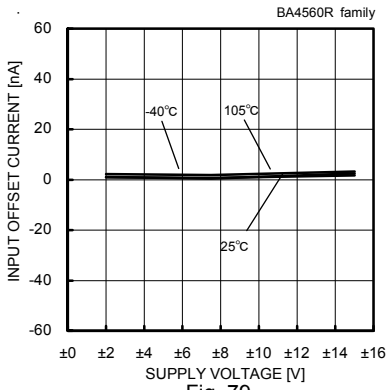

Fig. 79  
Input Offset Current – Supply Voltage  
( $V_{icm}=0[V]$ ,  $V_{out}=0[V]$ )

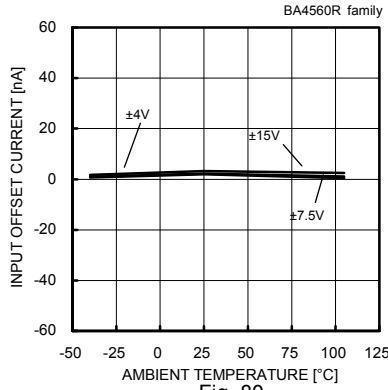

Fig. 80  
Input Offset Current – Ambient Temperature  
( $V_{icm}=0[V]$ ,  $V_{out}=0[V]$ )

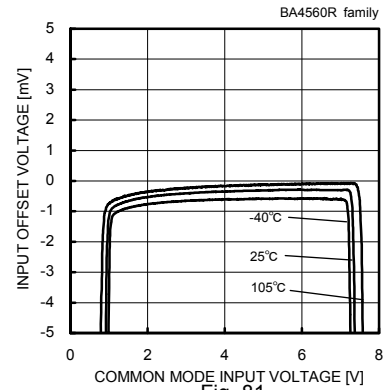

Fig. 81  
Input Offset Voltage  
- Common Mode Input Voltage  
( $V_{CC}=8[V]$ ,  $V_{out}=4[V]$ )

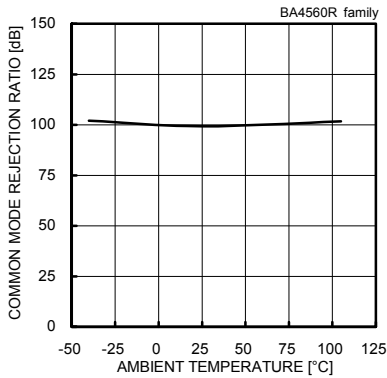

Fig. 82  
Common Mode Rejection Ratio  
– Ambient Temperature  
( $V_{CC}/V_{EE}=+15[V]/-15[V]$ ,  $V_{icm}=-12[V]$  to  $+12[V]$ )

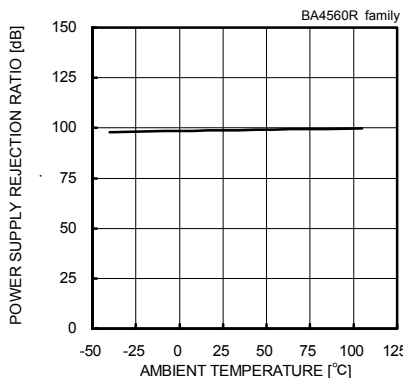

Fig. 83  
Power Supply Rejection Ratio  
– Ambient Temperature  
( $V_{CC}/V_{EE}=+4[V]/-4[V]$  to  $+15[V]/-15[V]$ )

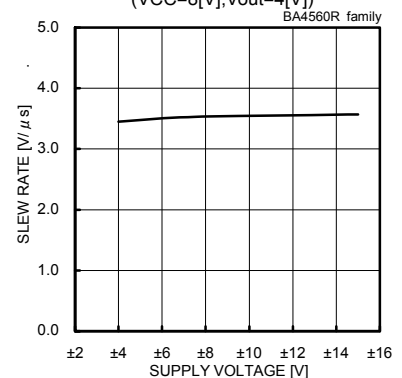

Fig. 84  
Slew Rate – Supply Voltage  
( $C_L=100[pF]$ ,  $R_L=2[k\Omega]$ ,  $T_a=25[^\circ C]$ )

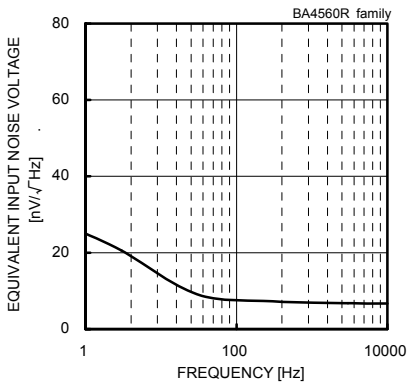

Fig. 85  
Equivalent Input Noise Voltage – Frequency  
( $V_{CC}/V_{EE}=+15[V]/-15[V]$ ,  $R_s=100[\Omega]$ ,  $T_a=25[^\circ C]$ )

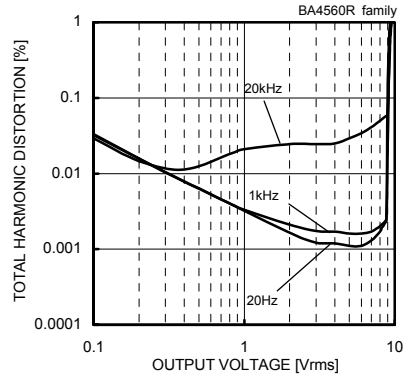

Fig. 86  
Total Harmonic Distortion – Output Voltage  
( $V_{CC}/V_{EE}=+15[V]/-15[V]$ ,  $A_v=20[dB]$ ,  
 $R_L=2[k\Omega]$ , 80[kHz]-LPF,  $T_a=25[^\circ C]$ )

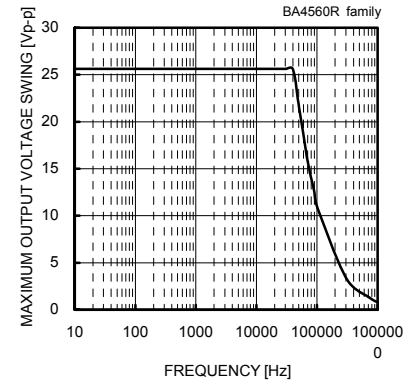

Fig. 87  
Maximum Output Voltage Swing – Frequency  
( $V_{CC}/V_{EE}=+15[V]/-15[V]$ ,  $R_L=2[k\Omega]$ ,  $T_a=25[^\circ C]$ )

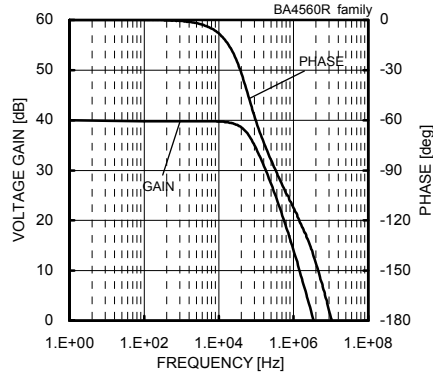

Fig. 88  
Voltage Gain – Frequency  
( $V_{CC}/V_{EE}=+15[V]/-15[V]$ ,  $A_v=40[dB]$ ,  $R_L=2[k\Omega]$ ,  $T_a=25[^\circ C]$ )

(\*) The above data is ability value of sample, it is not guaranteed.

OBA4580R family

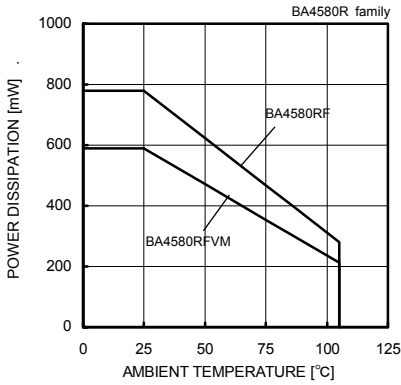

Fig. 89  
Derating Curve

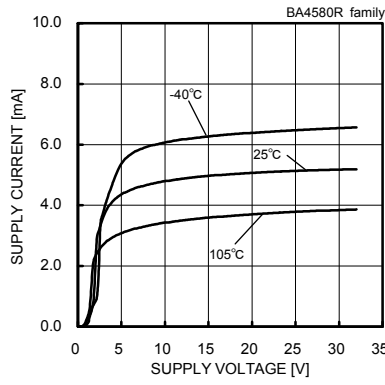

Fig. 90  
Supply Current - Supply Voltage

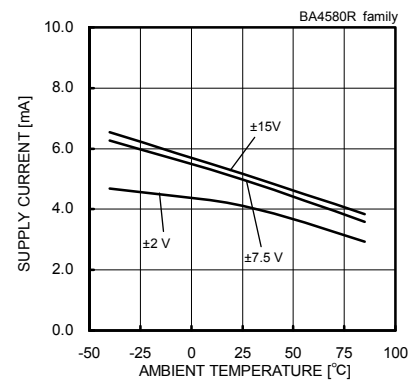

Fig. 91  
Supply Current - Ambient Temperature

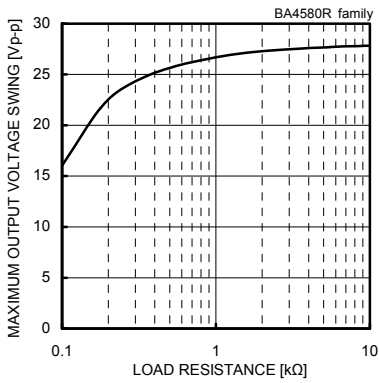

Fig. 92  
Maximum Output Voltage Swing  
- Load Resistance  
(VCC/VEE=+15[V]/-15[V], Ta=25[°C])

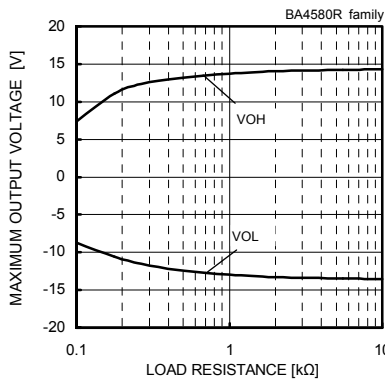

Fig. 93  
Maximum Output Voltage  
- Load Resistance  
(VCC/VEE=+15[V]/-15[V], Ta=25[°C])

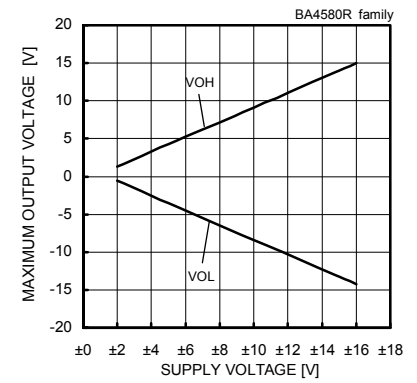

Fig. 94  
Maximum Output Voltage  
- Supply Voltage  
(RL=2[kΩ], Ta=25[°C])

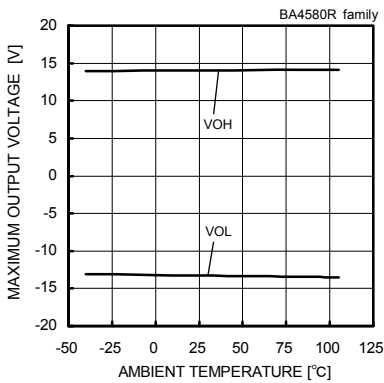

Fig. 95  
Maximum Output Voltage  
- Ambient Temperature  
(VCC/VEE=+15[V]/-15[V], RL=2[kΩ])

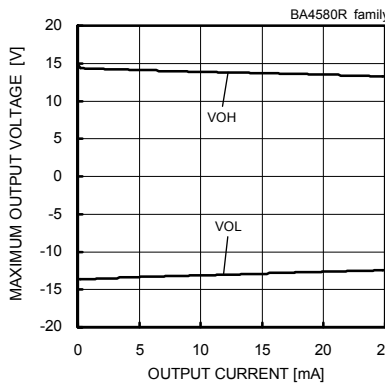

Fig. 96  
Maximum Output Voltage  
- Output Current  
(VCC/VEE=+15[V]/-15[V], Ta=25[°C])

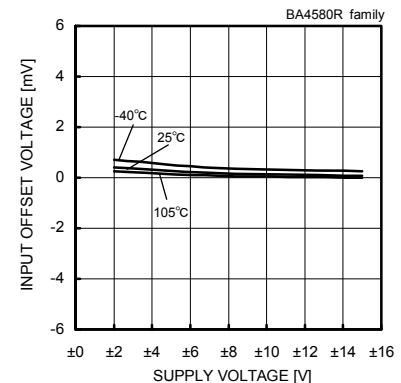

Fig. 97  
Input Offset Voltage - Supply Voltage  
(Vicm=0[V], Vout=0[V])

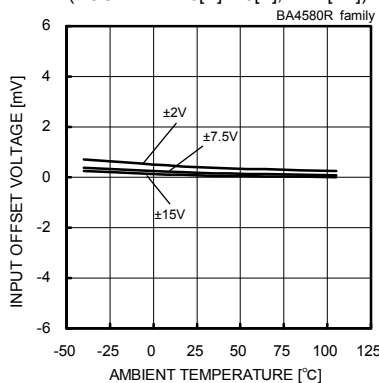

Fig. 98  
Input Offset Voltage - Ambient Temperature  
(Vicm=0[V], Vout=0[V])

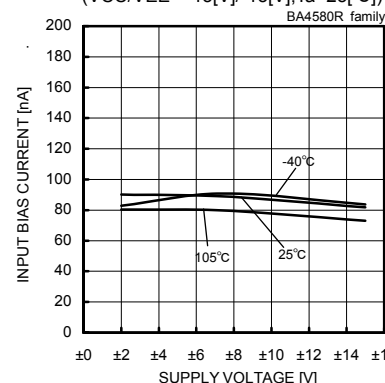

Fig. 99  
Input Bias Current - Supply Voltage  
(Vicm=0[V], Vout=0[V])

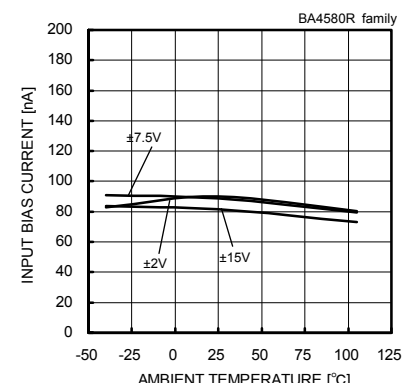

Fig. 100  
Input Bias Current - Ambient Temperature  
(Vicm=0[V], Vout=0[V])

(\* The above data is ability value of sample, it is not guaranteed.

OBA4580R family

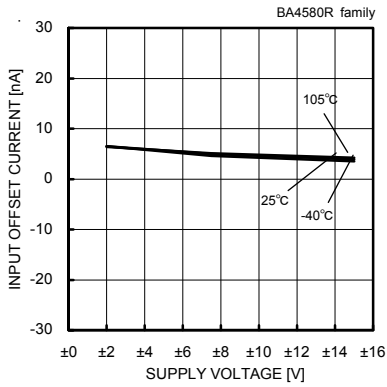

Fig. 101

Input Offset Current – Supply Voltage  
( $V_{icm}=0[V], V_{out}=0[V]$ )

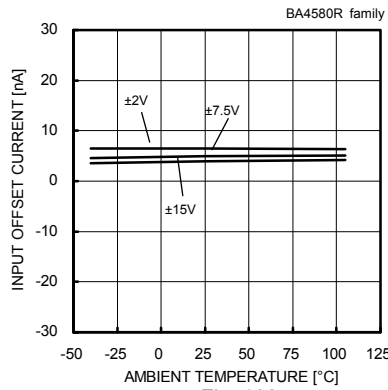

Fig. 102

Input Offset Current – Ambient Temperature  
( $V_{icm}=0[V], V_{out}=0[V]$ )

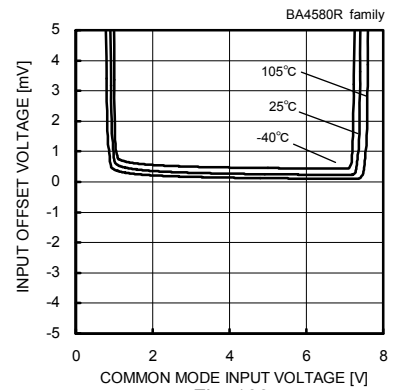

Fig. 103

Input Offset Voltage – Common Mode Input Voltage  
( $V_{CC}=8[V], V_{out}=4[V]$ )

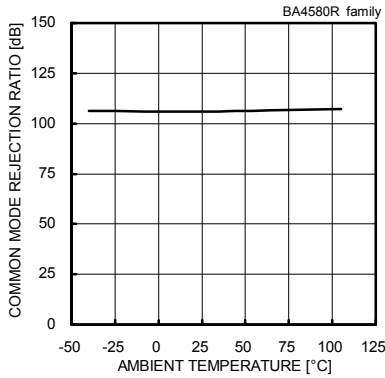

Fig. 104

Common Mode Rejection Ratio – Ambient Temperature  
( $V_{CC}/V_{EE}=+15[V]/-15[V], V_{icm}=-12[V]$  to  $+12[V]$ )

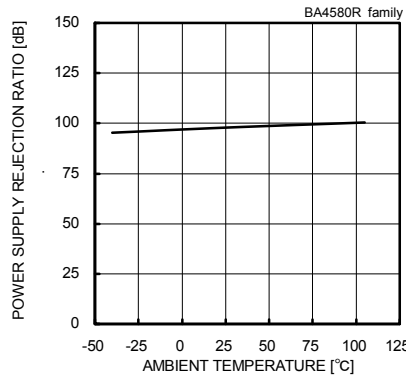

Fig. 105

Power Supply Rejection Ratio – Ambient Temperature  
( $V_{CC}/V_{EE}=+2[V]/-2[V]$  to  $+15[V]/-15[V]$ )

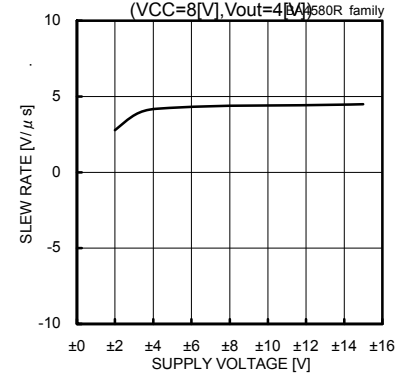

Fig. 106

Slew Rate – Supply Voltage  
( $C_L=100[pF], R_L=2[k\Omega], T_a=25[^\circ C]$ )

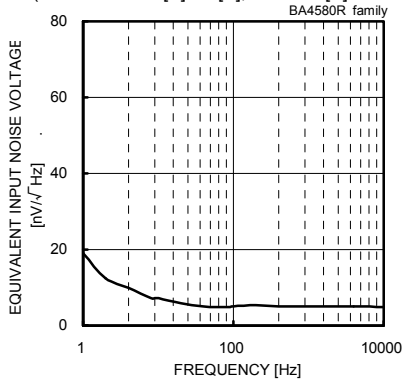

Fig. 107

Equivalent Input Noise Voltage – Frequency  
( $V_{CC}/V_{EE}=+15[V]/-15[V], R_s=100[\Omega], T_a=25[^\circ C]$ )

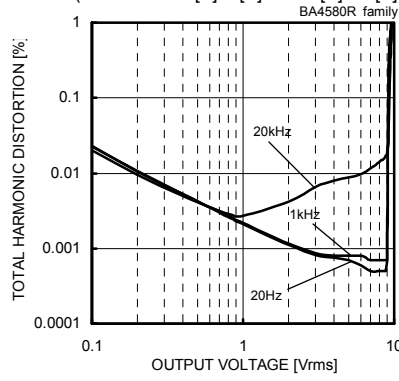

Fig. 108

Total Harmonic Distortion – Output Voltage  
( $V_{CC}/V_{EE}=+15[V]/-15[V], A_v=20[dB], R_L=2[k\Omega], 80[kHz]$ -LTPF,  $T_a=25[^\circ C]$ )

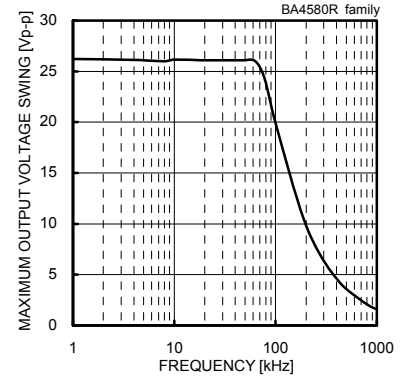

Fig. 109

Maximum Output Voltage Swing – Frequency  
( $V_{CC}/V_{EE}=+15[V]/-15[V], R_L=2[k\Omega], T_a=25[^\circ C]$ )

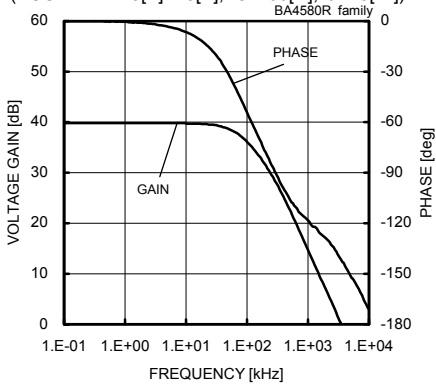

Fig. 110

Voltage Gain – Frequency  
( $V_{CC}/V_{EE}=+15[V]/-15[V], A_v=40[dB], R_L=2[k\Omega], T_a=25[^\circ C]$ )

(\* The above data is ability value of sample, it is not guaranteed.)



OBA15218 family

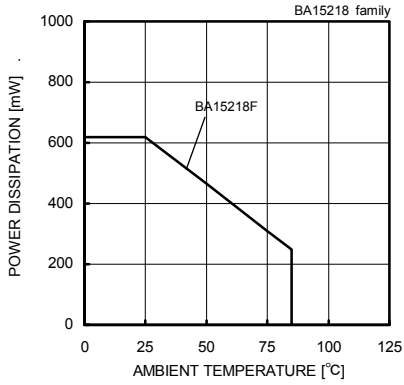

Fig. 111  
Derating Curve

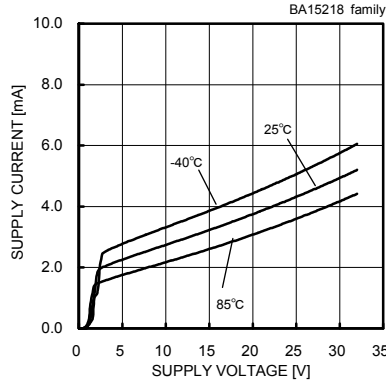

Fig. 112  
Supply Current - Supply Voltage

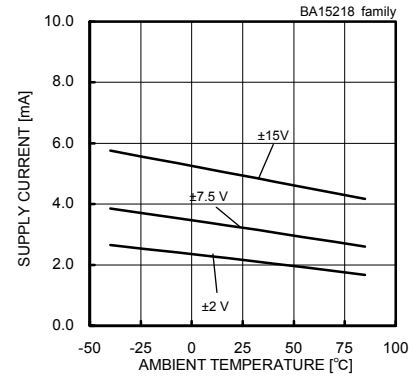

Fig. 113  
Supply Current - Ambient Temperature

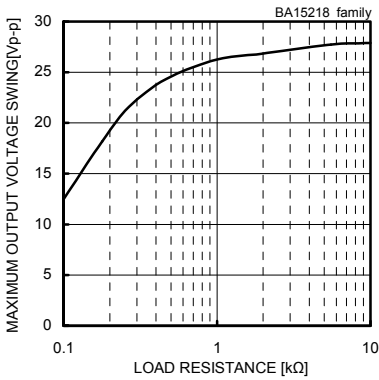

Fig. 114  
Maximum Output Voltage Swing  
- Load Resistance  
(VCC/VEE=+15[V]/-15[V], Ta=25[°C])

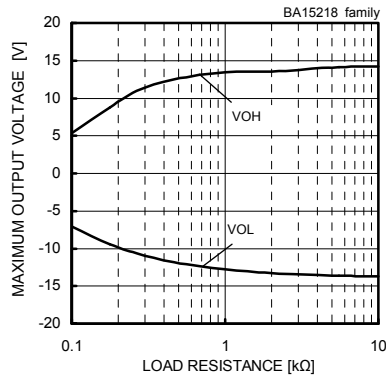

Fig. 115  
Maximum Output Voltage  
- Load Resistance  
(VCC/VEE=+15[V]/-15[V], Ta=25[°C])

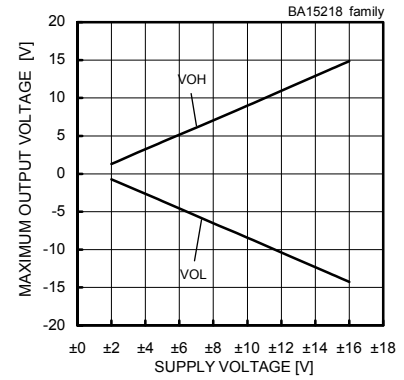

Fig. 116  
Maximum Output Voltage  
- Supply Voltage  
(RL=2[kΩ], Ta=25[°C])

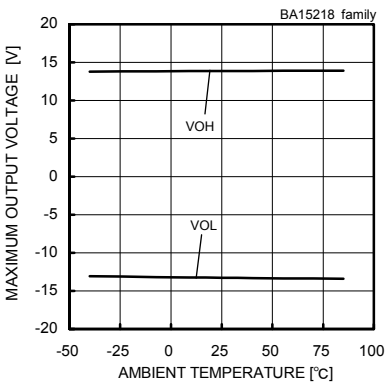

Fig. 117  
Maximum Output Voltage  
- Ambient Temperature  
(VCC/VEE=+15[V]/-15[V], RL=2[kΩ])

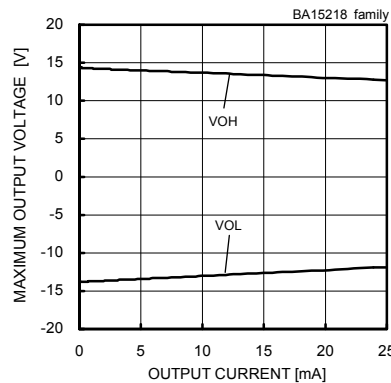

Fig. 118  
Maximum Output Voltage  
- Output Current  
(VCC/VEE=+15[V]/-15[V], Ta=25[°C])

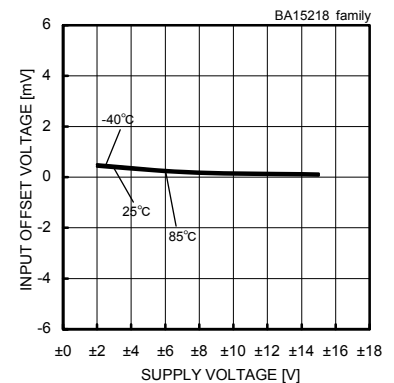

Fig. 119  
Input Offset Voltage - Supply Voltage  
(Vicm=0[V], Vout=0[V])

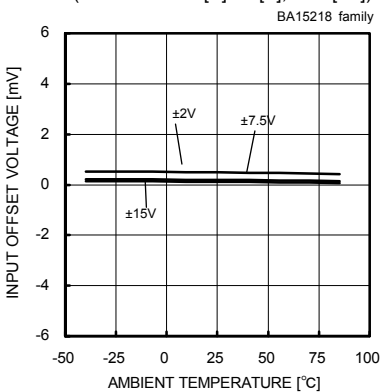

Fig. 120  
Input Offset Voltage - Ambient Temperature  
(Vicm=0[V], Vout=0[V])

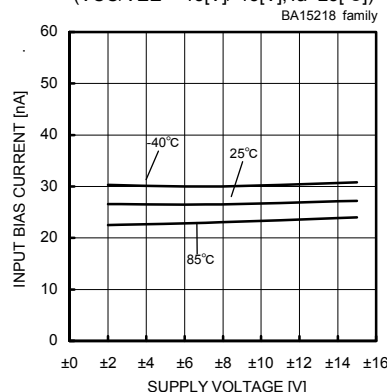

Fig. 121  
Input Bias Current - Supply Voltage  
(Vicm=0[V], Vout=0[V])

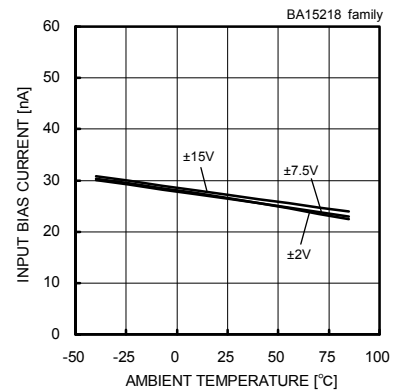

Fig. 122  
Input Bias Current - Ambient Temperature  
(Vicm=0[V], Vout=0[V])

(\*) The above data is ability value of sample, it is not guaranteed.

○BA15218 family

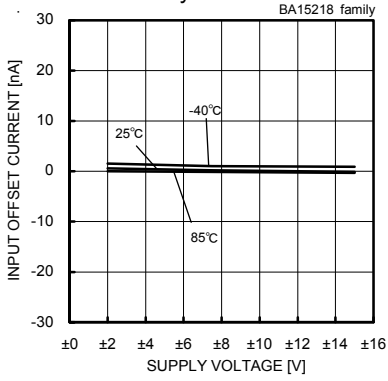

Fig. 123  
Input Offset Current – Supply Voltage  
( $V_{icm}=0[V]$ ,  $V_{out}=0[V]$ )

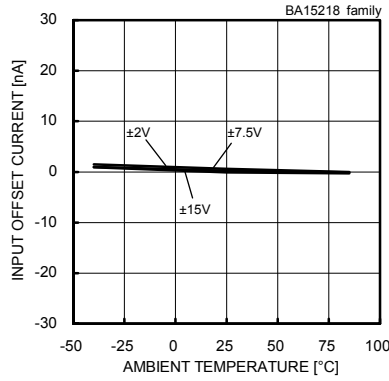

Fig. 124  
Input Offset Current – Ambient Temperature  
( $V_{icm}=0[V]$ ,  $V_{out}=0[V]$ )

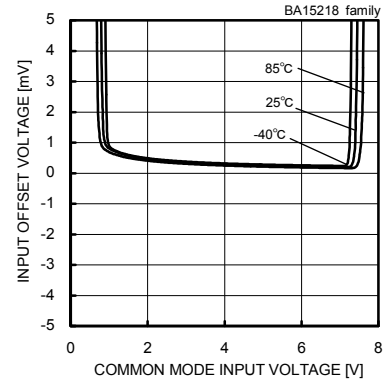

Fig. 125  
Input Offset Voltage  
– Common Mode Input Voltage  
( $V_{CC}=8[V]$ ,  $V_{out}=4[V]$ )

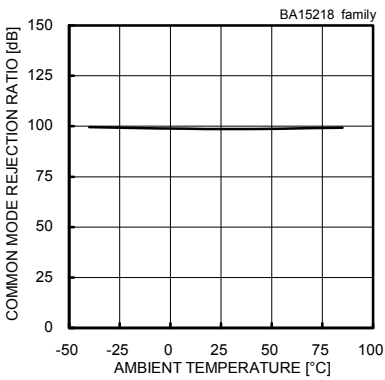

Fig. 126  
Common Mode Rejection Ratio  
– Ambient Temperature  
( $V_{CC}/V_{EE}=+15[V]/-15[V]$ ,  $V_{icm}=-12[V]$  to  $+12[V]$ )

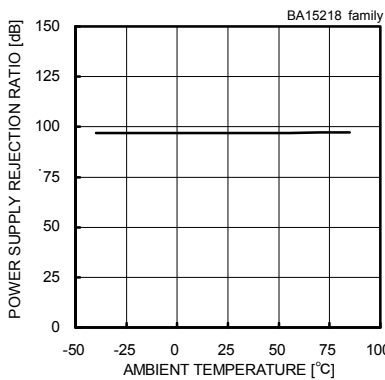

Fig. 127  
Power Supply Rejection Ratio  
– Ambient Temperature  
( $V_{CC}/V_{EE}=+2[V]/-2[V]$  to  $+15[V]/-15[V]$ )

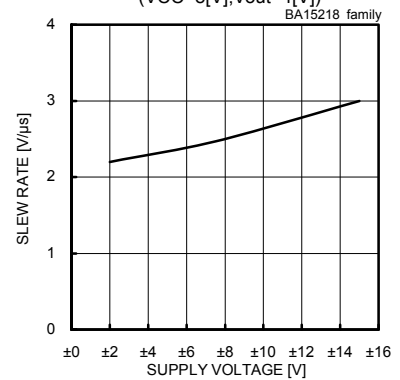

Fig. 128  
Slew Rate – Supply Voltage  
( $C_L=100[pF]$ ,  $R_L=2[k\Omega]$ ,  $T_a=25[^\circ C]$ )

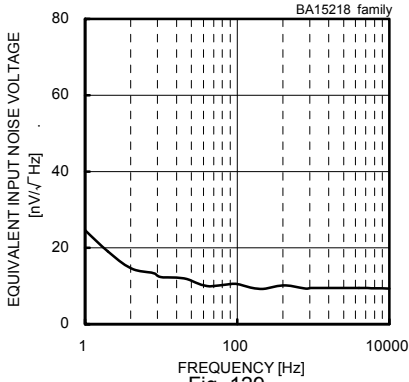

Fig. 129  
Equivalent Input Noise Voltage – Frequency  
( $V_{CC}/V_{EE}=+15[V]/-15[V]$ ,  $R_s=100[\Omega]$ ,  $T_a=25[^\circ C]$ )

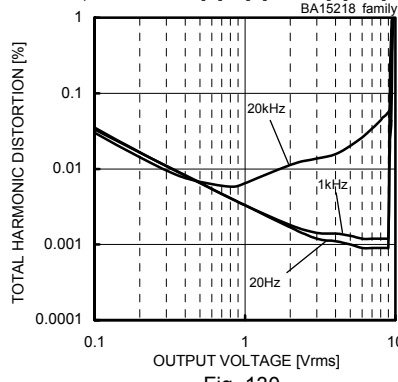

Fig. 130  
Total Harmonic Distortion – Output Voltage  
( $V_{CC}/V_{EE}=+15[V]/-15[V]$ ,  $A_v=20[dB]$ ,  
 $R_L=2[k\Omega]$ ,  $80[kHz]$ -LPF,  $T_a=25[^\circ C]$ )

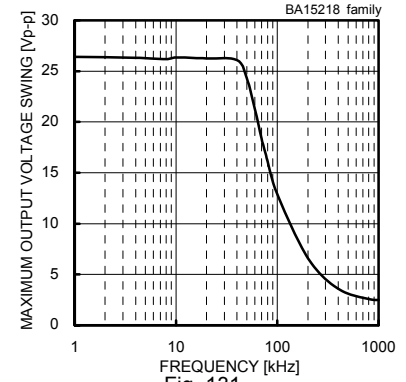

Fig. 131  
Maximum Output Voltage Swing – Frequency  
( $V_{CC}/V_{EE}=+15[V]/-15[V]$ ,  $R_L=2[k\Omega]$ ,  $T_a=25[^\circ C]$ )

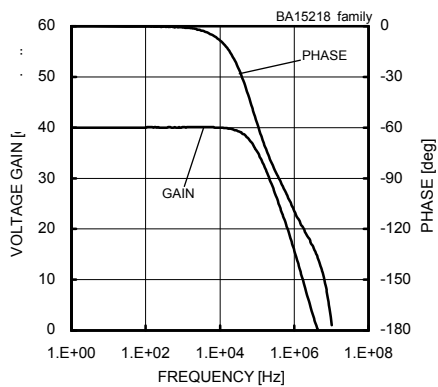

Fig. 132  
Voltage Gain – Frequency  
( $V_{CC}/V_{EE}=+15[V]/-15[V]$ ,  $A_v=40[dB]$ ,  $R_L=2[k\Omega]$ ,  $T_a=25[^\circ C]$ )

(\*) The above data is ability value of sample, it is not guaranteed.

OBA14741 family

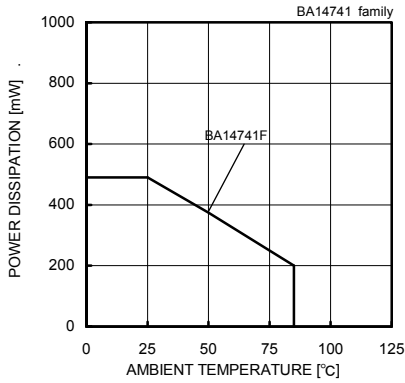

Fig. 133

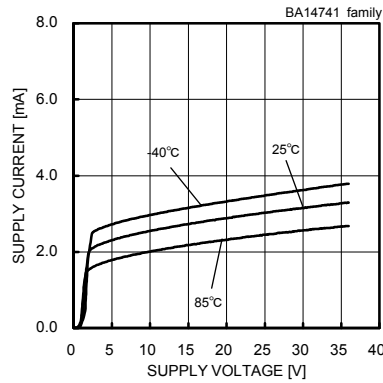

Fig. 134

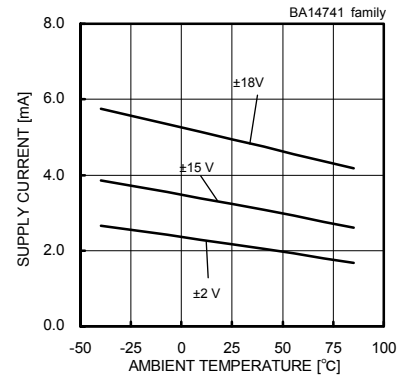

Fig. 135

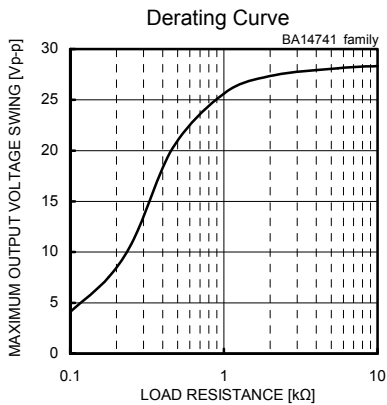

Fig. 136  
Derating Curve  
Maximum Output Voltage Swing  
– Load Resistance  
(VCC/VEE=+15[V]/-15[V], Ta=25[°C])

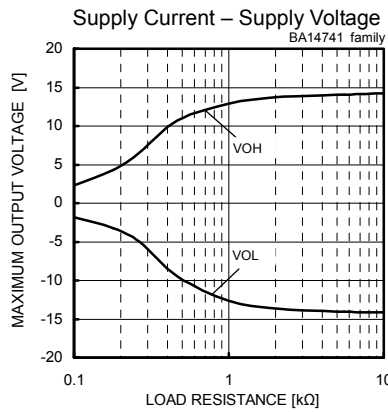

Fig. 137  
Supply Current – Supply Voltage  
Maximum Output Voltage  
– Load Resistance  
(VCC/VEE=+15[V]/-15[V], Ta=25[°C])

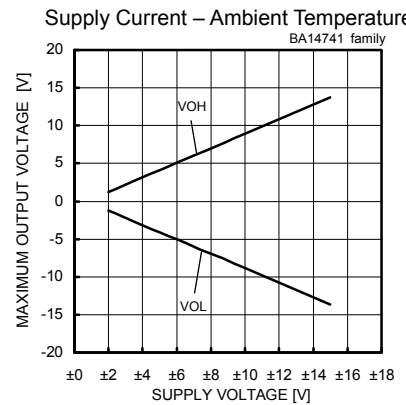

Fig. 138  
Supply Current – Ambient Temperature  
Maximum Output Voltage  
– Supply Voltage  
(RL=2[kΩ], Ta=25[°C])

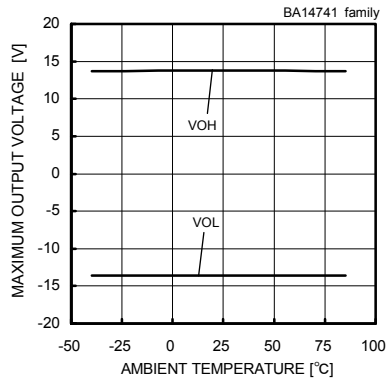

Fig. 139  
Maximum Output Voltage  
– Ambient Temperature  
(VCC/VEE=+15[V]/-15[V], RL=2[kΩ])

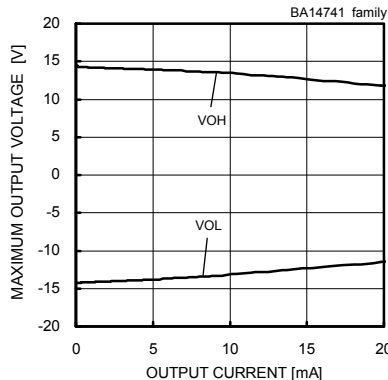

Fig. 140  
Maximum Output Voltage  
– Output Current  
(VCC/VEE=+15[V]/-15[V], Ta=25[°C])

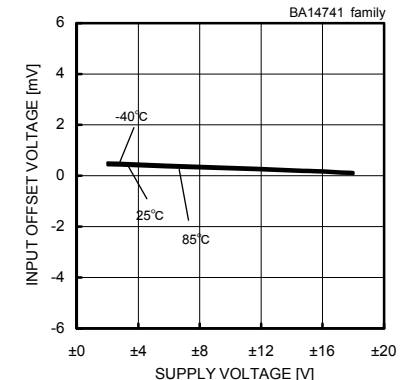

Fig. 141  
Input Offset Voltage – Supply Voltage  
(Vicm=0[V], Vout=0[V])

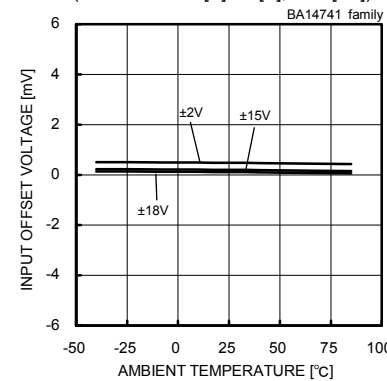

Fig. 142  
Input Offset Voltage – Ambient Temperature  
(Vicm=0[V], Vout=0[V])

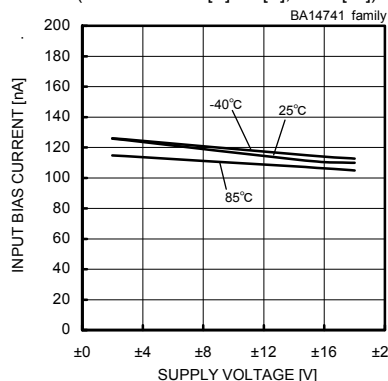

Fig. 143  
Input Bias Current – Supply Voltage  
(Vicm=0[V], Vout=0[V])

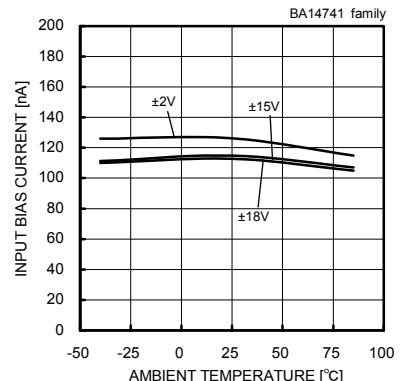

Fig. 144  
Input Bias Current – Ambient Temperature  
(Vicm=0[V], Vout=0[V])

(\*) The above data is ability value of sample, it is not guaranteed.

○BA14741 family

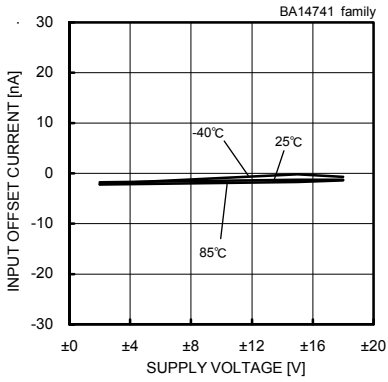

Fig. 145

Input Offset Current – Supply Voltage  
( $V_{icm}=0[V]$ ,  $V_{out}=0[V]$ )

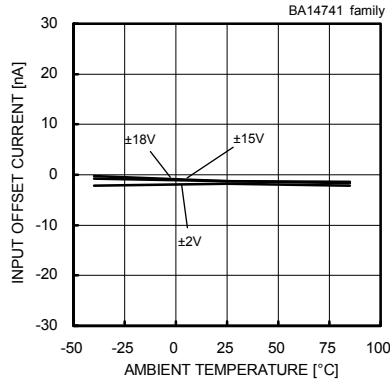

Fig. 146

Input Offset Current – Ambient Temperature  
( $V_{icm}=0[V]$ ,  $V_{out}=0[V]$ )

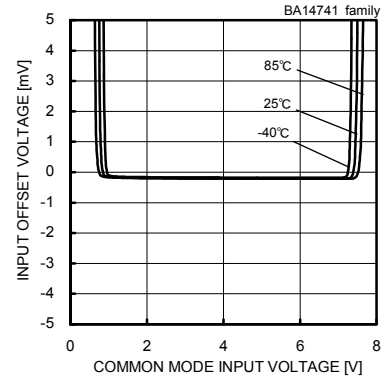

Fig. 147

Input Offset Voltage – Common Mode Input Voltage  
( $V_{CC}=8[V]$ ,  $V_{out}=4[V]$ )

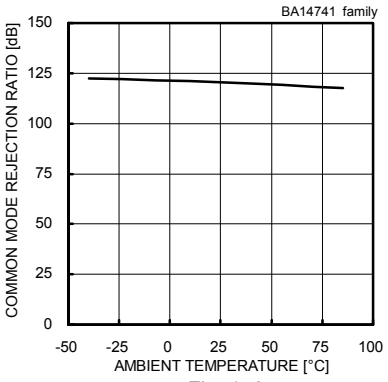

Fig. 148

Common Mode Rejection Ratio – Ambient Temperature  
( $V_{CC}/V_{EE}=+15[V]/-15[V]$ ,  $V_{icm}=-12[V]$  to  $+12[V]$ )

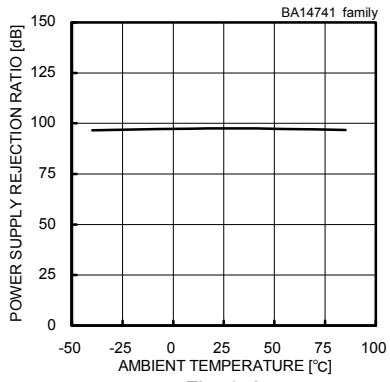

Fig. 149

Power Supply Rejection Ratio – Ambient Temperature  
( $V_{CC}/V_{EE}=+2[V]/-2[V]$  to  $+15[V]/-15[V]$ )

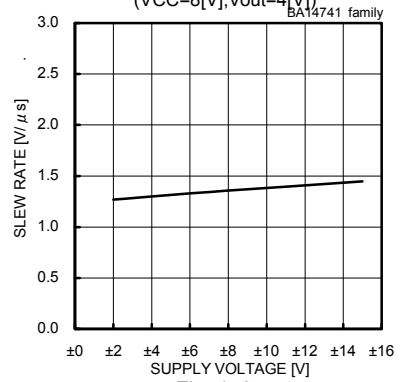

Fig. 150

Slew Rate – Supply Voltage  
( $C_L=100[pF]$ ,  $R_L=2[k\Omega]$ ,  $T_a=25[^\circ C]$ )

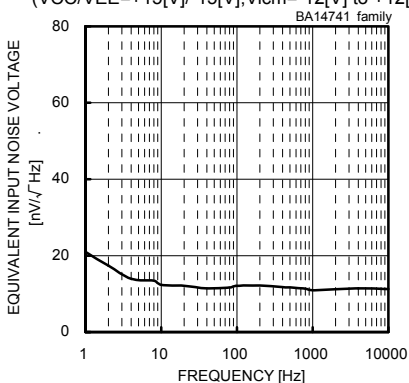

Fig. 151

Equivalent Input Noise Voltage – Frequency  
( $V_{CC}/V_{EE}=+15[V]/-15[V]$ ,  $R_s=100[\Omega]$ ,  $T_a=25[^\circ C]$ )

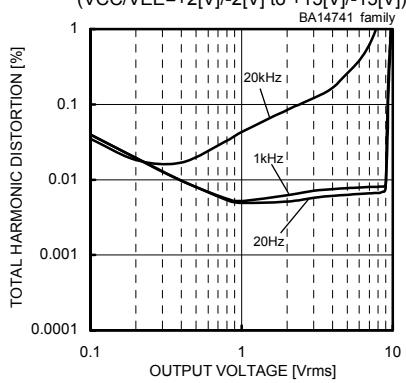

Fig. 152

Total Harmonic Distortion – Output Voltage  
( $V_{CC}/V_{EE}=+15[V]/-15[V]$ ,  $A_v=20[dB]$ ,  $R_L=2[k\Omega]$ ,  $80[kHz]$ -LPF,  $T_a=25[^\circ C]$ )

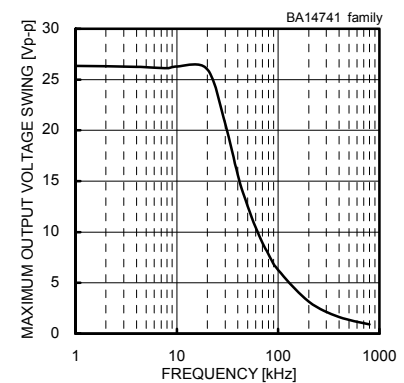

Fig. 153

Maximum Output Voltage Swing – Frequency  
( $V_{CC}/V_{EE}=+15[V]/-15[V]$ ,  $R_L=2[k\Omega]$ ,  $T_a=25[^\circ C]$ )

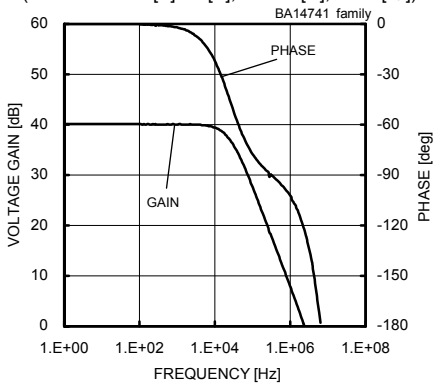

Fig. 154

Voltage Gain – Frequency

( $V_{CC}/V_{EE}=+15[V]/-15[V]$ ,  $A_v=40[dB]$ ,  $R_L=2[k\Omega]$ ,  $T_a=25[^\circ C]$ )

(\*) The above data is ability value of sample, it is not guaranteed.

OBA15532 family

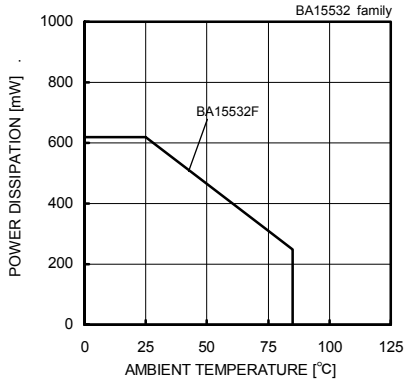

Fig. 155  
Derating Curve

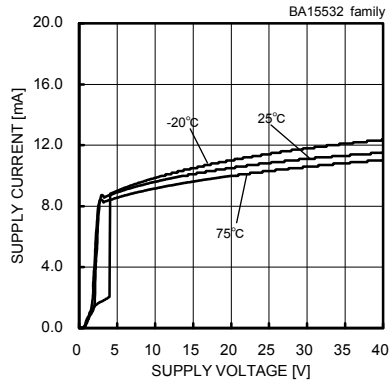

Fig. 156  
Supply Current - Supply Voltage

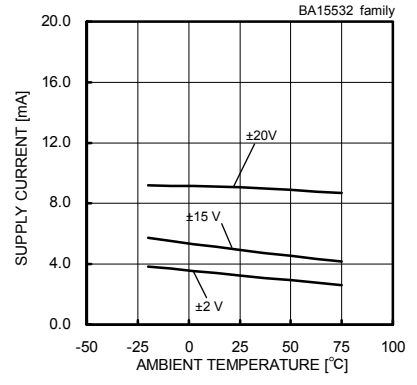

Fig. 157  
Supply Current - Ambient Temperature

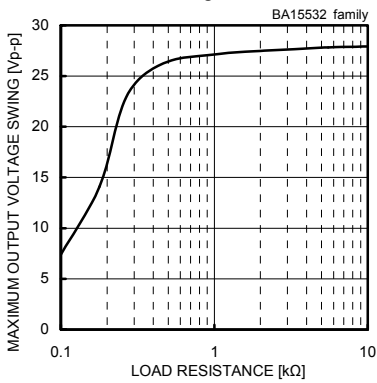

Fig. 158  
Maximum Output Voltage Swing - Load Resistance  
(VCC/VEE=+15[V]/-15[V], Ta=25[°C])

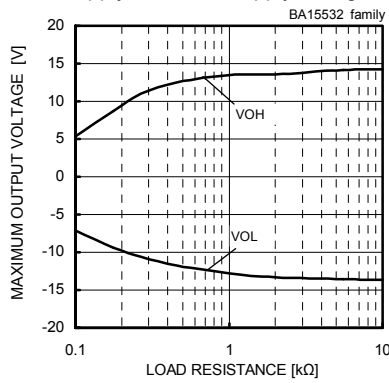

Fig. 159  
Maximum Output Voltage - Load Resistance  
(VCC/VEE=+15[V]/-15[V], Ta=25[°C])

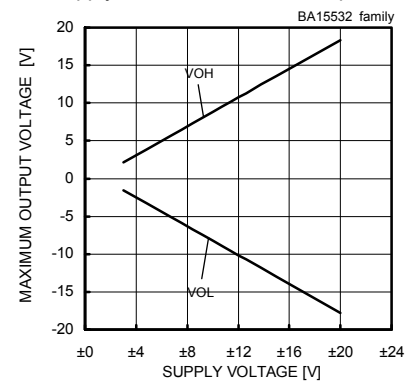

Fig. 160  
Maximum Output Voltage - Supply Voltage  
(RL=2[kΩ], Ta=25[°C])

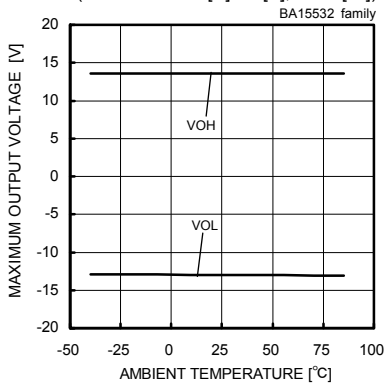

Fig. 161  
Maximum Output Voltage - Ambient Temperature  
(VCC/VEE=+15[V]/-15[V], RL=2[kΩ])

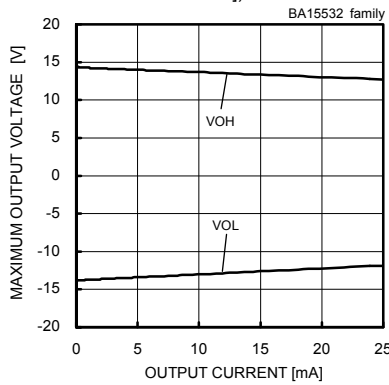

Fig. 162  
Maximum Output Voltage - Output Current  
(VCC/VEE=+15[V]/-15[V], Ta=25[°C])

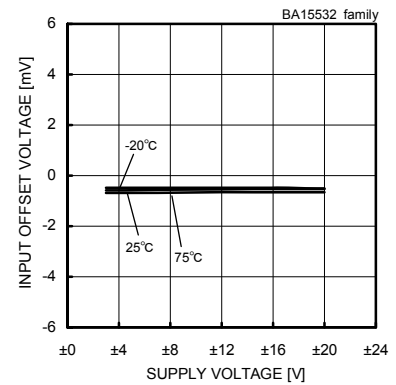

Fig. 163  
Input Offset Voltage - Supply Voltage  
(Vicm=0[V], Vout=0[V])

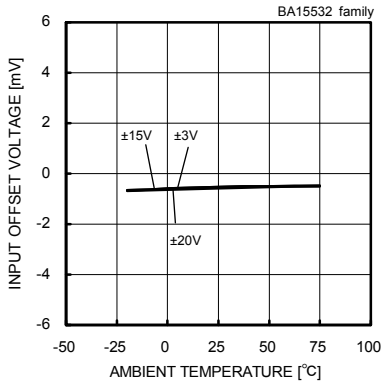

Fig. 164  
Input Offset Voltage - Ambient Temperature  
(Vicm=0[V], Vout=0[V])

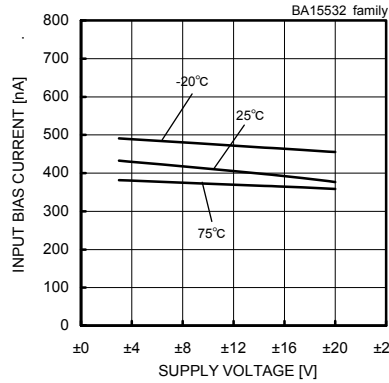

Fig. 165  
Input Bias Current - Supply Voltage  
(Vicm=0[V], Vout=0[V])

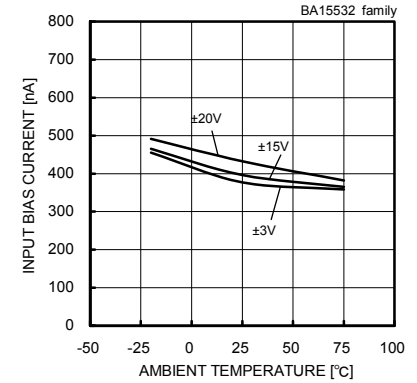

Fig. 166  
Input Bias Current - Ambient Temperature  
(Vicm=0[V], Vout=0[V])

(\*) The above data is ability value of sample, it is not guaranteed.

BA15532 family

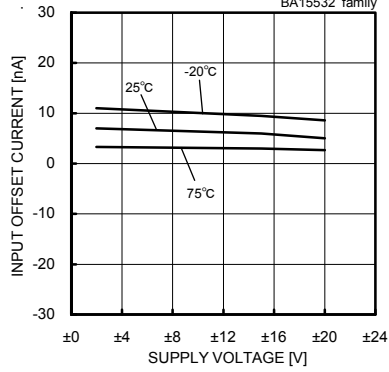

Fig. 167

Input Offset Current – Supply Voltage  
( $V_{icm}=0[V]$ ,  $V_{out}=0[V]$ )

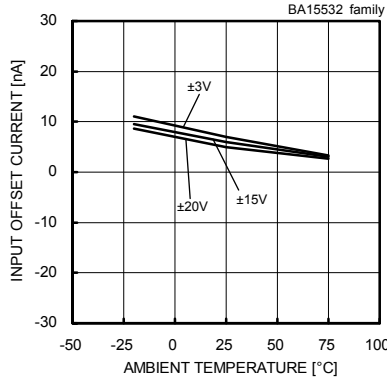

Fig. 168

Input Offset Current – Ambient Temperature  
( $V_{icm}=0[V]$ ,  $V_{out}=0[V]$ )

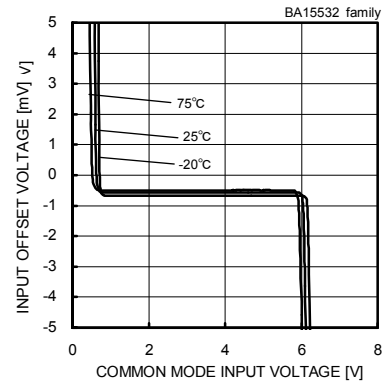

Fig. 169

Input Offset Voltage – Common Mode  
Input Voltage ( $V_{CC}=8[V]$ ,  $V_{out}=4[V]$ )

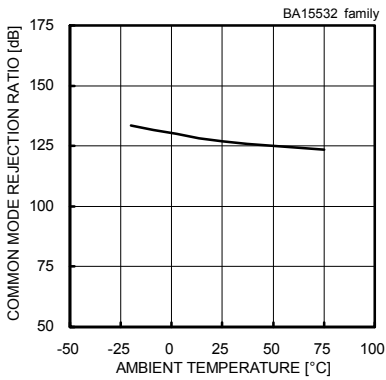

Fig. 170

Common Mode Rejection Ratio  
– Ambient Temperature  
( $V_{CC}/V_{EE}=+15[V]/-15[V]$ ,  $V_{icm}=-12[V]$  to  $+12[V]$ )

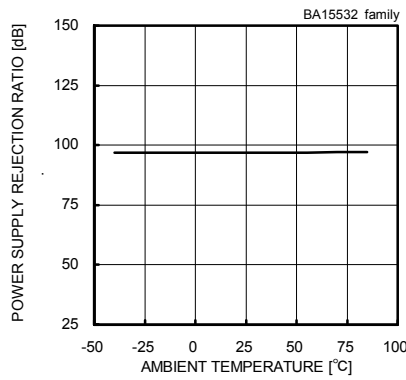

Fig. 171

Power Supply Rejection Ratio  
– Ambient Temperature  
( $V_{CC}/V_{EE}=+3[V]/-3[V]$  to  $+15[V]/-15[V]$ )

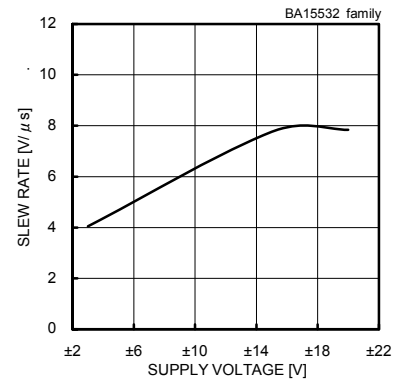

Fig. 172

Slew Rate – Supply Voltage  
( $C_L=100[pF]$ ,  $R_L=2[k\Omega]$ ,  $T_a=25[^\circ C]$ )

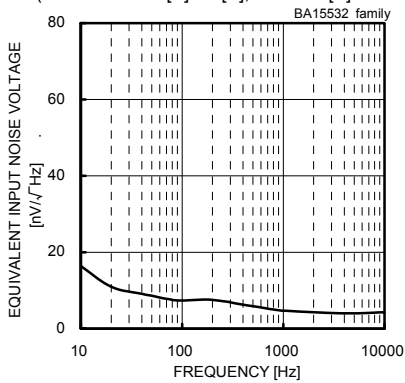

Fig. 173

Equivalent Input Noise Voltage – Frequency  
( $V_{CC}/V_{EE}=+15[V]/-15[V]$ ,  $R_s=100[\Omega]$ ,  $T_a=25[^\circ C]$ )

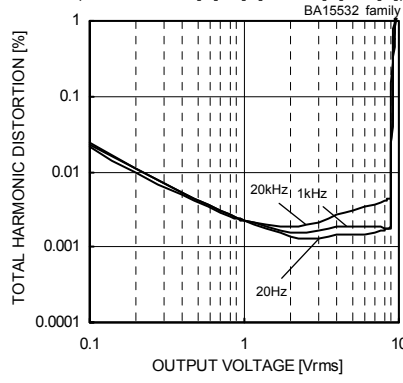

Fig. 174

Total Harmonic Distortion – Output Voltage  
( $V_{CC}/V_{EE}=+15[V]/-15[V]$ ,  $A_v=20[dB]$ ,  
 $R_L=600[\Omega]$ ,  $80[kHz]$ -LPPF,  $T_a=25[^\circ C]$ )

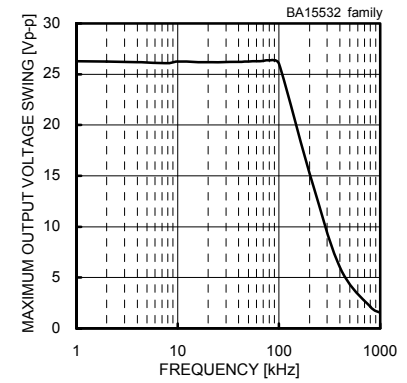

Fig. 175

Maximum Output Voltage Swing – Frequency  
( $V_{CC}/V_{EE}=+15[V]/-15[V]$ ,  $R_L=600[\Omega]$ ,  $T_a=25[^\circ C]$ )

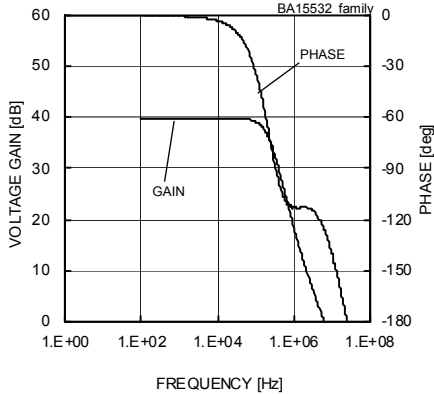

Fig. 176

Voltage Gain – Frequency ( $V_{CC}/V_{EE}=+15[V]/-15[V]$ ,  $A_v=40[dB]$ ,  $R_L=2[k\Omega]$ ,  $T_a=25[^\circ C]$ )

(\*) The above data is ability value of sample, it is not guaranteed.

OBA4510 family

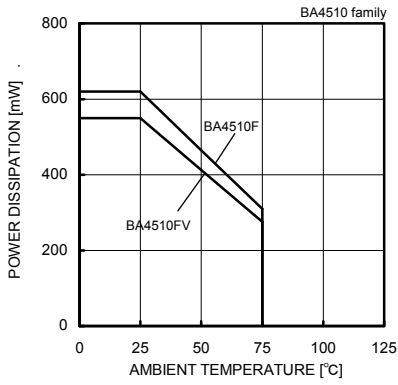

Fig. 177

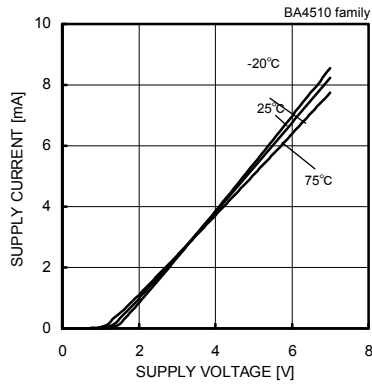

Fig. 178

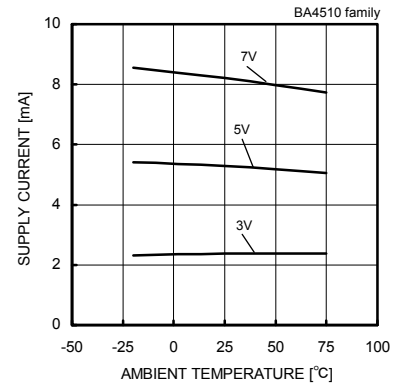

Fig. 179

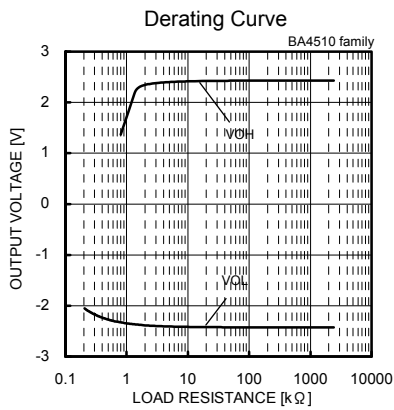

Fig. 180

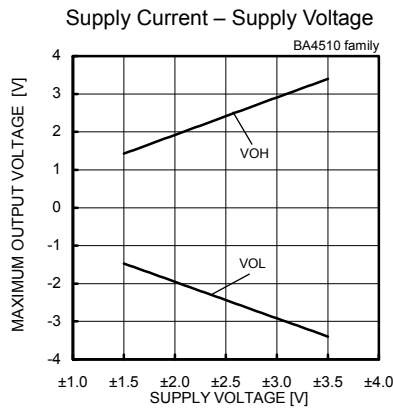

Fig. 181

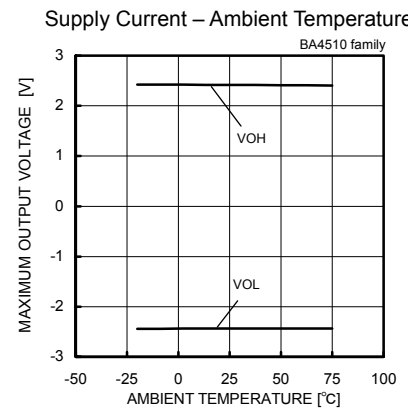

Fig. 182

Output Voltage - Load Resistance  
(VCC/VEE=2.5[V]/-2.5[V], Ta=25°C)

Maximum Output Voltage - Supply Voltage  
(RL=10[kΩ], Ta=25°C)

Maximum Output Voltage - Ambient Temperature  
(VCC/VEE=2.5[V]/-2.5[V], RL=10[kΩ])

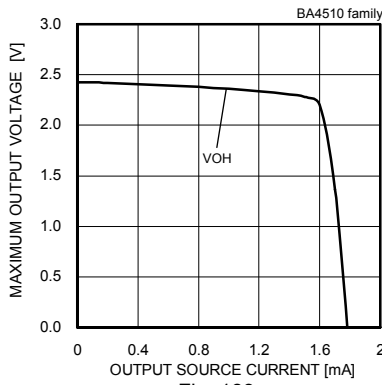

Fig. 183

Maximum Output Voltage- Output Source Current  
(VCC/VEE=2.5[V]/-2.5[V], Ta=25°C)

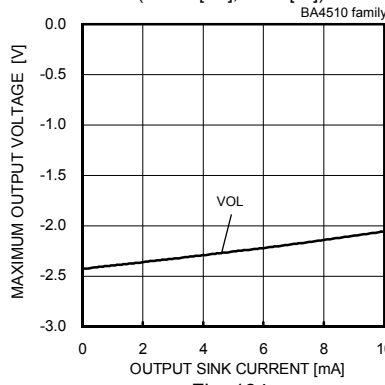

Fig. 184

Maximum Output Voltage- Output Sink Current  
(VCC/VEE=2.5[V]/-2.5[V], Ta=25°C)

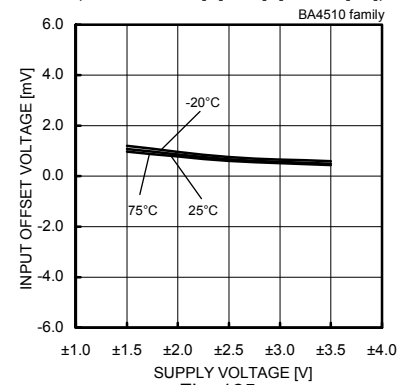

Fig. 185

Input Offset Voltage - Supply Voltage  
(Vicm=0[V], Vout=0[V])

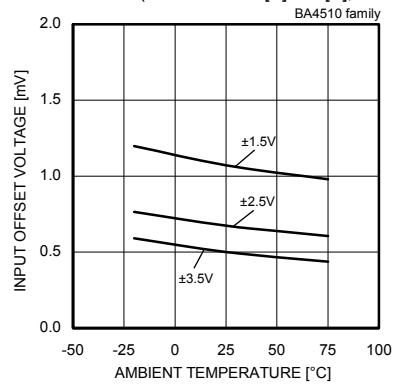

Fig. 186

Input Offset Voltage - Ambient Temperature  
(Vicm=0[V], Vout=0[V])

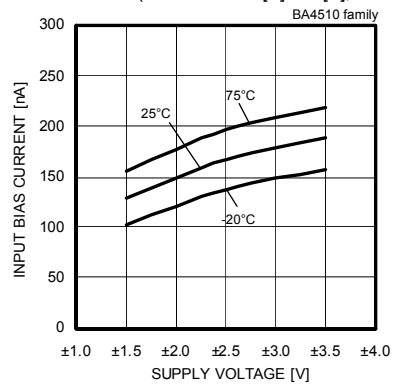

Fig. 187

Input Bias Current - Supply Voltage  
(Vicm=0[V], Vout=0[V])

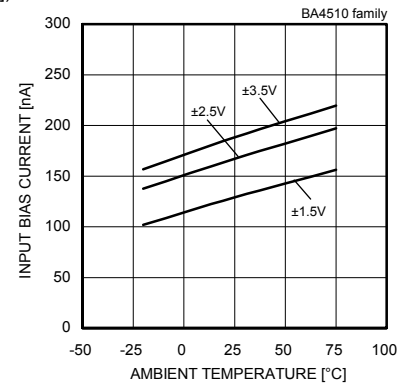

Fig. 188

Input Bias Current - Ambient Temperature  
(Vicm=0[V], Vout=0[V])

(\*) The above data is ability value of sample, it is not guaranteed.

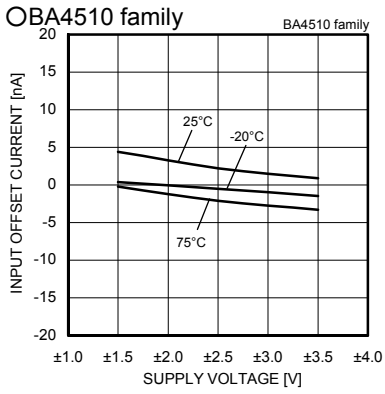

Fig. 189

Input Offset Current – Supply Voltage  
( $V_{icm}=0[V]$ ,  $V_{out}=0[V]$ )

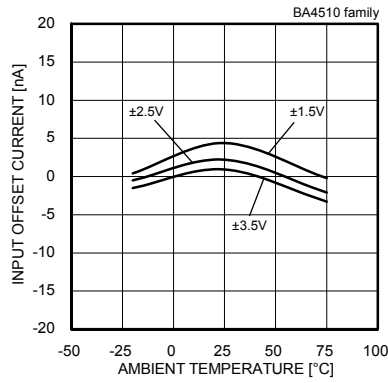

Fig. 190

Input Offset Current – Ambient Temperature  
( $V_{icm}=0[V]$ ,  $V_{out}=0[V]$ )

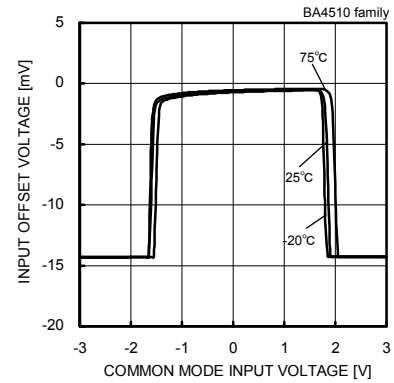

Fig. 191

Input Offset Voltage – Common Mode  
Input Voltage ( $V_{CC}/V_{EE}=2.5[V]/-2.5[V]$ )

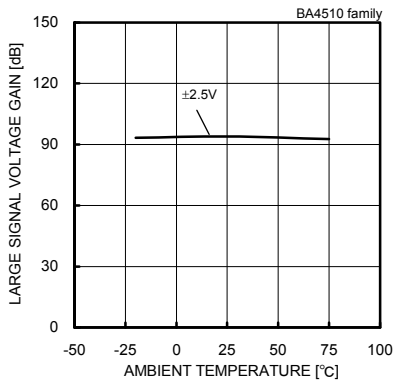

Fig. 192

Large Signal Voltage Gain  
– Ambient Temperature

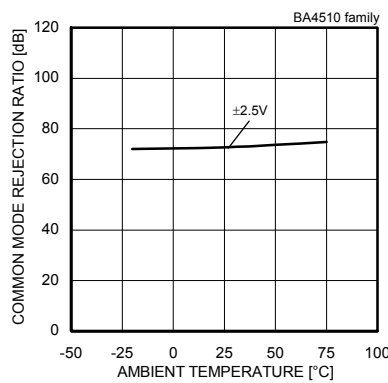

Fig. 193

Common Mode Rejection Ratio  
– Ambient Temperature

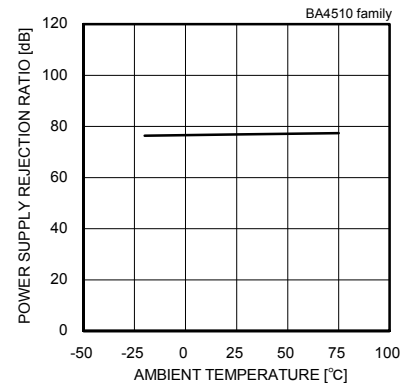

Fig. 194

Power Supply Rejection Ratio  
– Ambient Temperature

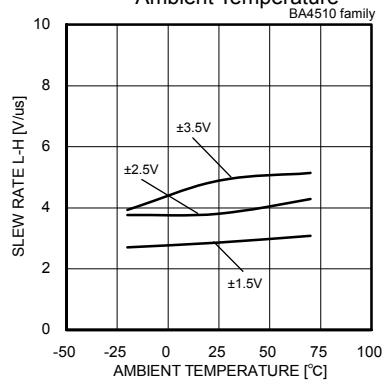

Fig. 195

Slew Rate L-H – Ambient Temperature

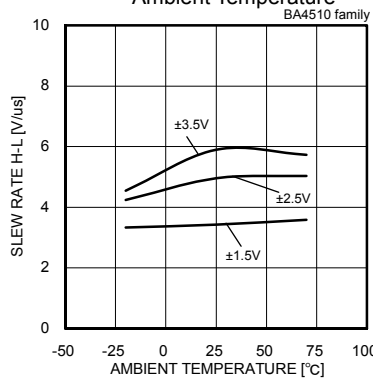

Fig. 196

Slew Rate H-L – Ambient Temperature

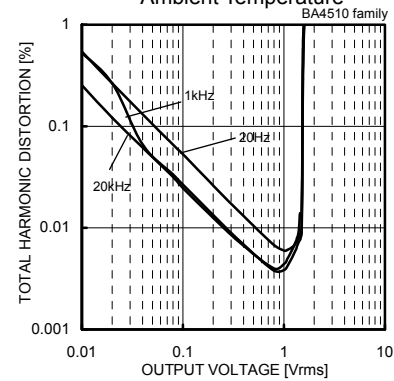

Fig. 197

Total Harmonic Distortion – Output Voltage  
( $V_{CC}/V_{EE}=2.5[V]/-2.5[V]$ ,  $R_L=3[k\Omega]$ ,  
80[kHz]-LPF,  $T_a=25[^\circ C]$ )

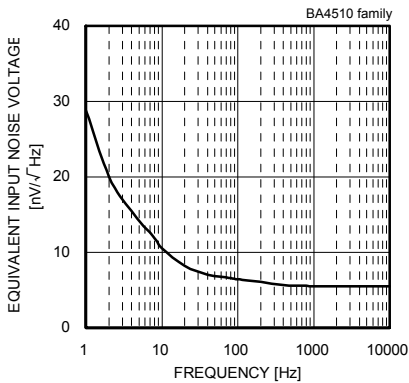

Fig. 198

Equivalent Input Noise Voltage – Frequency  
( $V_{CC}/V_{EE}=2.5[V]/-2.5[V]$ )

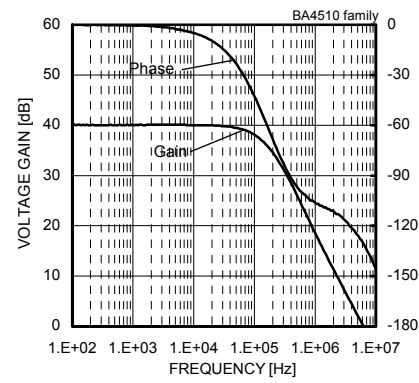

Fig. 199

Voltage Gain – Frequency  
( $V_{CC}/V_{EE}=2.5[V]/-2.5[V]$ ,  $A_v=40[dB]$ ,  $R_L=10[k\Omega]$ )

(\*) The above data is ability value of sample, it is not guaranteed.



OBA2115 family

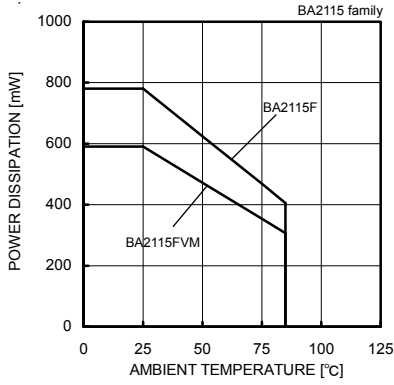

Fig. 200

Derating Curve

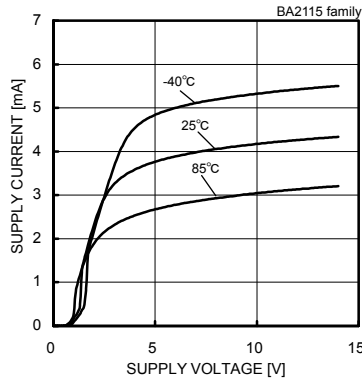

Fig. 201

Supply Current - Supply Voltage

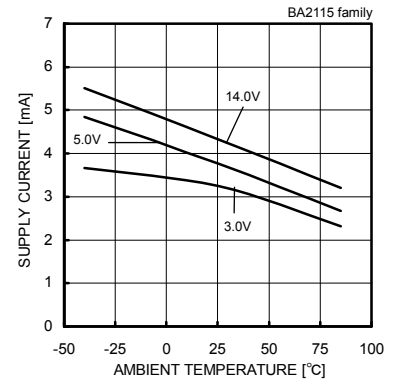

Fig. 202

Supply Current - Ambient Temperature

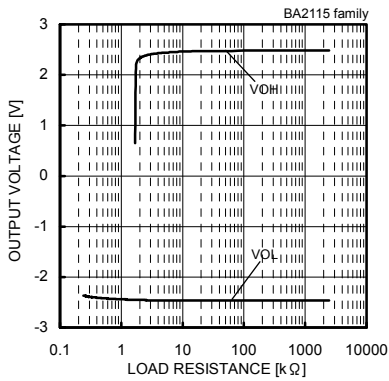

Fig. 203

Output Voltage - Load Resistance  
(VCC/VEE=+2.5[V]/-2.5[V])

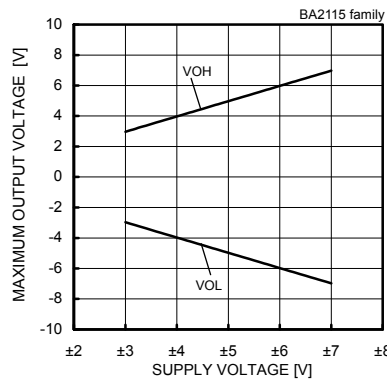

Fig. 204

Maximum Output Voltage - Supply Voltage  
(RL=10[kΩ])

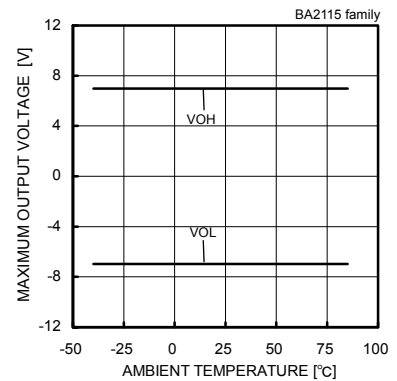

Fig. 205

Maximum Output Voltage - Ambient Temperature  
(VCC/VEE=+7.5[V]/-7.5[V], RL=10[kΩ])

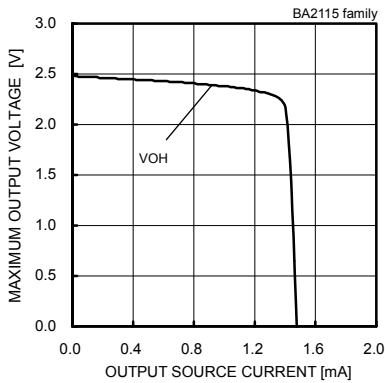

Fig. 206

Maximum Output Voltage - Output Source Current  
(VCC/VEE=+2.5[V]/-2.5[V])

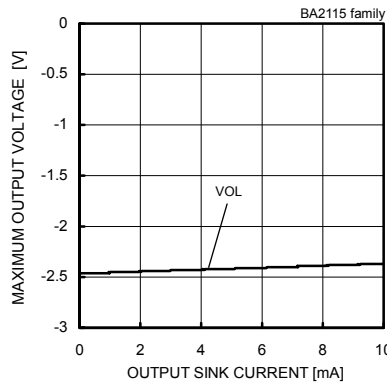

Fig. 207

Maximum Output Voltage - Output Sink Current  
(VCC/VEE=+2.5[V]/-2.5[V])

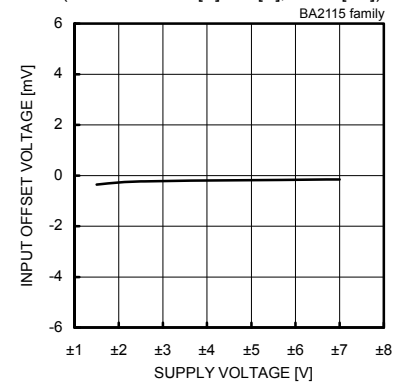

Fig. 208

Input Offset Voltage - Supply Voltage  
(Vcm=0[V], Vout=0[V])

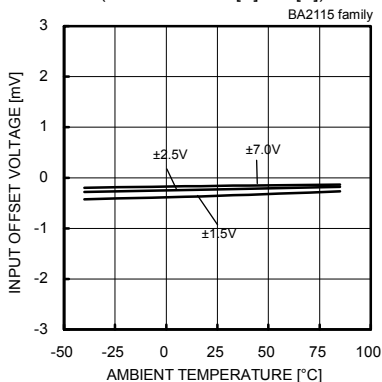

Fig. 209

Input Offset Voltage - Ambient Temperature  
(Vcm=0[V], Vout=0[V])

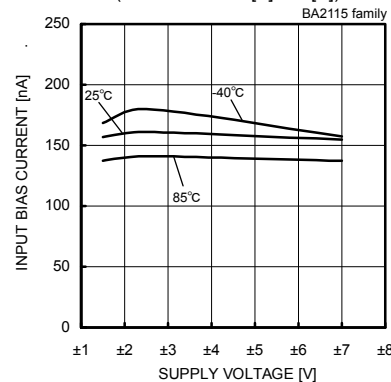

Fig. 210

Input Bias Current - Supply Voltage  
(Vcm=0[V], Vout=0[V])

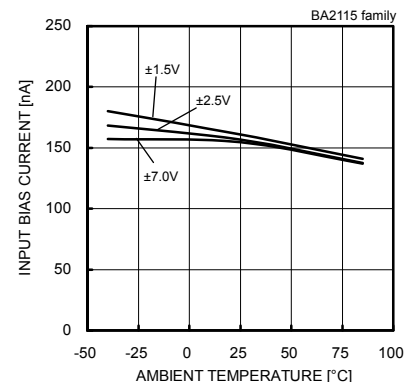

Fig. 211

Input Bias Current - Ambient Temperature  
(Vcm=0[V], Vout=0[V])

(\*) The above data is ability value of sample, it is not guaranteed.

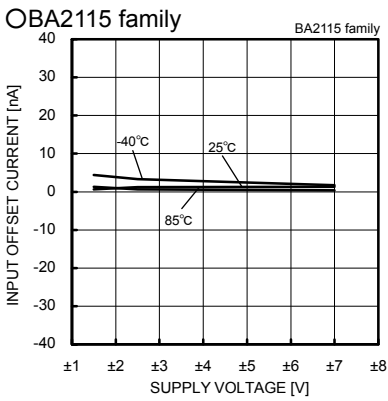

Fig. 212  
Input Offset Current – Supply Voltage  
( $V_{icm}=0[V]$ ,  $V_{out}=0[V]$ )

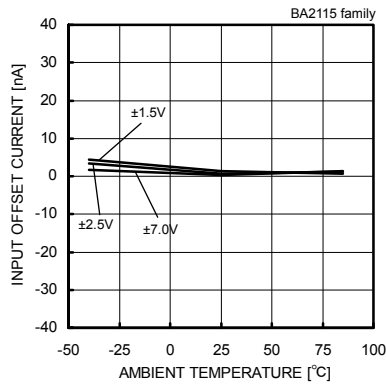

Fig. 213  
Input Offset Current – Ambient Temperature  
( $V_{icm}=0[V]$ ,  $V_{out}=0[V]$ )

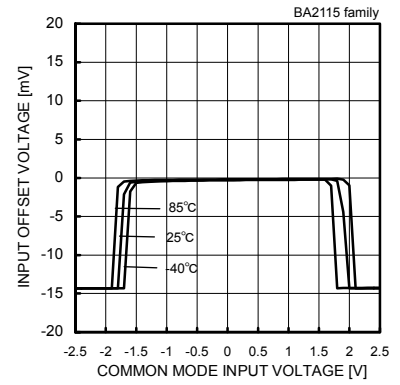

Fig. 214  
Input Offset Voltage  
– Common Mode Input Voltage  
( $V_{CC}/V_{EE}=+2.5[V]/-2.5[V]$ ,  $V_{out}=0[V]$ )

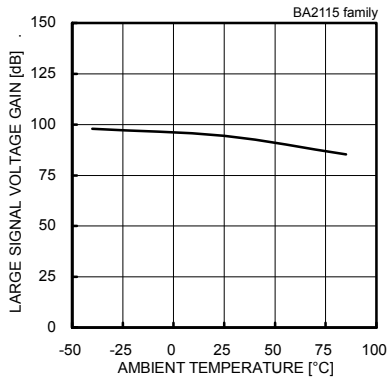

Fig. 215  
Large Signal Voltage Gain  
– Ambient Temperature  
( $V_{CC}/V_{EE}=+2.5[V]/-2.5[V]$ )

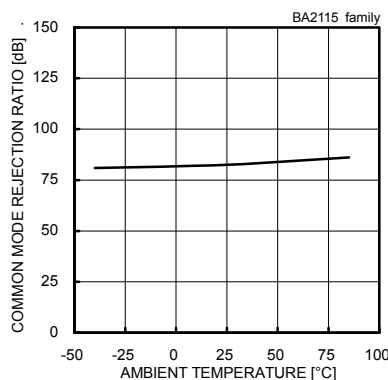

Fig. 216  
Common Mode Rejection Ratio  
– Ambient Temperature  
( $V_{CC}/V_{EE}=+2.5[V]/-2.5[V]$ )

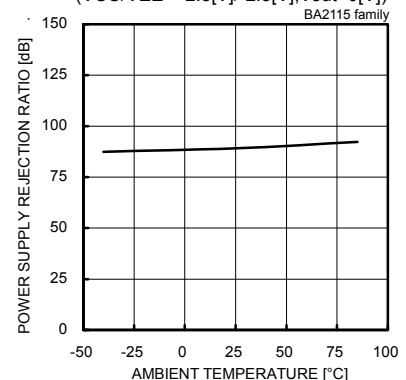

Fig. 217  
Power Supply Rejection Ratio  
– Ambient Temperature  
( $V_{CC}/V_{EE}=+2.5[V]/-2.5[V]$ )

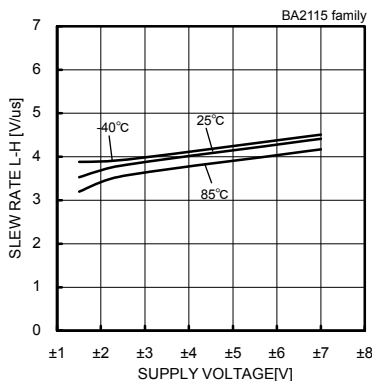

Fig. 218  
Slew Rate L-H – Supply Voltage

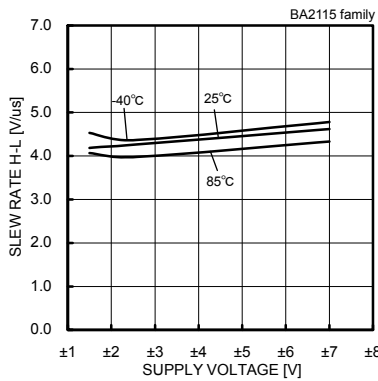

Fig. 219  
Slew Rate H-L – Supply Voltage

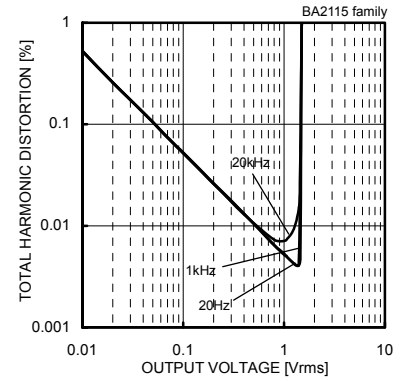

Fig. 220  
Total Harmonic Distortion – Output Voltage  
( $V_{CC}/V_{EE}=2.5[V]/-2.5[V]$ ,  $R_L=3[k\Omega]$   
80[kHz]-LPF,  $T_a=25[^\circ C]$ )

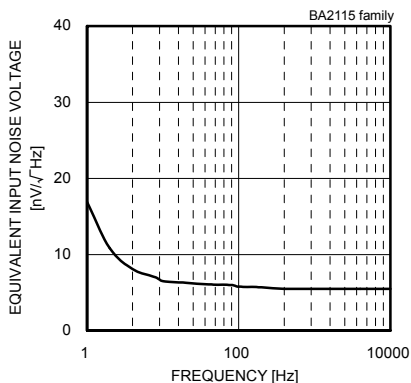

Fig. 221  
Equivalent Input Noise Voltage – Frequency  
( $V_{CC}/V_{EE}=2.5[V]/-2.5[V]$ )

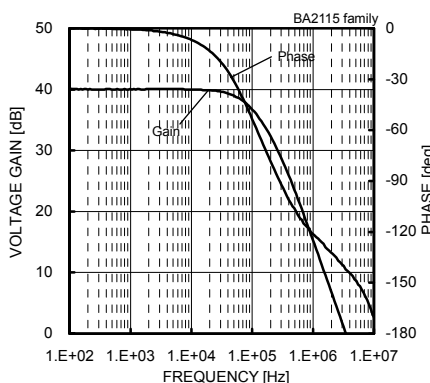

Fig. 222  
Voltage Gain – Frequency  
( $V_{CC}/V_{EE}=2.5[V]/-2.5[V]$ ,  $A_v=40[dB]$ ,  $R_L=10[k\Omega]$ )

Fig. 223

(\*) The above data is ability value of sample, it is not guaranteed.

● Schematic diagram

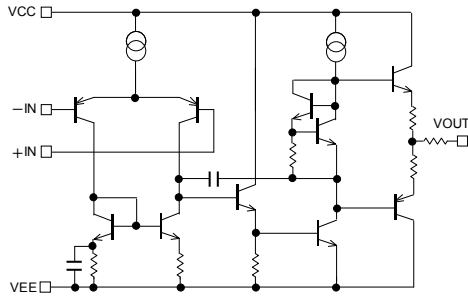

Fig. 224 Simplified schematic (BA4558/BA4558R/BA15218/BA4560/BA4560R/BA4580R)

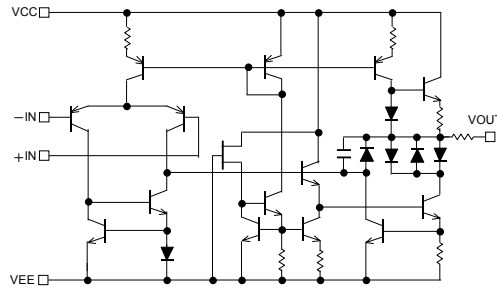

Fig. 225 Simplified schematic (BA14741)

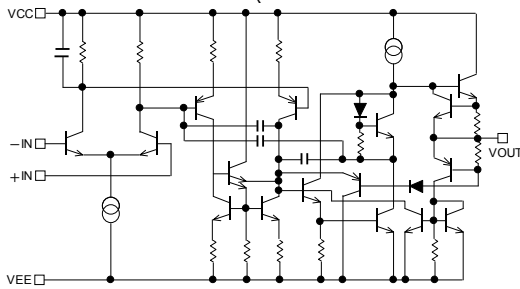

Fig. 226 Simplified schematic (BA15532)

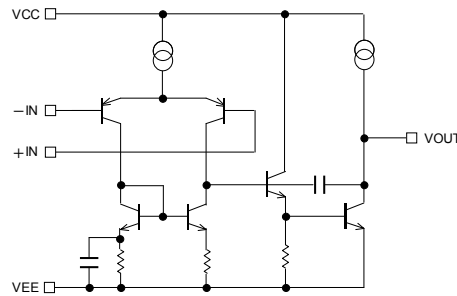

Fig. 227 Simplified schematic (BA4510/BA2115)

● Test circuit1 NULL method

VCC,VEE,EK, Vicm Unit : [V], Vicm=0[V] For all parameter

Parameter	VF	S1	S2	S3 <sup>(*23)</sup>	BA4558/BA4558R BA4560/BA4560R			BA4580R BA15218/BA14741			BA15532			BA4510			BA2115			Calculation
					Vcc	VEE	EK	Vcc	VEE	EK	Vcc	VEE	EK	Vcc	VEE	EK	Vcc	VEE	EK	
Input Offset Voltage	VF1	ON	ON	OFF	15	-15	0	15	-15	0	15	-15	0	2.5	2.5	0	2.5	2.5	0	1
Input Offset Current	VF2	OFF	OFF	OFF	15	-15	0	15	-15	0	15	-15	0	2.5	2.5	0	2.5	2.5	0	2
Input Bias Current	VF3	OFF	ON	OFF	15	-15	0	15	-15	0	15	-15	0	2.5	2.5	0	2.5	2.5	0	3
	VF4	ON	OFF		15	-15	0	15	-15	0	15	-15	0	2.5	2.5	0	2.5	2.5	0	
Large Signal Voltage Gain	VF5	ON	ON	ON	15	-15	-10	15	-15	-10	15	-15	-10	2.5	2.5	-1.0	2.5	2.5	-1.0	4
	VF6				15	-15	10	15	-15	10	15	-15	10	2.5	2.5	1.0	2.5	2.5	1.0	
Common-mode Rejection Ratio (Input Common-mode Voltage Range)	VF7	ON	ON	OFF	3	-27	12	3	-27	12	3	-27	12	1.5	1.5	-1.0	1.5	1.5	-1.0	5
	VF8				27	-3	-12	27	-3	-12	27	-3	-12	3.5	3.5	1.0	3.5	3.5	1.0	
Power Supply Rejection Ratio	VF9	ON	ON	OFF	4	-4	0	2	-2	0	3	-3	0	1.25	-1.25	0	0.75	-1.25	0	6
	VF10				15	-15	0	16	-16	0	20	-20	0	3.0	-3.0	0	7.0	7.0	0	

(\*23) S3 is always ON for BA15532.

-Calculation-

1. Input Offset Voltage (Vio)

$$V_{io} = \frac{|VF1|}{1 + R_f / R_s} [V]$$

2. Input Offset Current (Iio)

$$I_{io} = \frac{|VF2 - VF1|}{R_i \times (1 + R_f / R_s)} [A]$$

3. Input Bias Current (Ib)

$$I_b = \frac{|VF4 - VF3|}{2 \times R_i \times (1 + R_f / R_s)} [A]$$

4. Large Signal Voltage Gain (Av)  $Av = 20 \times \text{Log} \frac{\Delta E_k \times (1 + R_f / R_s)}{|VF5 - VF6|} [dB]$

5. Common-mode Rejection Ratio (CMRR)  $CMRR = 20 \times \text{Log} \frac{\Delta V_{icm} \times (1 + R_f / R_s)}{|VF8 - VF7|} [dB]$

6. Power Supply Rejection Ratio (PSRR)  $PSRR = 20 \times \text{Log} \frac{\Delta V_{cc} \times (1 + R_f / R_s)}{|VF10 - VF9|} [dB]$

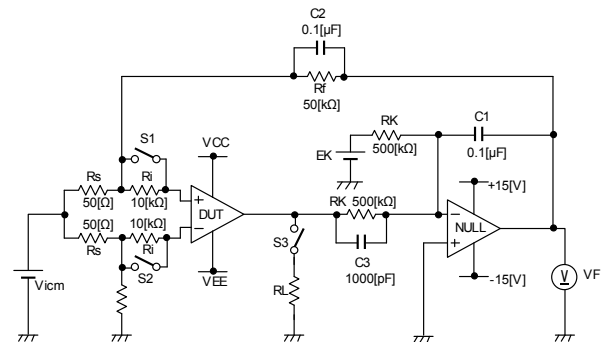

Fig. 228 Test circuit 1 (one channel only)

● Test circuit2 switch condition

SW No.	SW 1	SW 2	SW 3	SW 4	SW 5	SW 6	SW 7	SW 8	SW 9	SW 10	SW 11	SW 12	SW 13	SW 14
Supply Current	OFF	OFF	OFF	ON	OFF	ON	OFF	OFF	OFF	OFF	OFF	OFF	OFF	OFF
Maximum Output Voltage	Load Resistance	OFF	OFF	ON	OFF	OFF	OFF	ON	OFF	ON	OFF	OFF	OFF	ON
	Output Current	OFF	OFF	ON	OFF	OFF	OFF	ON	OFF	OFF	OFF	OFF	ON	ON
Slew Rate	OFF	OFF	OFF	ON	OFF	OFF	OFF	ON	ON	ON	OFF	OFF	OFF	OFF
Gain Bandwidth Product	OFF	ON	OFF	OFF	ON	ON	OFF	OFF	ON	ON	ON	OFF	OFF	OFF
Total Harmonic Distortion	ON	OFF	OFF	OFF	ON	OFF	ON	OFF	ON	ON	ON	OFF	OFF	OFF
Input Noise Voltage (*24)	ON	OFF	OFF	OFF	ON	ON	OFF	OFF	OFF	OFF	ON	OFF	OFF	OFF

(\*24) this condition refers only to BA4558Rfamily, BA4560Rfamily

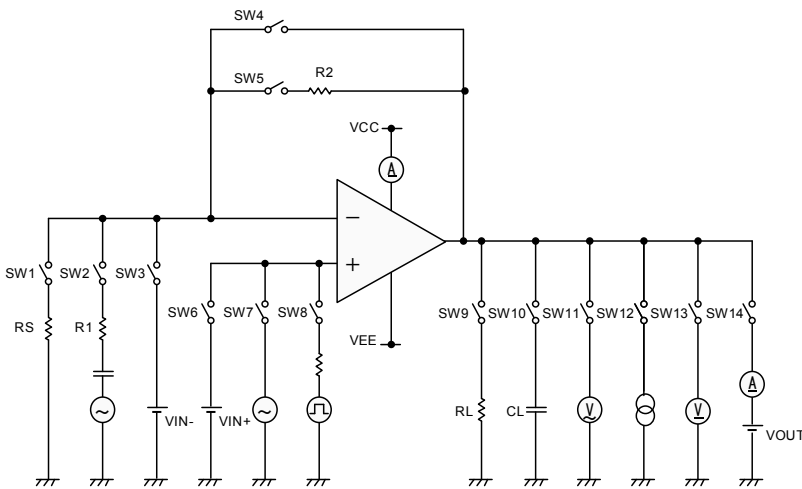

Fig. 229. Test circuit2 (one channel only)

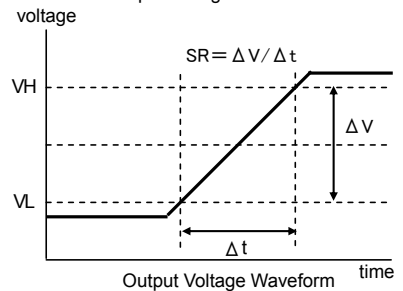
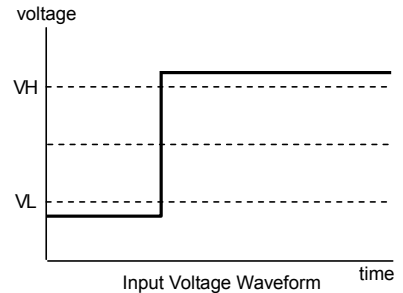

Fig. 230 Slew rate input output wave

● Test circuit3 Channel separation

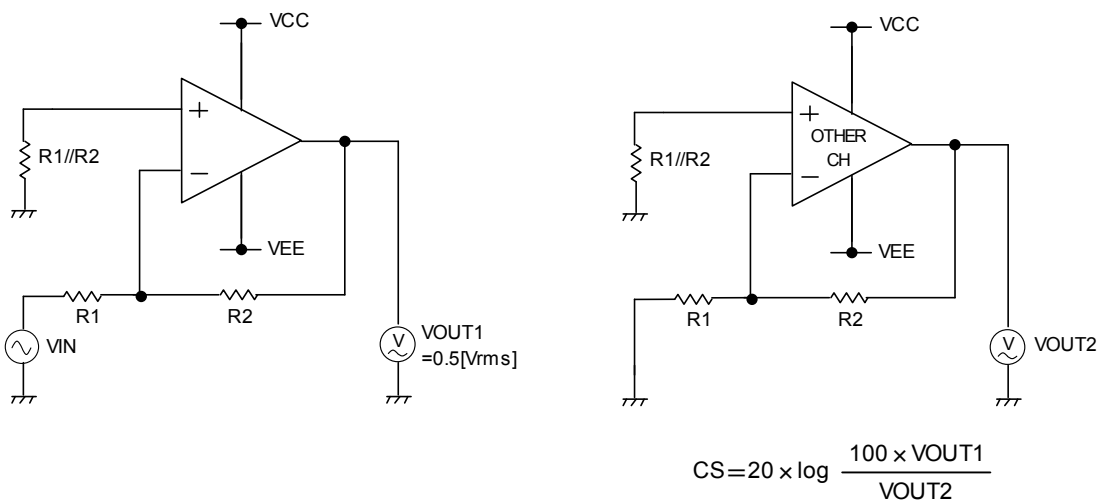

Fig. 231 Test circuit3  
(VCC=+15[V],VEE=-15[V],R1=1[kΩ],R2=100[kΩ])

**●Description of electrical characteristics**

Described here are the terms of electric characteristics used in this technical note. Items and symbols used are also shown. Note that item name and symbol and their meaning may differ from those on another manufacture's document or general document.

**1. Absolute maximum ratings**

Absolute maximum rating item indicates the condition which must not be exceeded. Application of voltage in excess of absolute maximum rating or use out of absolute maximum rated temperature environment may cause deterioration of characteristics.

- 1.1 Power supply voltage(VCC-VEE)  
Indicates the maximum voltage that can be applied between the positive power supply terminal and negative power supply terminal without deterioration or destruction of characteristics of internal circuit.
- 1.2 Differential input voltage(Vid)  
Indicates the maximum voltage that can be applied between non-inverting terminal and inverting terminal without deterioration and destruction of characteristics of IC.
- 1.3 Input common-mode voltage range(Vicm)  
Indicates the maximum voltage that can be applied to non-inverting terminal and inverting terminal without deterioration or destruction of characteristics. Input common-mode voltage range of the maximum ratings not assure normal operation of IC. When normal operation of IC is desired, the input common-mode voltage of characteristics item must be followed.
- 1.4 Power dissipation(Pd)  
Indicates the power that can be consumed by specified mounted board at the ambient temperature 25°C(normal temperature). As for package product, Pd is determined by the temperature that can be permitted by IC chip in the package(maximum junction temperature)and thermal resistance of the package.

**2. Electrical characteristics item**

- 2.1 Input offset voltage(Vio)  
Indicates the voltage difference between non-inverting terminal and inverting terminal. It can be translated into the input voltage difference required for setting the output voltage at 0 [V] .
- 2.3 Input offset current(Iio)  
Indicates the difference of input bias current between non-inverting terminal and inverting terminal.
- 2.5 Input bias current(Ib)  
Indicates the current that flows into or out of the input terminal. It is defined by the average of input bias current at non-inverting terminal and input bias current at inverting terminal.
- 2.6 Circuit current(ICC)  
Indicates the IC current that flows under specified conditions and no-load steady status.
- 2.7 High level output voltage / Low level output voltage(VOH/VOL)  
Indicates the voltage range that can be output by the IC under specified load condition. It is typically divided into high-level output voltage and low-level output voltage. High-level output voltage indicates the upper limit of output voltage. Low-level output voltage indicates the lower limit.
- 2.8 Large signal voltage gain(AV)  
Indicates the amplifying rate (gain) of output voltage against the voltage difference between non-inverting terminal and inverting terminal. It is normally the amplifying rate (gain) with reference to DC voltage.  
$$A_v = (\text{Output voltage fluctuation}) / (\text{Input offset fluctuation})$$
- 2.9 Input common-mode voltage range(Vicm)  
Indicates the input voltage range where IC operates normally.
- 2.10 Common-mode rejection ratio(CMRR)  
Indicates the ratio of fluctuation of input offset voltage when in-phase input voltage is changed. It is normally the fluctuation of DC.  
$$\text{CMRR} = (\text{Change of Input common-mode voltage}) / (\text{Input offset fluctuation})$$
- 2.11 Power supply rejection ratio(PSRR)  
Indicates the ratio of fluctuation of input offset voltage when supply voltage is changed. It is normally the fluctuation of DC.  
$$\text{PSRR} = (\text{Change of power supply voltage}) / (\text{Input offset fluctuation})$$
- 2.13 Channel separation(CS)  
Indicates the fluctuation of input offset voltage or that of output voltage with reference to the change of output voltage of driven channel.
- 2.14 Slew rate(SR)  
Indicates the time fluctuation ratio of voltage output when step input signal is applied.
- 2.12 Unity gain frequency(ft)  
Indicates a frequency where the voltage gain of Op-Amp is 1.
- 2.13 Total harmonic distortion + Noise(THD+N)  
Indicates the fluctuation of input offset voltage or that of output voltage with reference to the change of output voltage of driven channel.
- 2.14 Input referred noise voltage(Vn)  
Indicates a noise voltage generated inside the operational amplifier equivalent by ideal voltage source connected in series with input terminal.

● Derating curve

Power dissipation (total loss) indicates the power that can be consumed by IC at Ta=25°C(normal temperature). IC is heated when it consumed power, and the temperature of IC chip becomes higher than ambient temperature. The temperature that can be accepted by IC chip depends on circuit configuration, manufacturing process, and consumable power is limited. Power dissipation is determined by the temperature allowed in IC chip (maximum junction temperature) and thermal resistance of package (heat dissipation capability). The maximum junction temperature is typically equal to the maximum value in the storage temperature range. Heat generated by consumed power of IC radiates from the mold resin or lead frame of the package. The parameter which indicates this heat dissipation capability (hardness of heat release) is called thermal resistance, represented by the symbol  $\theta_{j-a}$  [°C/W]. The temperature of IC inside the package can be estimated by this thermal resistance. Fig.232 (a) shows the model of thermal resistance of the package. Thermal resistance  $\theta_{ja}$ , ambient temperature Ta, junction temperature Tj, and power dissipation Pd can be calculated by the equation below :

$$\theta_{ja} = (T_j - T_a) / P_d \quad [^{\circ}\text{C}/\text{W}] \quad \dots \dots \quad (I)$$

Derating curve in Fig.232 (b) indicates power that can be consumed by IC with reference to ambient temperature. Power that can be consumed by IC with reference to attenuate at certain ambient temperature. This gradient, is determined by thermal resistance  $\theta_{ja}$ . Thermal resistance  $\theta_{ja}$  depends on chip size, power consumption, package, ambient temperature, package condition, wind velocity, etc even when the same of package is used. Thermal reduction curve indicates a reference value measured at a specified condition. Fig.233(a), (b), (c), (d) show a derating curve for an example of BA4558, BA4560, BA4558R, BA4560R, BA4580R, BA15218, BA14741, BA15532, BA4510, BA2115.

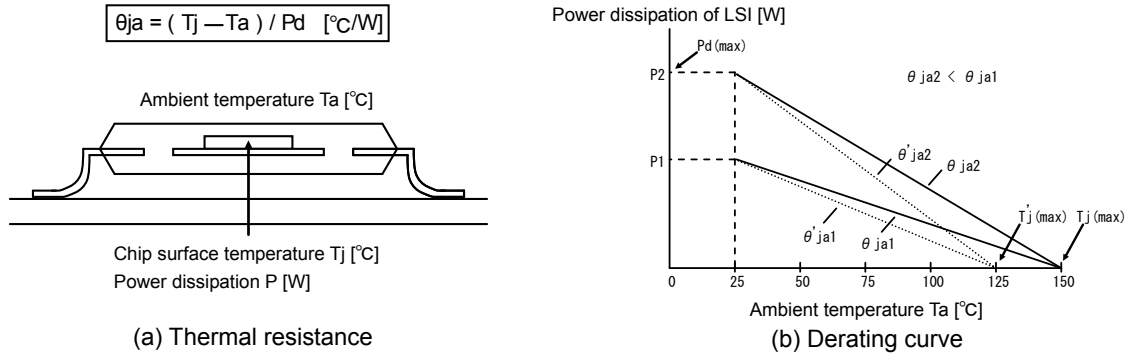
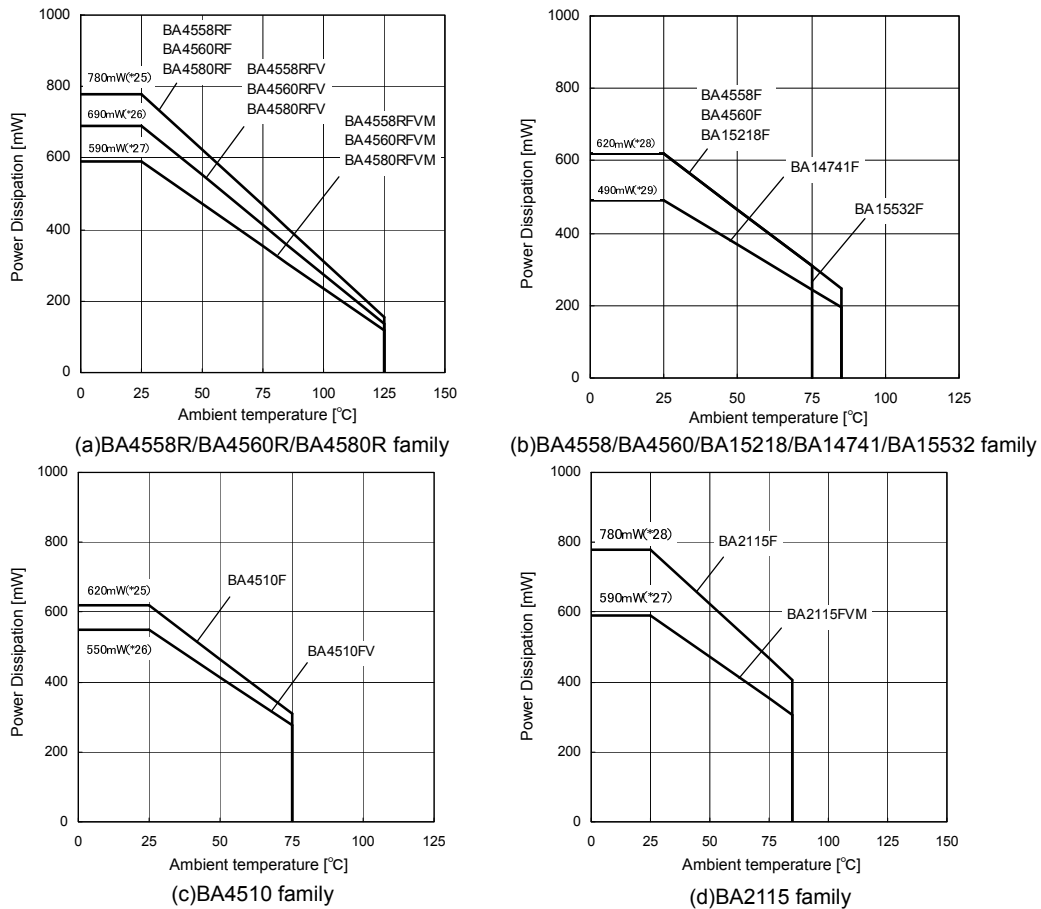

Fig. 232 Thermal resistance and derating curve



(*25)	(*26)	(*27)	(*28)	(*29)	Unit
6.2	5.5	4.7	6.2	4.9	[mW/°C]

When using the unit above Ta=25[°C], subtract the value above per degree[°C]. Permissible dissipation is the value when FR4 glass epoxy board 70[mm]×70[mm]×1.6[mm] (cooper foil area below 3[%]) is mounted.

Fig. 233 Derating curve

●Cautions on use

1) Processing of unused circuit

It is recommended to apply connection (see the Fig.234) and set the noninverting input terminal at the potential within input common-mode voltage range (Vicm), for any unused circuit.

2) Input voltage

Applying VEE+36[V](BA4550R,BA4560R,BA4580R family), VEE+14[V] (BA2115 family) to the input terminal is possible without causing deterioration of the electrical characteristics or destruction, irrespective of the supply voltage. However, this does not ensure normal circuit operation.

Please note that the circuit operates normally only when the input voltage is within the common mode input voltage range of the electric characteristics.

3) Maximum output voltage

Because the output voltage range becomes narrow as the output current increases, design the application with margin by considering changes in electrical characteristics and temperature characteristics.

4) Short-circuit of output terminal

When output terminal and VCC or VEE terminal are shorted, excessive Output current may flow under some conditions, and heating may destroy IC. It is necessary to connect a resistor as shown in Fig.2, thereby Protecting against load shorting.

5) Power supply (split supply / single supply) in used

Op-amp operates when specified voltage is applied between VCC and VEE. Therefore, the single supply Op-Amp can be used for double supply Op-Amp as well.

6) Power dissipation (Pd)

Use a thermal design that allows for a sufficient margin in light of the power dissipation (Pd) in actual operating conditions.

7) Short-circuit between pins and wrong mounting

Pay attention to the assembly direction of the ICs. Wrong mounting direction or shorts between terminals, GND, or other components on the circuits, can damage the IC.

8) Use in strong electromagnetic field

Using the ICs in strong electromagnetic field can cause operation malfunction.

9) Radiation

This IC is not designed to be radiation-resistant.

10) Handling of IC

When stress is applied to IC because of deflection or bend of board, the characteristics may fluctuate due to piezoelectric (piezo) effect.

11) Inspection on set board

During testing, turn on or off the power before mounting or dismounting the board from the test Jig.

Do not power up the board without waiting for the output capacitors to discharge. The capacitors in the low output impedanceterminal can stress the device. Pay attention to the electro static voltages during IC handling, transportation, and storage.

12) Output capacitor

When VCC terminal is shorted to VEE (GND) potential and an electric charge has accumulated on the external capacitor, connected to output terminal, accumulated charge may be discharged VCC terminal via the parasitic element within the circuit or terminal protection element. The element in the circuit may be damaged (thermal destruction). When using this IC for an application circuit where there is oscillation, output capacitor load does not occur, as when using this IC as a voltage comparator. Set the capacitor connected to output terminal below 0.1[μF] in order to prevent damage to IC.

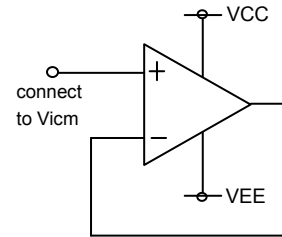

Fig. 234The example of application circuit for unused op-amp

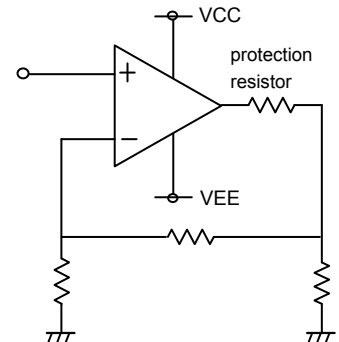

Fig. 235The example of output short protection

●Ordering part number

B	A
---	---

Part No.

4	5	6	0
---	---	---	---

Part No.

4558	4558R
4560	4560R
4510	4580R
14741	15218
15532	2115

F	V
---	---

Package

F: SOP8  
SOP14  
FV: SSOP-B8  
FVM: MSOP8

E	2
---	---

Packaging and forming specification

E2: Embossed tape and reel  
(SOP8/SOP14/SSOP-B8)  
TR: Embossed tape and reel  
(MSOP8)

SOP8

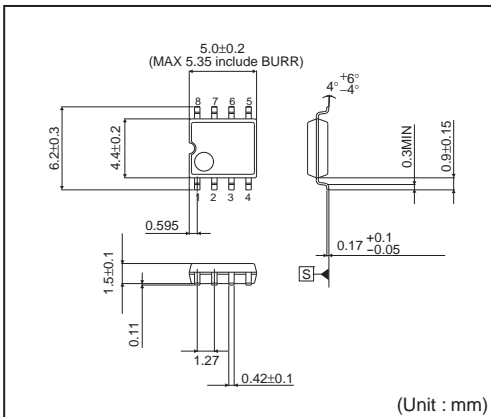

<Tape and Reel information>

Tape	Embossed carrier tape
Quantity	2500pcs
Direction of feed	E2 (The direction is the 1pin of product is at the upper left when you hold reel on the left hand and you pull out the tape on the right hand)

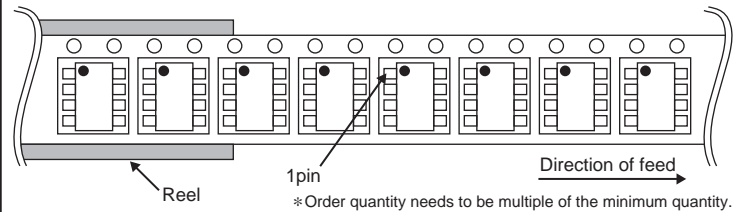

SOP14

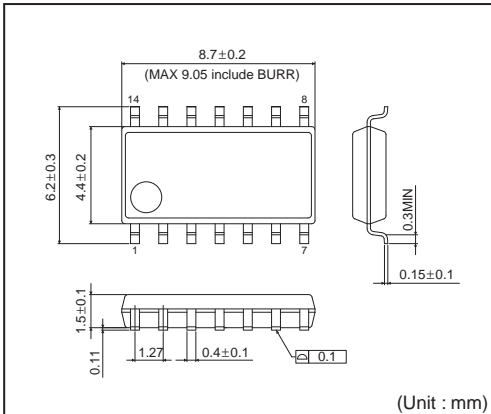

<Tape and Reel information>

Tape	Embossed carrier tape
Quantity	2500pcs
Direction of feed	E2 (The direction is the 1pin of product is at the upper left when you hold reel on the left hand and you pull out the tape on the right hand)

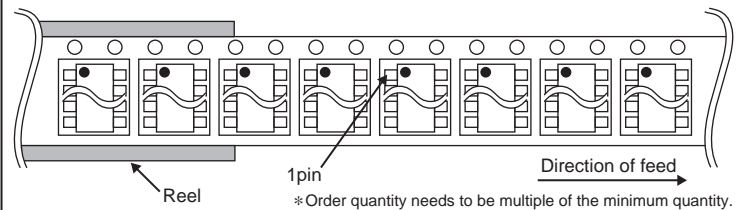



**SSOP-B8**

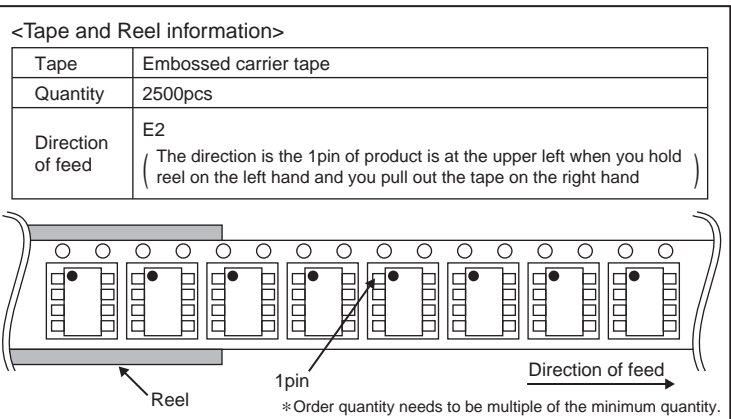
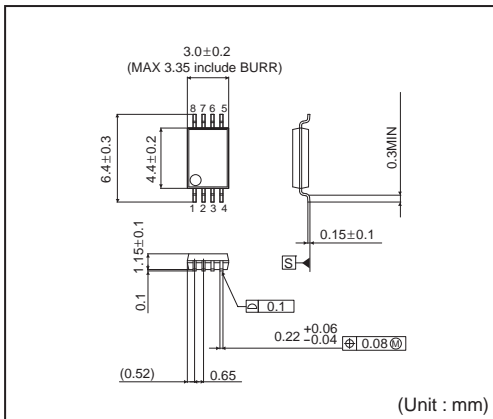

**MSOP8**

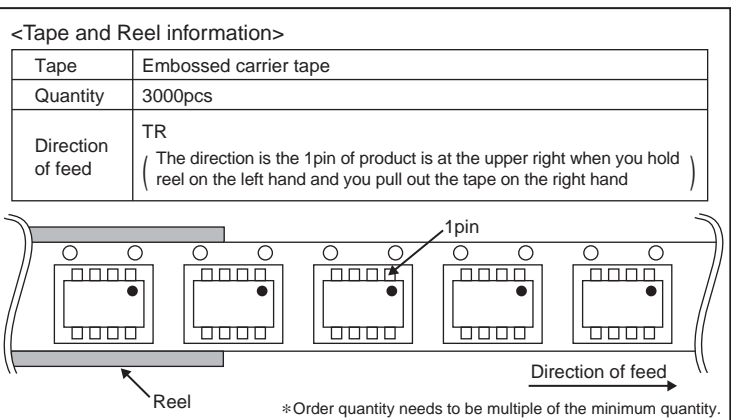
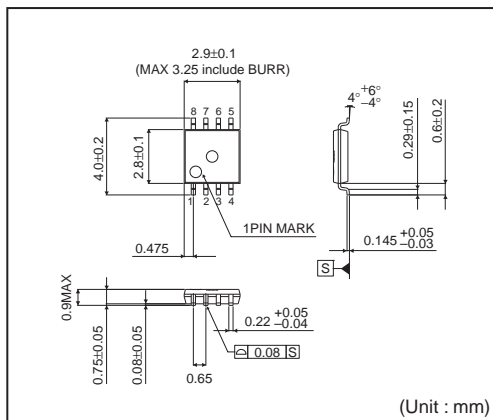

## Notes

No copying or reproduction of this document, in part or in whole, is permitted without the consent of ROHM Co.,Ltd.

The content specified herein is subject to change for improvement without notice.

The content specified herein is for the purpose of introducing ROHM's products (hereinafter "Products"). If you wish to use any such Product, please be sure to refer to the specifications, which can be obtained from ROHM upon request.

Examples of application circuits, circuit constants and any other information contained herein illustrate the standard usage and operations of the Products. The peripheral conditions must be taken into account when designing circuits for mass production.

Great care was taken in ensuring the accuracy of the information specified in this document. However, should you incur any damage arising from any inaccuracy or misprint of such information, ROHM shall bear no responsibility for such damage.

The technical information specified herein is intended only to show the typical functions of and examples of application circuits for the Products. ROHM does not grant you, explicitly or implicitly, any license to use or exercise intellectual property or other rights held by ROHM and other parties. ROHM shall bear no responsibility whatsoever for any dispute arising from the use of such technical information.

The Products specified in this document are intended to be used with general-use electronic equipment or devices (such as audio visual equipment, office-automation equipment, communication devices, electronic appliances and amusement devices).

The Products specified in this document are not designed to be radiation tolerant.

While ROHM always makes efforts to enhance the quality and reliability of its Products, a Product may fail or malfunction for a variety of reasons.

Please be sure to implement in your equipment using the Products safety measures to guard against the possibility of physical injury, fire or any other damage caused in the event of the failure of any Product, such as derating, redundancy, fire control and fail-safe designs. ROHM shall bear no responsibility whatsoever for your use of any Product outside of the prescribed scope or not in accordance with the instruction manual.

The Products are not designed or manufactured to be used with any equipment, device or system which requires an extremely high level of reliability the failure or malfunction of which may result in a direct threat to human life or create a risk of human injury (such as a medical instrument, transportation equipment, aerospace machinery, nuclear-reactor controller, fuel-controller or other safety device). ROHM shall bear no responsibility in any way for use of any of the Products for the above special purposes. If a Product is intended to be used for any such special purpose, please contact a ROHM sales representative before purchasing.

If you intend to export or ship overseas any Product or technology specified herein that may be controlled under the Foreign Exchange and the Foreign Trade Law, you will be required to obtain a license or permit under the Law.



Thank you for your accessing to ROHM product informations.  
More detail product informations and catalogs are available, please contact us.

## ROHM Customer Support System

<http://www.rohm.com/contact/>