

SOP8 Plastic-Encapsulate MOSFETS

CJQ7328 Dual P-Channel MOSFET

$V_{(BR)DSS}$	$R_{DS(on)MAX}$	I_D
-30V	21mΩ@-10V	-8A
	32mΩ@-4.5V	

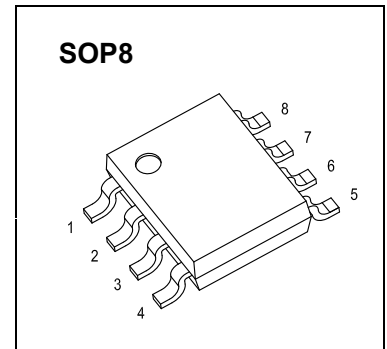

DESCRIPTION

The CJQ7328 uses advanced processing techniques to achieve extremely low on-resistance. This benefit, combined with the ruggedized device design that the MOSFETs are well known for, provides the designer with an extremely efficient and reliable device for use in battery and load management.

FEATURES

Ultra Low On-Resistance

MARKING:

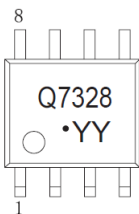

Q7328= Device code
 YY=Date Code
 Solid dot = Pin1 indicator
 Solid dot = Green molding compound device,
 if none,the normal device.

Equivalent Circuit

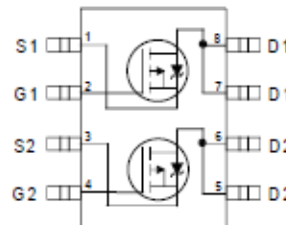

Maximum ratings ($T_a=25^{\circ}C$ unless otherwise noted)

Parameter	Symbol	Value	Unit
Drain-Source Voltage	V_{DS}	-30	V
Gate-Source Voltage	V_{GS}	± 20	
Continuous Drain Current	I_D	-8	A
Pulsed Drain Current (note 1)	I_{DM}	-32	
Power Dissipation (note 2)	P_D	1.4	W
Thermal Resistance from Junction to Ambient (note 2)	$R_{\theta JA}$	89	$^{\circ}C/W$
Junction Temperature	T_J	150	$^{\circ}C$
Storage Temperature	T_{stg}	-55 ~+150	

MOSFET ELECTRICAL CHARACTERISTICS

$T_a=25\text{ }^\circ\text{C}$ unless otherwise specified

Parameter	Symbol	Test Condition	Min	Typ	Max	Unit
Static Characteristics						
Drain Source Breakdown Voltage	$V_{(BR)DSS}$	$V_{GS}=0V, I_D=-250\mu A$	-30			V
Zero Gate Voltage Drain Current	I_{DSS}	$V_{DS}=-24V, V_{GS}=0V$			-15	μA
Gate body Leakage	I_{GSS}	$V_{DS}=0V, V_{GS}=\pm 20V$			± 100	nA
Gate Threshold Voltage	$V_{GS(th)}$	$V_{DS}=V_{GS}, I_D=-250\mu A$	-1	-1.5	-2.5	V
Drain-Source on-state Resistance (note 3)	$R_{DS(on)}$	$V_{GS}=-10V, I_D=-8A$		19	21	m Ω
		$V_{GS}=-4.5V, I_D=-6.8A$		26	32	
Forward Transconductance	g_{Fs}	$V_{DS}=-10V, I_D=-8A$	12			S
Dynamic Characteristics (note 4)						
Input Capacitance	C_{iss}	$V_{DS}=-25V, V_{GS}=0V, f=1MHz$		2675		pF
Output Capacitance	C_{oss}			409		
Reverse Transfer Capacitance	C_{rss}			262		
Total Gate Charge	Q_g	$V_{DS}=-15V, V_{GS}=-10V, I_D=-8A$			78	nC
Gate-Source Charge	Q_{gs}			9.8		
Gate-Drain Charge	Q_{gd}			8.3		
Turn-On Delay Time	$t_{d(on)}$	$V_{DD}=-15V, R_D=15\Omega$ $I_D=-1A, V_{GS}=-10V, R_G=6\Omega$			20	ns
Rise Time	t_r				23	
Turn-Off Delay Time	$t_{d(off)}$				297	
Fall Time	t_f				147	
Drain-Source Body Diode Characteristics						
Diode Forward Voltage (note 3)	V_{SD}	$I_S=-2A, V_{GS}=0V$			-1.2	V

Notes:

1. Repetitive rating : Pulse width limited by junction temperature.
2. Surface mounted on 1"×1" FR4 board, $t \leq 10s$.
3. Pulse Test : Pulse Width $\leq 300\mu s$, Duty Cycle $\leq 2\%$.
4. Guaranteed by design, not subject to production testing.

Typical Characteristics

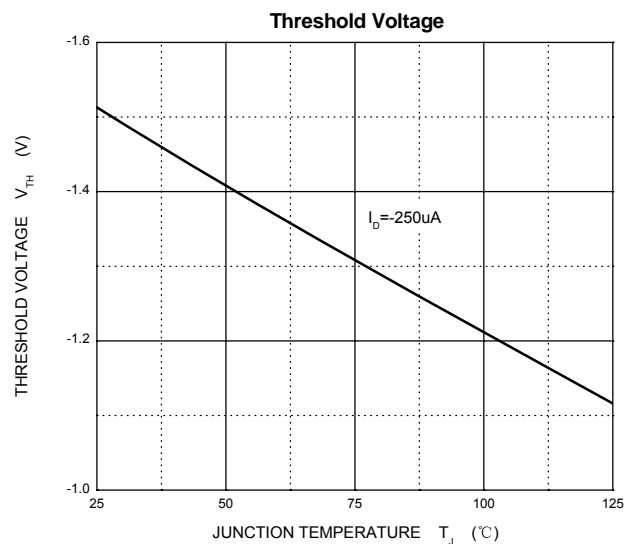
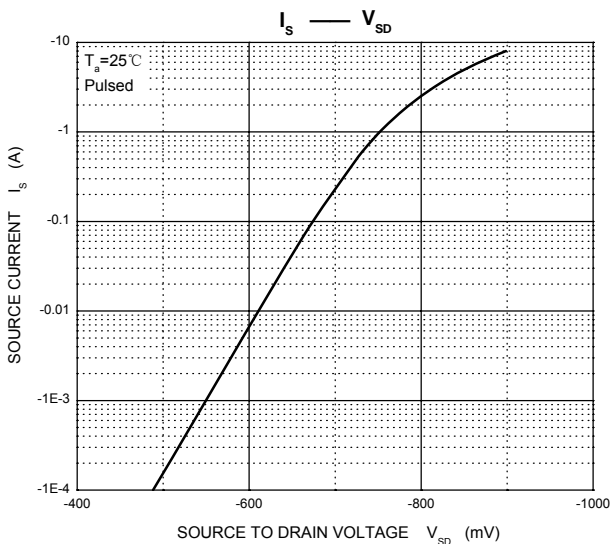
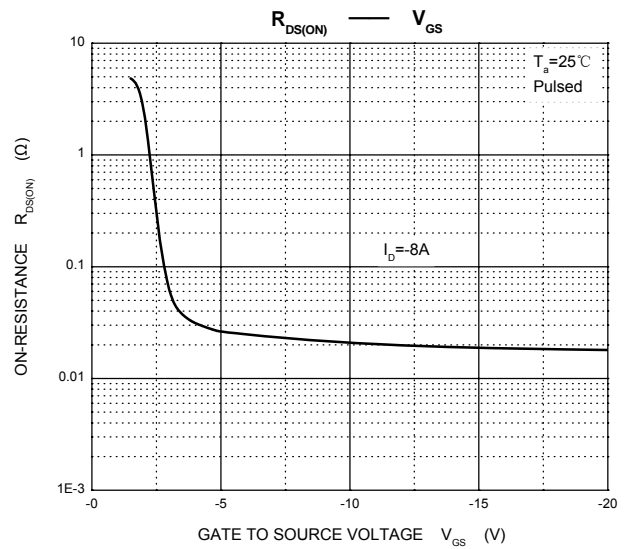
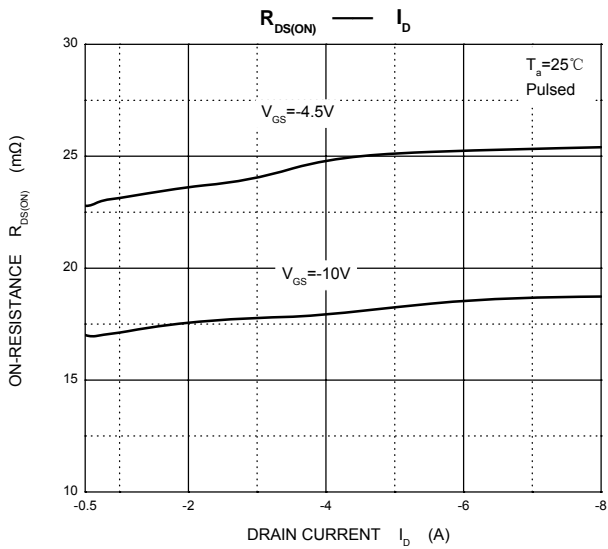
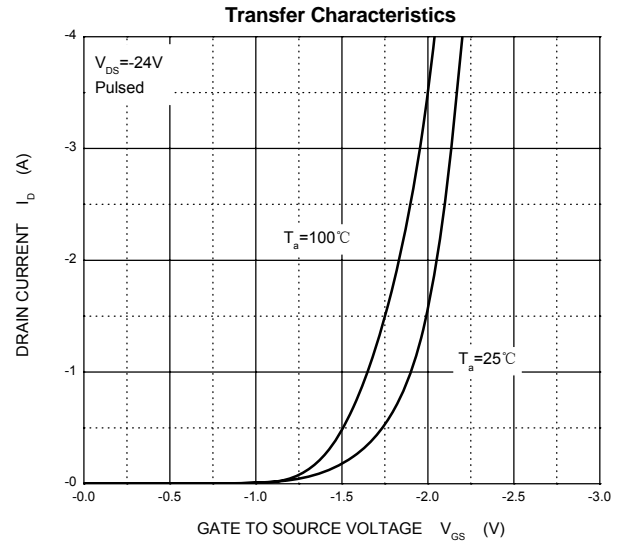
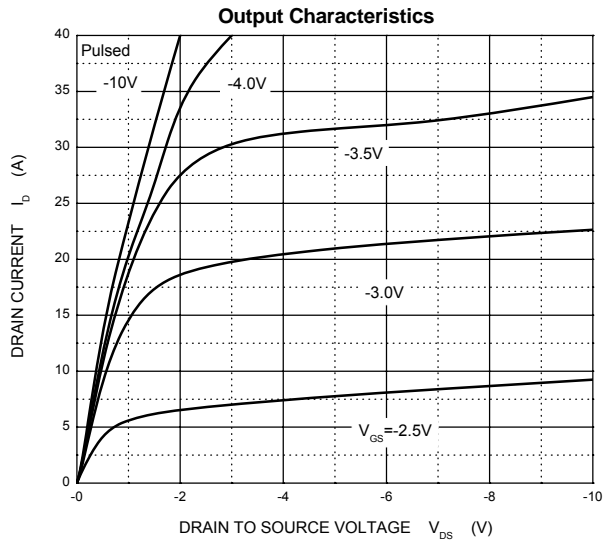

SOP8 Package Outline Dimensions

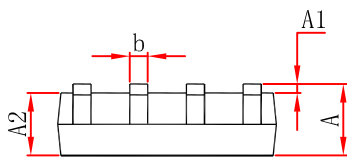
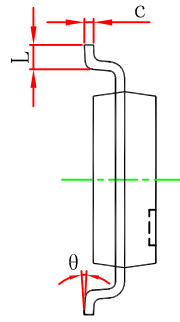
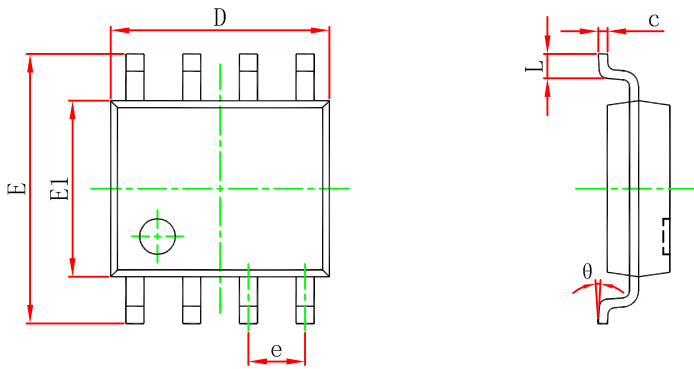

Symbol	Dimensions In Millimeters		Dimensions In Inches	
	Min	Max	Min	Max
A	1.350	1.750	0.053	0.069
A1	0.100	0.250	0.004	0.010
A2	1.350	1.550	0.053	0.061
b	0.330	0.510	0.013	0.020
c	0.170	0.250	0.007	0.010
D	4.800	5.000	0.189	0.197
e	1.270 (BSC)		0.050 (BSC)	
E	5.800	6.200	0.228	0.244
E1	3.800	4.000	0.150	0.157
L	0.400	1.270	0.016	0.050
θ	0°	8°	0°	8°

SOP8 Suggested Pad Layout

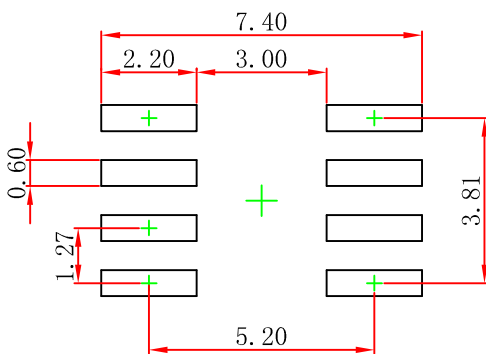

- Note:
1. Controlling dimension: in millimeters.
 2. General tolerance: ± 0.05 mm.
 3. The pad layout is for reference purposes only.

NOTICE

JCET reserve the right to make modifications, enhancements, improvements, corrections or other changes without further notice to any product herein. JCET does not assume any liability arising out of the application or use of any product described herein.

SOP8 Tape and Reel

SOP8 Embossed Carrier Tape

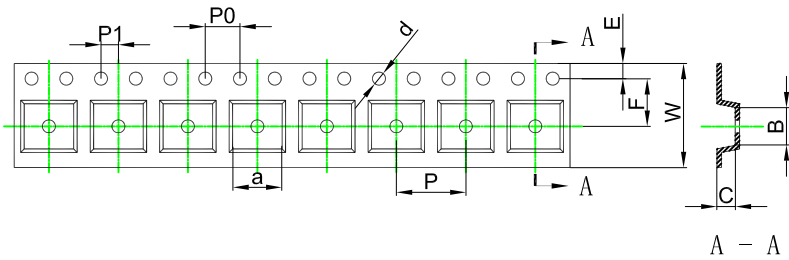

Packaging Description:

SOP8 parts are shipped in tape. The carrier tape is made from a dissipative (carbon filled) polycarbonate resin. The cover tape is a multilayer film (Heat Activated Adhesive in nature) primarily composed of polyester film, adhesive layer, sealant, and anti-static sprayed agent. These reeled parts in standard option are shipped with 2,500 units per 13" or 33cm diameter reel. The reels are clear in color and is made of polystyrene plastic (anti-static coated).

ALL DIM IN mm

Dimensions are in millimeter										
Pkg type	a	B	C	d	E	F	P0	P	P1	W
SOP8	6.40	5.40	2.10	Ø1.50	1.75	5.50	4.00	8.00	2.00	12.00

SOP8 Tape Leader and Trailer

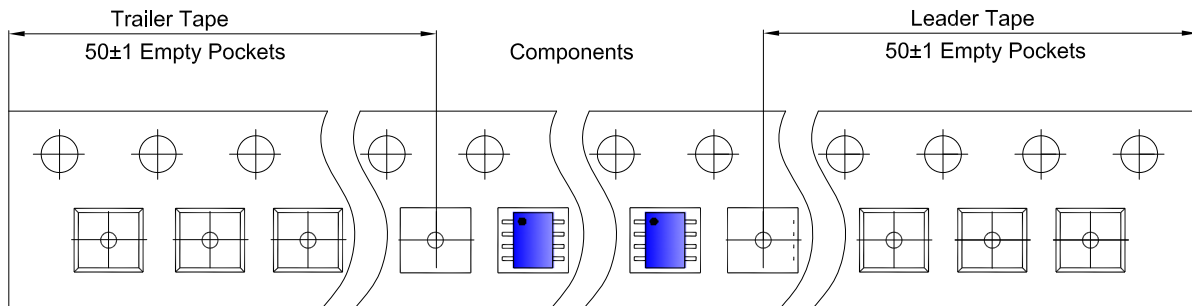

SOP8 Reel

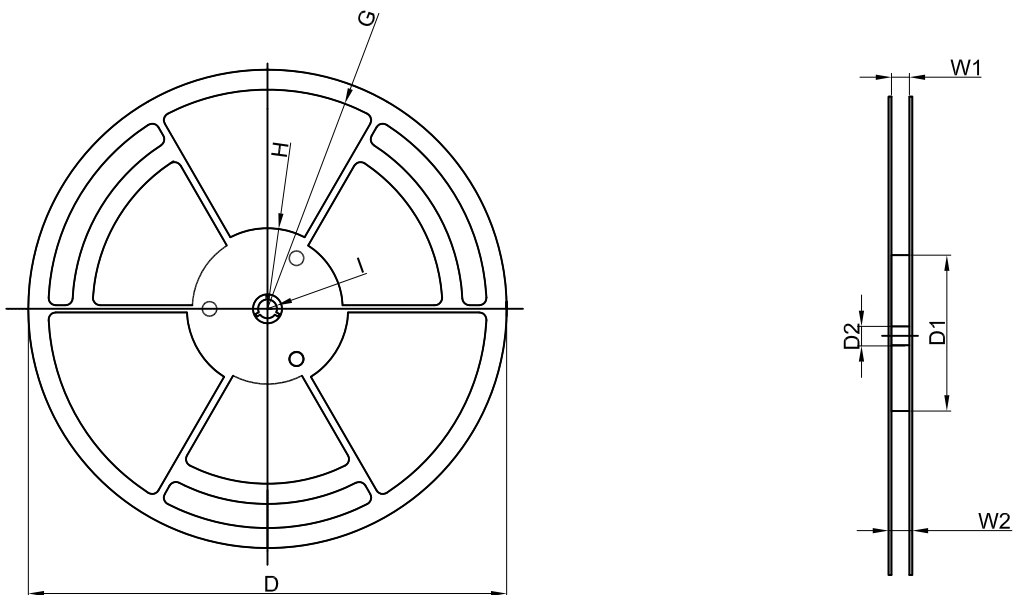

Dimensions are in millimeter								
Reel Option	D	D1	D2	G	H	I	W1	W2
13" Dia	Ø330.00	100.00	13.00	R151.00	R56.00	R6.50	12.40	17.60

REEL	Reel Size	Box	Box Size(mm)	Carton	Carton Size(mm)	G.W.(kg)
2,500 pcs	13 inch	2,500 pcs	336×336×48	20,000 pcs	445×355×365	