

TO-252-2L Plastic-Encapsulate Transistors

MJD122 TRANSISTOR (NPN)

FEATURES

- High DC Current Gain
- Electrically Similar to Popular TIP122
- Built-in a Damper Diode at E-C

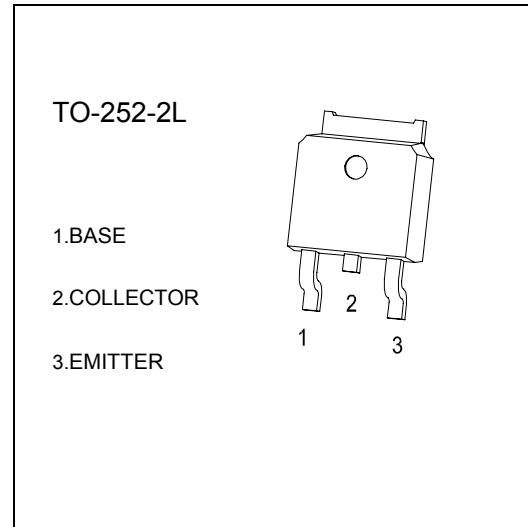

MAXIMUM RATINGS (T_a=25 unless otherwise noted)

Symbol	Parameter	Value	Unit
V _{CB0}	Collector-Base Voltage	100	V
V _{CEO}	Collector-Emitter Voltage	100	V
V _{EBO}	Emitter-Base Voltage	5	V
I _C	Collector Current -Continuous	8	A
P _C	Collector Dissipation	1.5	W
T _J , T _{stg}	Junction and Storage Temperature	-55-150	°C

ELECTRICAL CHARACTERISTICS(T_a=25 °C unless otherwise specified)

Parameter	Symbol	Test conditions	Min	Typ	Max	Unit
Collector-base breakdown voltage	V _{(BR)CBO}	I _C =1mA, I _E =0	100			V
Collector-emitter breakdown voltage	V _{(BR)CEO}	I _C =30mA, I _B =0	100			V
Emitter-base breakdown voltage	V _{(BR)EBO}	I _E =3mA, I _C =0	5			V
Collector cut-off current	I _{CBO}	V _{CB} =100V, I _E =0			10	μA
Collector-emitter cut-off current	I _{CEO}	V _{CE} =50V, I _E =0			10	μA
Emitter cut-off current	I _{EBO}	V _{EB} =5V, I _C =0			2	mA
DC current gain	h _{FE(2)}	V _{CE} =4V, I _C =4A	1000		12000	
	h _{FE(3)}	V _{CE} =4V, I _C =8A	100			
Collector-emitter saturation voltage	V _{CE(sat)1}	I _C =4A, I _B =16mA			2	V
	V _{CE(sat)2}	I _C =8A, I _B =80mA			4	V
Base-emitter saturation voltage	V _{BE(sat)}	I _C =8A, I _B =80mA			4.5	V
Base-emitter voltage*	V _{BE}	V _{CE} =4V, I _C =4A			2.8	V
Collector output capacitance	C _{ob}	V _{CB} =10V, I _E =0, f=0.1MHz			200	pF

Typical Characteristics

MJD122

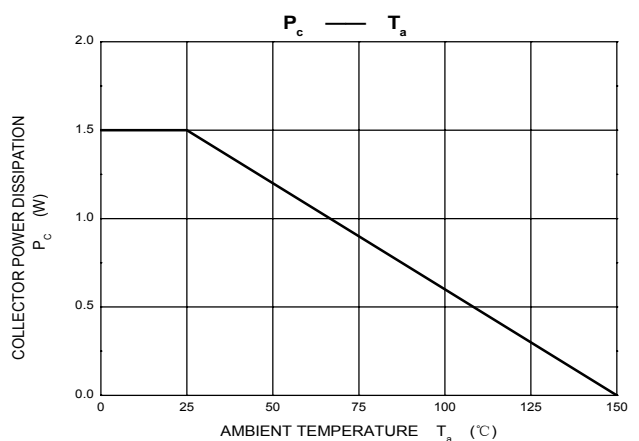
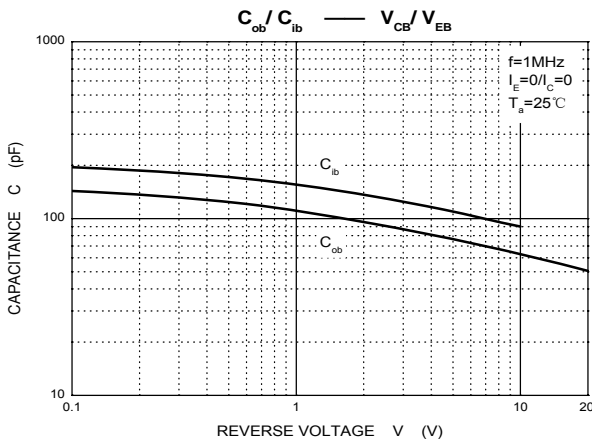
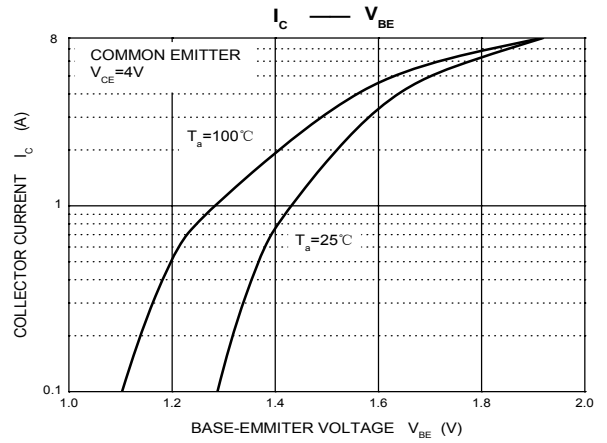
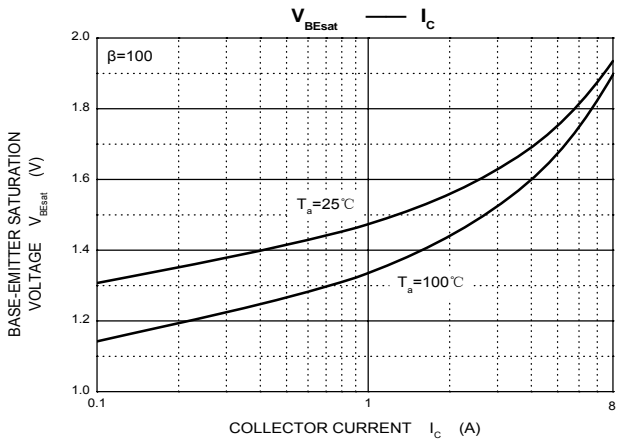
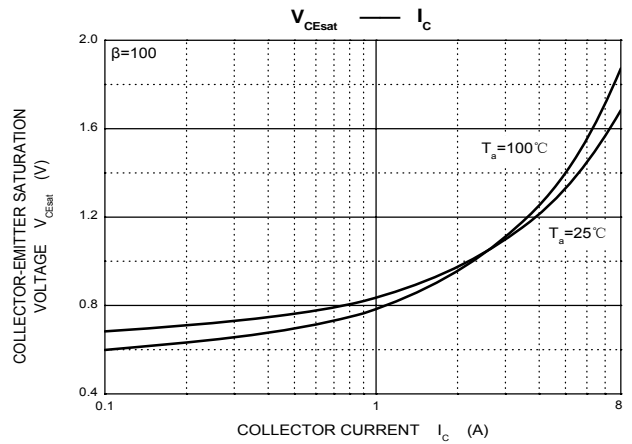
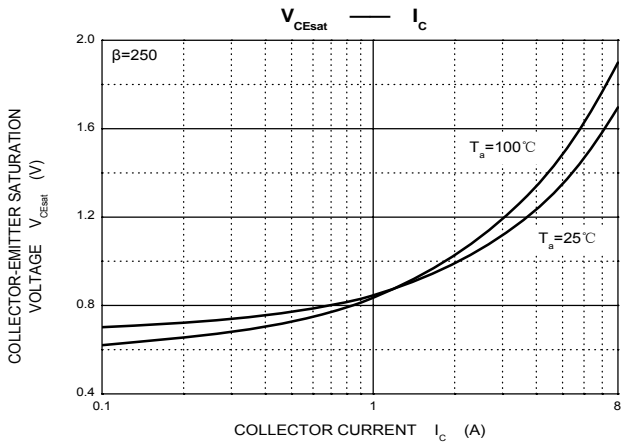
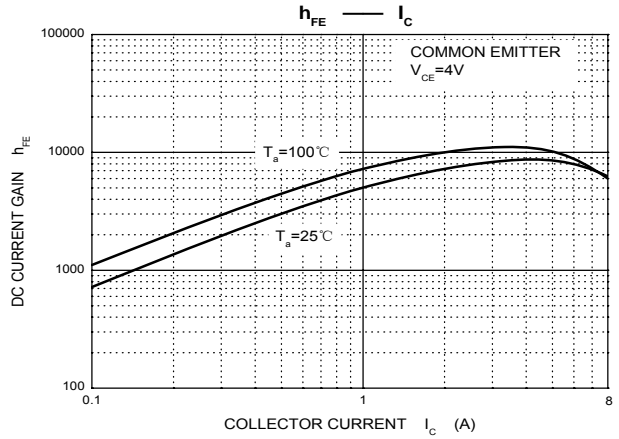
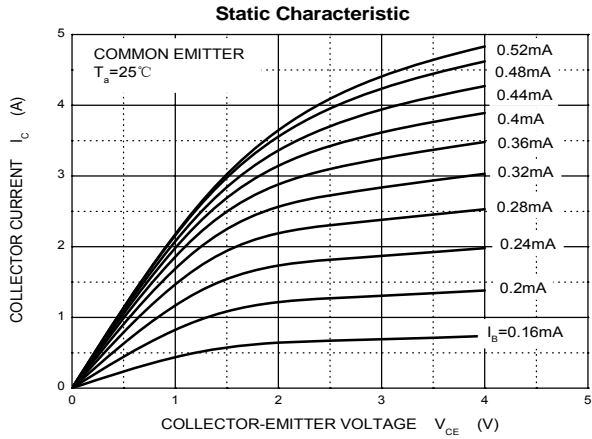

TO-252(4R)-2L Package Outline Dimensions

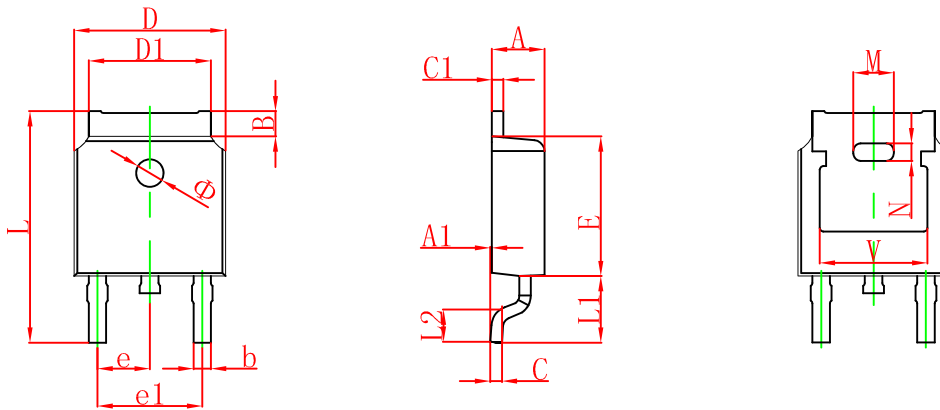

Symbol	Dimensions In Millimeters		Dimensions In Inches	
	Min.	Max.	Min.	Max.
A	2.200	2.380	0.087	0.094
A1	0.000	0.100	0.000	0.004
B	0.800	1.400	0.031	0.055
b	0.710	0.810	0.028	0.032
c	0.460	0.560	0.018	0.022
c1	0.460	0.560	0.018	0.022
D	6.500	6.700	0.256	0.264
D1	5.130	5.460	0.202	0.215
E	6.000	6.200	0.236	0.244
e	2.286 TYP.		0.090 TYP.	
e1	4.327	4.727	0.170	0.186
M	1.778REF.		0.070REF.	
N	0.762REF.		0.018REF.	
L	9.800	10.400	0.386	0.409
L1	2.9REF.		0.114REF.	
L2	1.400	1.700	0.055	0.067
V	4.830 REF.		0.190 REF.	
Φ	1.100	1.300	0.043	0.051

TO-252(4R)-2L Suggested Pad Layout

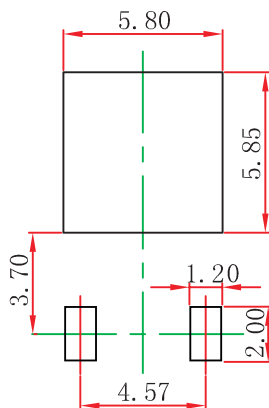

Note:

1. Controlling dimension: in millimeters.
2. General tolerance: $\pm 0.05\text{mm}$.
3. The pad layout is for reference purposes only.

NOTICE

JCET reserve the right to make modifications, enhancements, improvements, corrections or other changes without further notice to any product herein. JCET does not assume any liability arising out of the application or use of any product described herein.

TO-252 Tape and reel

TO-252 Embossed Carrier Tape

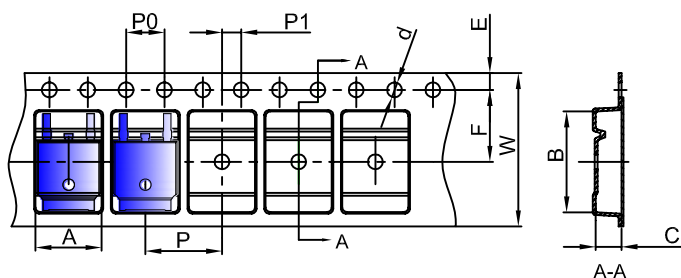

Packaging Description:

TO-252 parts are shipped in tape. The carrier tape is made from a dissipative (carbon filled) polycarbonate resin. The cover tape is a multilayer film (Heat Activated Adhesive in nature) primarily composed of polyester film, adhesive layer, sealant, and anti-static sprayed agent. These reeled parts in standard option are shipped with 25,00 units per 13" or 33.0 cm diameter reel. The reels are clear in color and is made of polystyrene plastic (anti-static coated).

Dimensions are in millimeter										
Pkg type	A	B	C	d	E	F	P0	P	P1	W
TO-252	6.90	10.50	2.70	Ø1.55	1.75	7.50	4.00	8.00	2.00	16.00
(Tolerance)	+/-0.1	+/-0.1	+/-0.1	+/-0.1	+/-0.1	+/-0.1	+/-0.1	+/-0.1	+/-0.1	+0.3/-0.1

TO-252 Tape Leader and Trailer

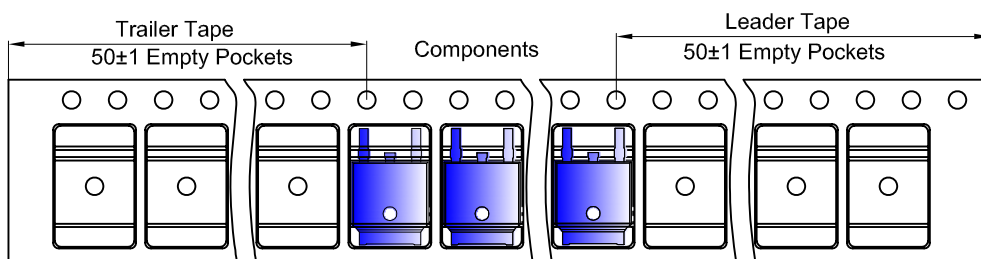

TO-252 Reel

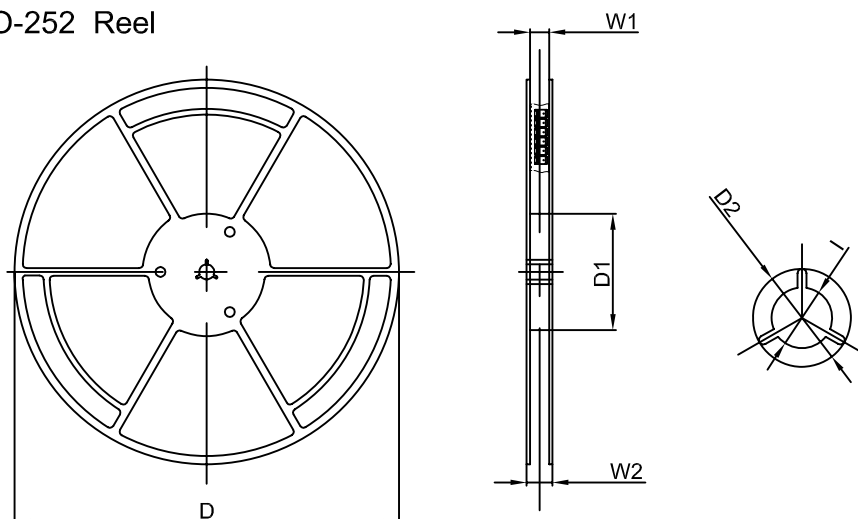

Dimensions are in millimeter						
Reel Option	D	D1	D2	W1	W2	I
13"Dia	330.00	100.00	Ø21.00	16.40	21.00	Ø13.00
Tolerance	+/-2	+/-1	+/-1	+/-1	+/-1	+/-1

REEL	Reel Size	Box	Box Size(mm)	Carton	Carton Size(mm)	G.W.(kg)
2,500 pcs	13inch	2,500 pcs	340×336×29	25,000 pcs	353×346×365	14.04