

1N5817 thru 1N5819

Schottky Barrier Rectifiers Reverse Voltage 20 to 40V Forward Current 1.0A

Feature & Dimensions

- * Plastic package has Underwriters Laboratory Flammability Classification 94V-0
- * Low power loss, high efficiency
- * For use in low voltage high frequency inverters, free wheeling, and polarity protection applications
- * Guarding for over voltage protection
- * High temperature soldering guaranteed: 260°C/10 seconds at terminals

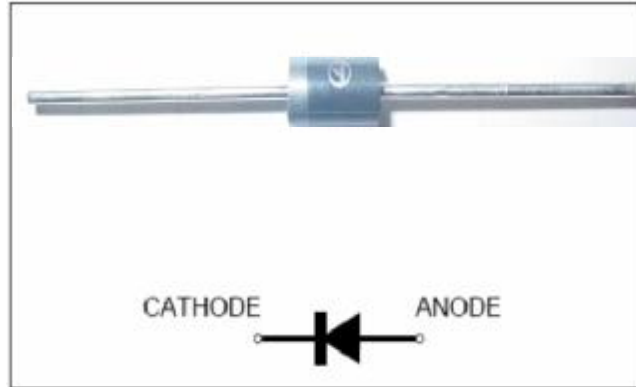

Mechanical Data

Case: JEDEC DO-41, molded plastic over glass DIE

Terminals: Plated axial leads, solderable per MIL-STD-750, Method 2026

Polarity: Color band denotes cathode end

Mounting Position: Any

Weight: 0.011 oz., 0.284 g

Handling precaution: None

We declare that the material of product compliance with ROHS requirements

1. Maximum & Thermal Characteristics Ratings at 25°C ambient temperature unless otherwise specified.

Parameter Symbol	symbol	1N5817	1N5818	1N5819	Unit
device marking code		1N5817	1N5818	1N5819	
Maximum repetitive peak reverse voltage	V_{RRM}	20	30	40	V
Maximum RSM voltage	V_{RSM}	14	21	28	V
Maximum DC blocking voltage	V_{DC}	20	30	40	V
Maximum average forward rectified current 0.375" (9.5mm) lead length (See fig. 1)	$I_{F(AV)}$	1.0			A
Peak forward surge current 8.3ms single half sine-wave superimposed on rated load (JEDEC Method)	I_{FSM}	25			A
Typical thermal resistance (Note 1)	$R_{\theta JA}$	50			°C/W
Operating temperature range	T_J	-40 to +150			°C
storage temperature range	T_{STG}	-40 to +175			°C

Electrical Characteristics Ratings at 25°C ambient temperature unless otherwise specified.

Parameter Symbol	symbol	1N5817	1N5818	1N5819	Unit
Maximum instantaneous forward voltage at 1.0A	V_F	0.45	0.55		V
Maximum DC reverse current $T_A = 25^\circ\text{C}$ at rated DC blocking voltage $T_A = 100^\circ\text{C}$	I_R	1.0 10			mA
Typical junction capacitance at 4.0V, 1MHz	C_J	110			PF

NOTES:

1. Thermal resistance from junction to ambient at 0.375" (9.5mm) lead length, P.C.B. mounted

1N5817 thru 1N5819

2. Characteristic Curves (TA = 25°C unless otherwise noted)

Fig. 1 - Forward Current Derating Curve

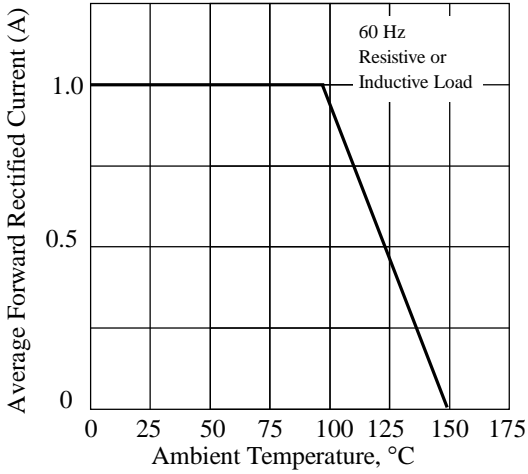

Fig. 2 - Maximum Non-repetitive Peak Forward Surge Current

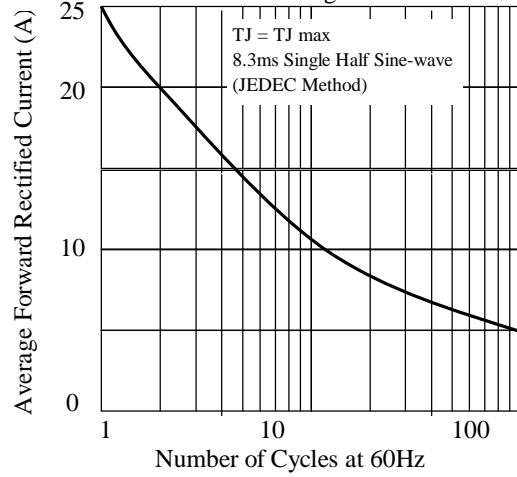

Fig. 3 - Typical Instantaneous Forward Characteristics

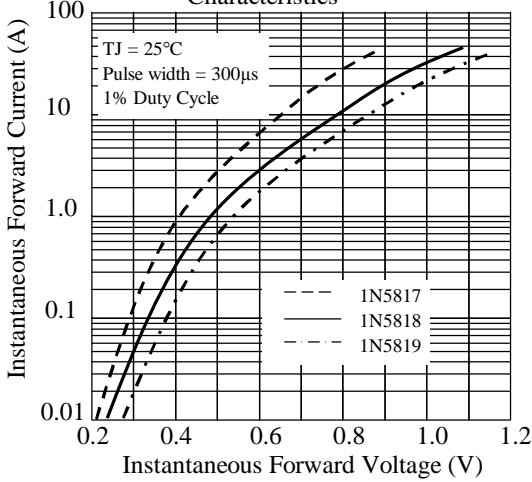

Fig. 4 - Typical Reverse Characteristics

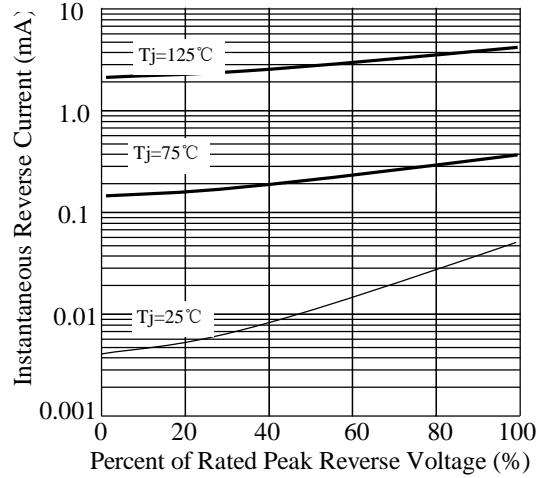

Fig. 5 - typical transient thermal impedance

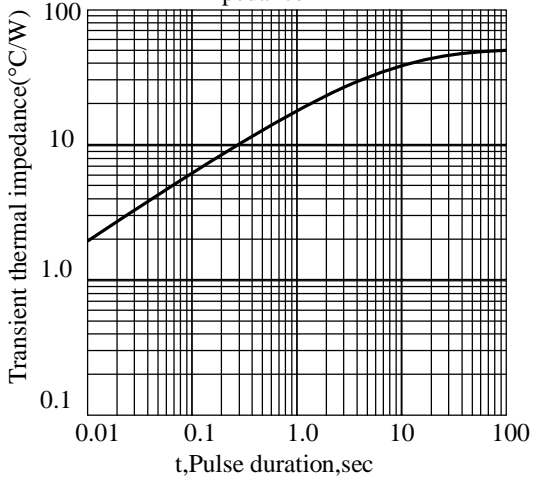
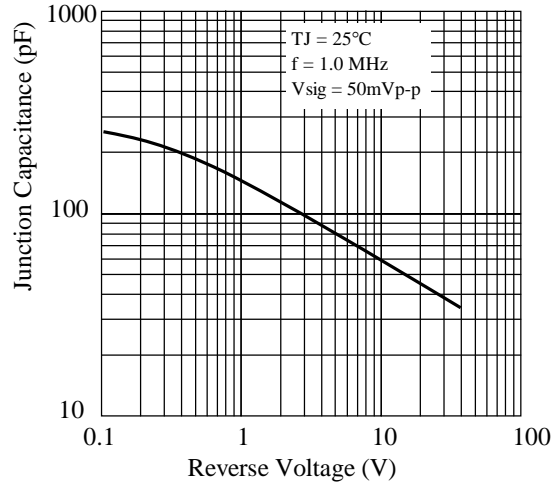
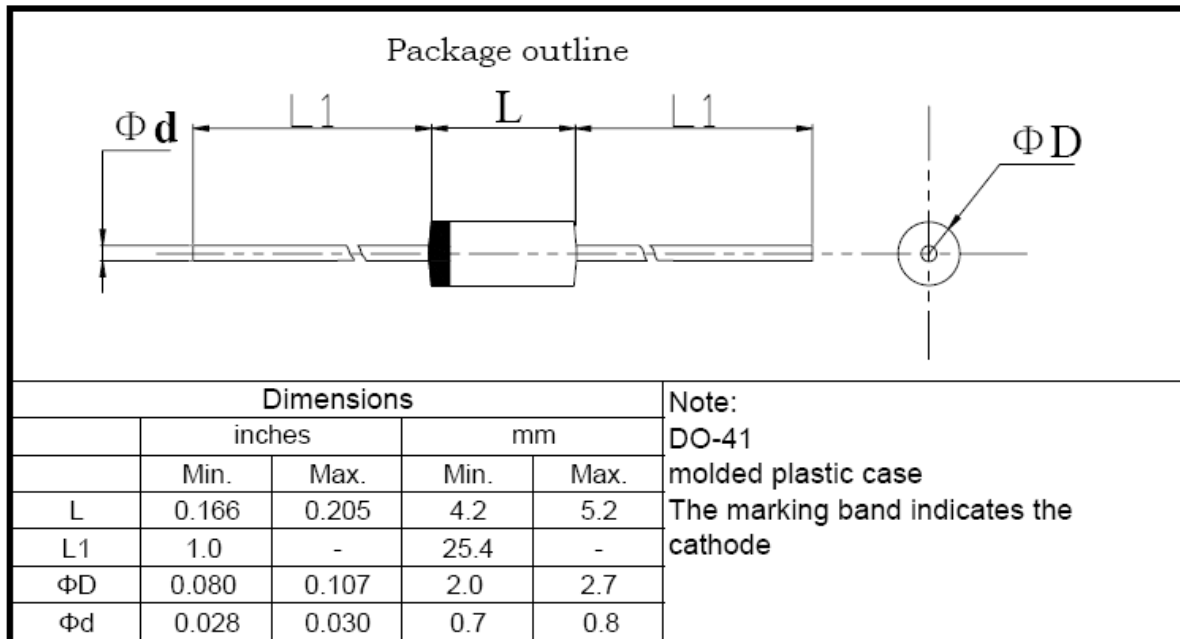

Fig. 6 - Typical Junction Capacitance



1N5817 thru 1N5819

3. dimension:



标题： 塑封生产线轴向产品包装规范	文件编号：WI-250
	第 4 版 第 0 次修改
	第 1 页

1 弹带盒装 ammo and box

1.1. 弹带盒规格 ammo spec.

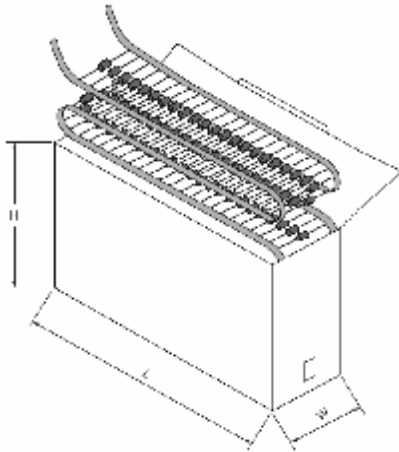

单位：mm

	L	W	H
T52	262±2	76±2	90±2
T42	262±2	64±2	90±2
T26	250±3	45±3	95±3

1.2 弹带内盒要求 inner box spec.

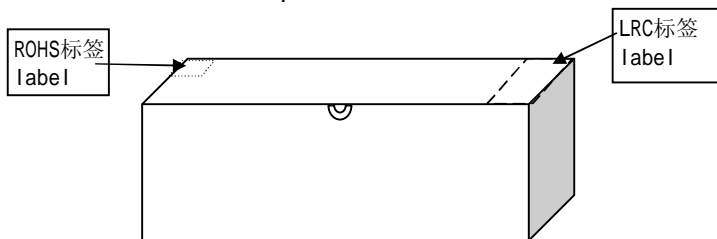

标题: 塑封生产线轴向产品包装规范	文件编号: WI-250
	第 4 版 第 0 次修改
	第 2 页

1.4 标签要求 label spec.

1.4.1 LRC标签 LRC label

成型 FORMING ***** ← 成型规格 forming spec.

型号 TYPE ***** ← LRC产品型号 type

重复峰压 (V) PRV (V)	****	← 产品重复峰压值 peak repetitive voltage
额定电流 (A) I _o (A)	**	← 产品额定电流值 average output current
数量 (只) QTY (pcs)	****	← 产品数量 quantity
检验员 CHECKER	02	
日期: DATE:	*****	← 产品生产日期 date

1.4.2 环保标签 environmental protection label



2. 外箱规格 carton spec.

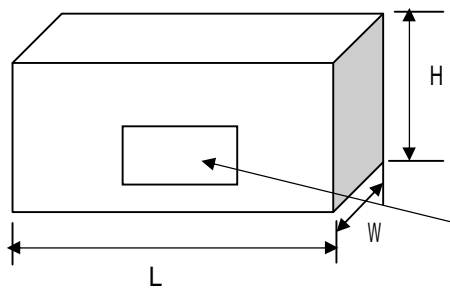

单位: mm

	L	W	H
T52	430±2	280±2	225±2
T42	410±2	285±2	300±2
T26	435±3	280±3	295±3

外箱标签 carton label

3 按以上包装方式, 编带数量和外包装箱产品数量: typing and carton spec.

	塑封外型			
	A-405 & DO-41 & R-1	R-3	DO-15	DO-201AD
每根编带数量 quantity/ammo	3K	1.8K	2K(T52) 1.8K(T26)	0.8K
外箱数量 (T52编带) quantity/cartoon	30K	18K	20K	8.0K
外箱数量 (T26编带) quantity/cartoon	60K	36K	36K	-
外箱数量 (T42编带) quantity/cartoon	54K	32.4K	36K	-

标题:

塑封生产线轴向产品包装规范

文件编号: WI-250

第 4 版 第 0 次修改

第 3 页

4 编带规格 brede spec

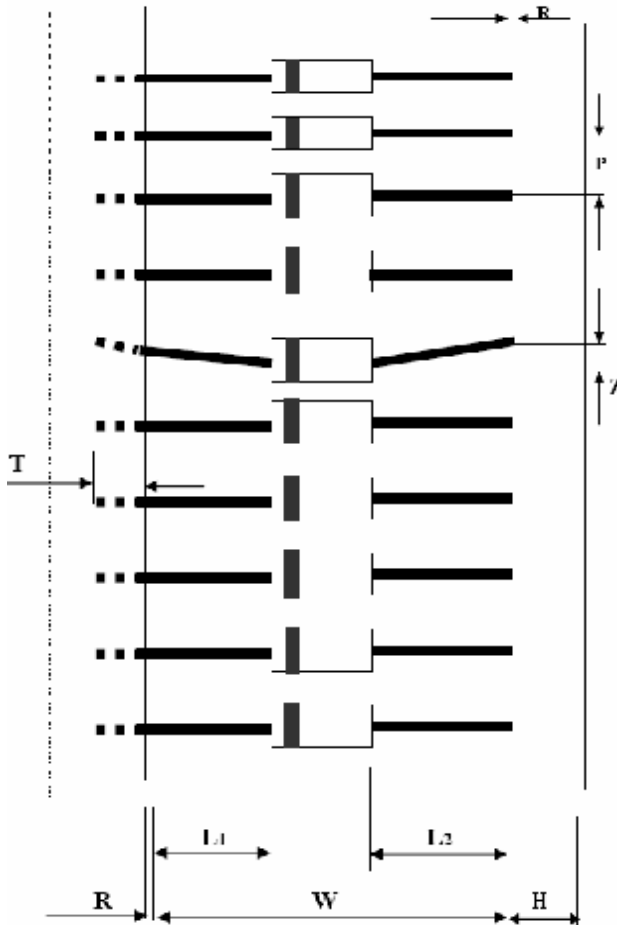

尺寸代号	编带尺寸 typing dimension					
	26/tape	35/tape	40/tape	42/tape	52/tape	52/tape#
W	26 0.0/+1.6	35 -1.0/+0.5	40 -1.0/+0.5	42 -1.0/+1.0	52 -1.0/+2.0	52 -1.0/+2.0
P	5±0.5	5±0.5	5±0.5	5±0.5	5±0.5	10±0.5
L1-L2	<1.0	<1.0	<1.0	<1.0	<1.0	<1.0
H	6±1.0	6±1.0	6±1.0	6±1.0	6±1.0	6±1.0
Z	<1.0	<1.0	<1.0	<1.0	<1.0	<1.0
R	<1.0	<1.0	<1.0	<1.0	<1.0	<1.0
T	>3.5	>3.5	>3.5	>3.5	>3.5	>3.5

注: 52编带# 为DO-201AD编带规格 "52编带#" just for D0-201AD

1. 红白编带厚度为0.05mm; 两种胶带各自之间无明显色差; 编带要求均为胶带。
The typing thickness is 0.05mm and color is obvious difference
2. 两端引带20~40cm. Typing lead over 20~40cm
3. 红色编带一端为二极管“负极”; 白色编带一端为二极管“正极”。
red color is cathode ,white color is anode
4. 无卤 green epoxy compound (无卤产品才贴HF only)

Green

1N5817 thru 1N5819

4. Update Record

版次	更新记录	更新作者	更新日期
1	第一版	余波	2010.5.26
2	调整结温为150度	周杰	2010.09.24
3	增加包装规范; 调整编带L1-L2为小于1.0mm	周杰	2011.08.12