



# UT2305

**Power MOSFET**

## 4.2A, 20V P-CHANNEL POWER MOSFET

■ DESCRIPTION

The UTC **UT2305** is P-channel enhancement mode power MOSFET, designed in serried ranks. With fast switching speed, low on-resistance, favorable stabilization.

Used in commercial and industrial surface mount applications and suited for low voltage applications such as DC/DC converters.

■ SYMBOL

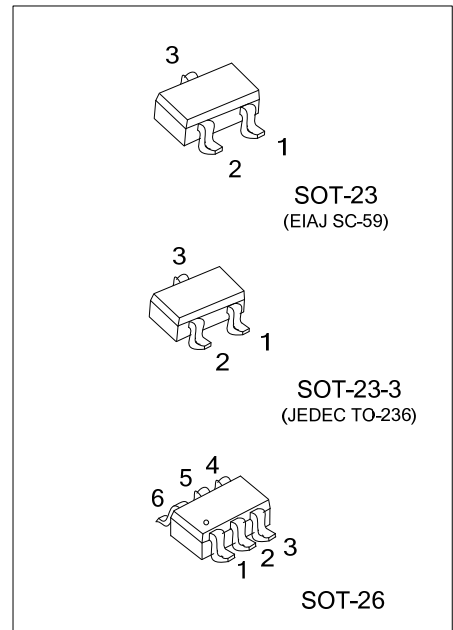
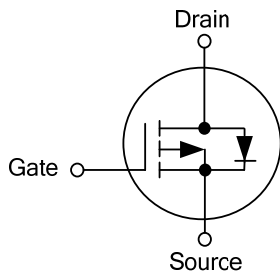

■ ORDERING INFORMATION

Ordering Number	Package	Pin Assignment						Packing
		1	2	3	4	5	6	
UT2305G-AE2-R	SOT-23-3	S	G	D	-	-	-	Tape Reel
UT2305G-AE3-R	SOT-23	S	G	D	-	-	-	Tape Reel
UT2305G-AG3-R	SOT-26	D	D	G	S	D	D	Tape Reel

Note: Pin Assignment: G: Gate D: Drain S: Source

<p>UT2305G-AE3-R</p>	<p>(1) R: Tape Reel</p> <p>(2) AE2: SOT-23-3, AE3: SOT-23, AG6: SOT-26</p> <p>(3) G: Halogen Free and Lead Free</p>
----------------------	---

■ MARKING

SOT-23 / SOT-23-3	SOT-26

## ■ ABSOLUTE MAXIMUM RATINGS

PARAMETER	SYMBOL	RATING	UNITS
Drain-Source Voltage	$V_{DS}$	- 20	V
Gate-Source Voltage	$V_{GS}$	$\pm 12$	V
Continuous Drain Current (Note 3) ( $T_A=25^\circ\text{C}$ )	$I_D$	-4.2	A
Pulsed Drain Current (Note 1, 2)	$I_{DM}$	-10	A
Power Dissipation ( $T_A=25^\circ\text{C}$ )	SOT-23-3	0.83	W
	SOT-23	1.38	W
	SOT-26	1.1	W
Junction Temperature	$T_J$	+150	$^\circ\text{C}$
Storage Temperature	$T_{STG}$	-55 ~ +150	$^\circ\text{C}$

Note: Absolute maximum ratings are those values beyond which the device could be permanently damaged. Absolute maximum ratings are stress ratings only and functional device operation is not implied.

## ■ THERMAL DATA

PARAMETER	SYMBOL	RATING	UNIT
Junction to Ambient (Note 3)	SOT-23-3	150	$^\circ\text{C/W}$
	SOT-23	90	$^\circ\text{C/W}$
	SOT-26	110	$^\circ\text{C/W}$

## ■ ELECTRICAL CHARACTERISTICS ( $T_J=25^\circ\text{C}$ , unless otherwise specified)

PARAMETER	SYMBOL	TEST CONDITIONS	MIN	TYP	MAX	UNIT
<b>OFF CHARACTERISTICS</b>						
Drain-Source Breakdown Voltage	$BV_{DSS}$	$V_{GS}=0V, I_D=-250\mu\text{A}$	-20			V
Drain-Source Leakage Current	$I_{DSS}$	$V_{DS}=-20V, V_{GS}=0V$			-1	$\mu\text{A}$
Gate-Source Leakage Current	$I_{GSS}$	$V_{GS}=\pm 12V, V_{DS}=0V$			$\pm 100$	nA
Breakdown Voltage Temperature Coefficient	$\Delta BV_{DSS}/\Delta T_J$	Reference to $25^\circ\text{C}, I_D=-1\text{mA}$		-0.1		$\text{V}/^\circ\text{C}$
<b>ON CHARACTERISTICS</b>						
Gate Threshold Voltage	$V_{GS(TH)}$	$V_{DS}=V_{GS}, I_D=-250\mu\text{A}$	-0.5		-1.2	V
Drain-Source On-State Resistance (Note 2)	$R_{DS(ON)}$	$V_{GS}=-10V, I_D=-4.5\text{A}$			53	$\text{m}\Omega$
		$V_{GS}=-4.5V, I_D=-4.2\text{A}$			65	$\text{m}\Omega$
		$V_{GS}=-2.5V, I_D=-2.0\text{A}$			100	$\text{m}\Omega$
		$V_{GS}=-1.8V, I_D=-1.0\text{A}$			250	$\text{m}\Omega$
<b>DYNAMIC CHARACTERISTICS</b>						
Input Capacitance	$C_{ISS}$	$V_{GS}=0V, V_{DS}=-15V, f=1\text{MHz}$		900		pF
Output Capacitance	$C_{OSS}$			116		pF
Reverse Transfer Capacitance	$C_{RSS}$			120		pF
<b>SWITCHING CHARACTERISTICS</b>						
Turn-ON Delay Time (Note 2)	$t_{D(ON)}$	$V_{DS}=-15V, V_{GS}=-10V, I_D=-1\text{A}, R_G=6\Omega, R_D=15\Omega$		12		ns
Turn-ON Rise Time	$t_R$			36		ns
Turn-OFF Delay Time	$t_{D(OFF)}$			326		ns
Turn-OFF Fall Time	$t_F$			200		ns
Total Gate Charge (Note 2)	$Q_G$	$V_{DS}=-16V, V_{GS}=-4.5V, I_D=-4.2\text{A}$		30		nC
Gate-Source Charge	$Q_{GS}$			5		nC
Gate-Drain Charge	$Q_{GD}$			2.5		nC
<b>SOURCE- DRAIN DIODE RATINGS AND CHARACTERISTICS</b>						
Drain-Source Diode Forward Voltage(Note2)	$V_{SD}$	$V_{GS}=0V, I_S=-1.2\text{A}$			-1.2	V
Reverse Recovery Time	$t_{rr}$	$V_{GS}=0V, I_S=-4.2\text{A}, dl/dt=100\text{A}/\mu\text{s}$		27.7		ns
Reverse Recovery Charge	$Q_{RR}$			22		nC

Notes: 1. Pulse width limited by  $T_{J(MAX)}$

2. Pulse width  $\leq 300\mu\text{s}$ , duty cycle  $\leq 2\%$ .

3. Surface mounted on 1 in<sup>2</sup> copper pad of FR4 board;  $270^\circ\text{C/W}$  when mounted on min.

■ TYPICAL CHARACTERISTICS

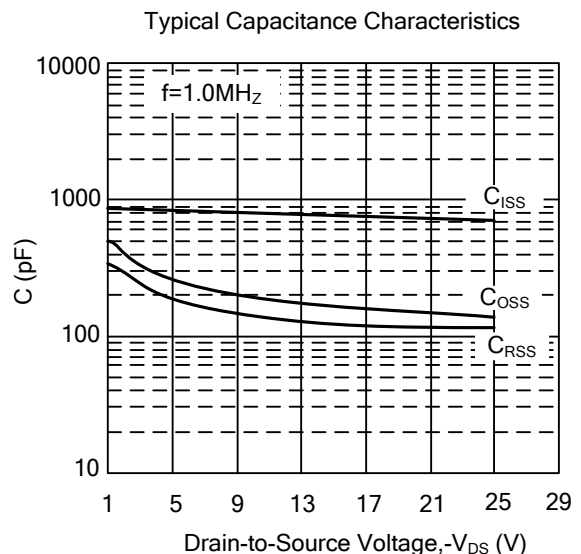
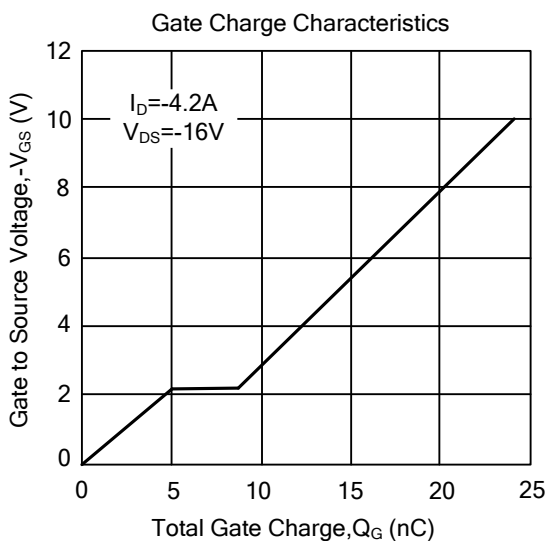
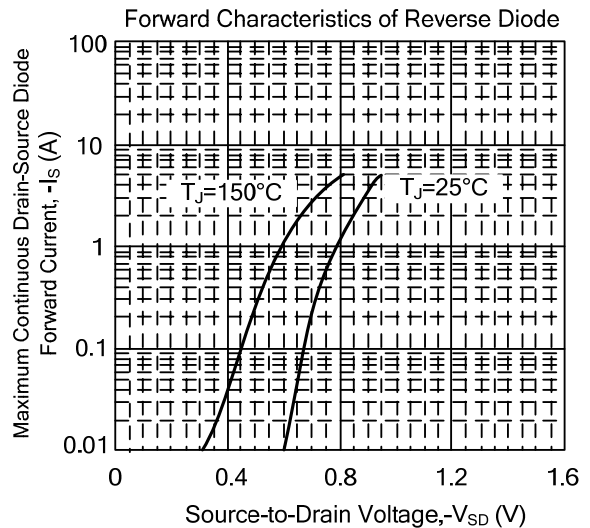
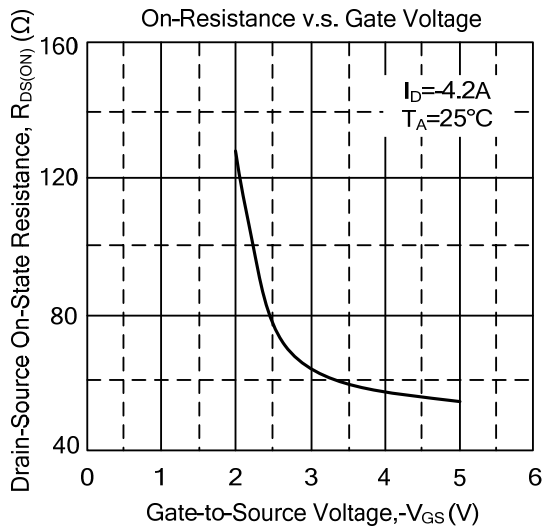
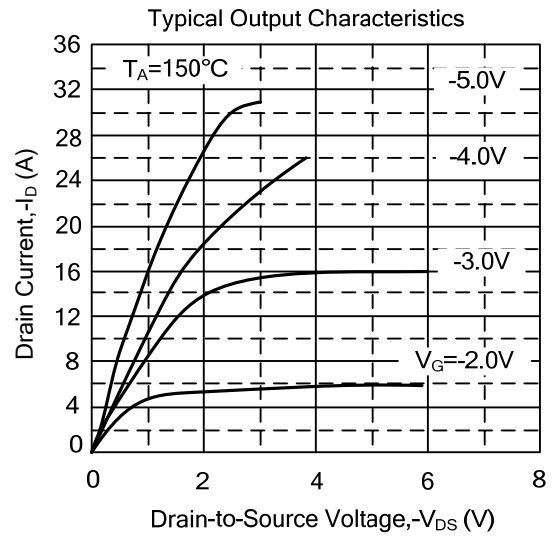
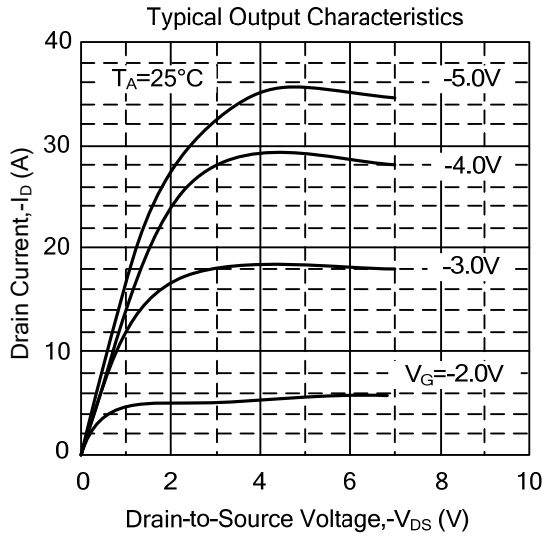

■ TYPICAL CHARACTERISTICS(Cont.)

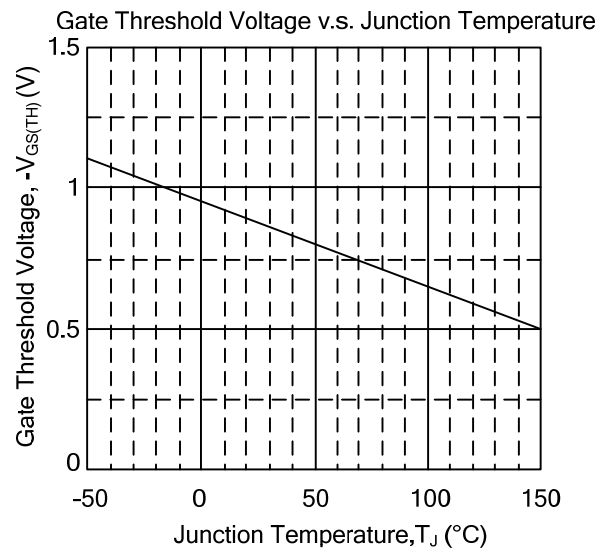
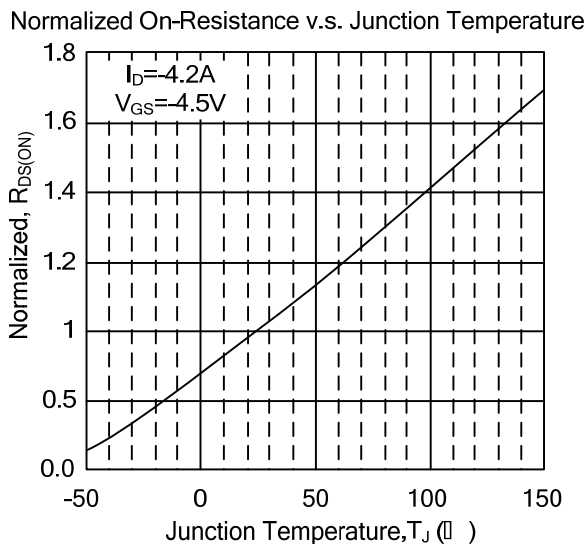
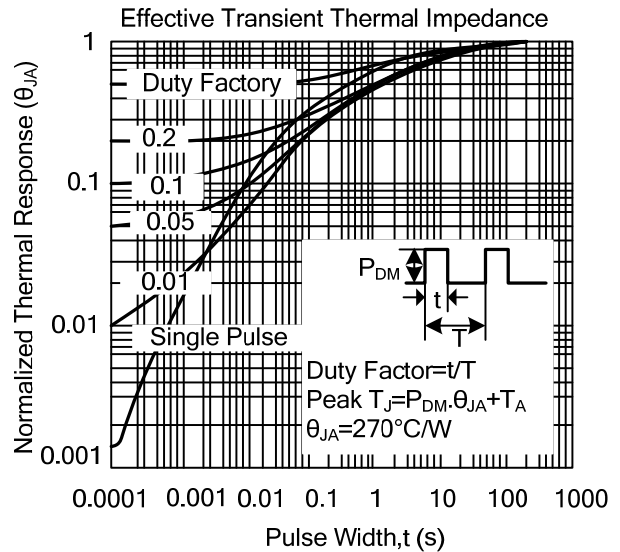
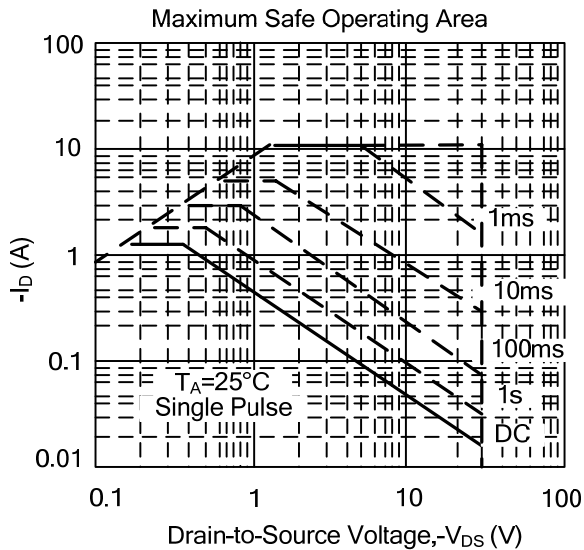

UTC assumes no responsibility for equipment failures that result from using products at values that exceed, even momentarily, rated values (such as maximum ratings, operating condition ranges, or other parameters) listed in products specifications of any and all UTC products described or contained herein. UTC products are not designed for use in life support appliances, devices or systems where malfunction of these products can be reasonably expected to result in personal injury. Reproduction in whole or in part is prohibited without the prior written consent of the copyright owner. The information presented in this document does not form part of any quotation or contract, is believed to be accurate and reliable and may be changed without notice.