



2SD1857

NPN EPITAXIAL SILICON TRANSISTOR

POWER TRANSISTOR

■ **FEATURES**

- * High breakdown voltage. ($BV_{CEO}=120V$)
- * Low collector output capacitance. (Typ. 20pF at $V_{CB}=10V$)
- * High transition frequency. ($f_T=80MHz$)

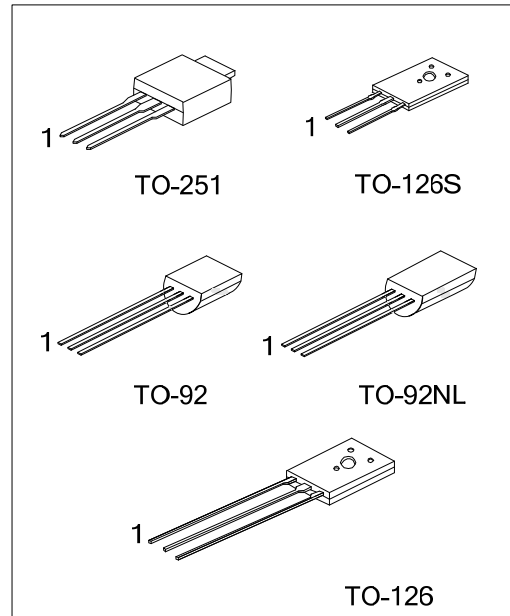

■ **ORDERING INFORMATION**

Ordering Number		Package	Pin Assignment			Packing
Lead Free	Halogen Free		1	2	3	
2SD1857L-x-T60-K	2SD1857G-x-T60-K	TO-126	E	C	B	Bulk
2SD1857L-x-T6S-K	2SD1857G-x-T6S-K	TO-126S	E	C	B	Bulk
2SD1857L-x-TM3-T	2SD1857G-x-TM3-T	TO-251	E	C	B	Tube
2SD1857L-x-T92-B	2SD1857G-x-T92-B	TO-92	E	C	B	Tape Box
2SD1857L-x-T92-K	2SD1857G-x-T92-K	TO-92	E	C	B	Bulk
2SD1857L-x-T9N-B	2SD1857G-x-T9N-B	TO-92NL	E	C	B	Tape Box
2SD1857L-x-T9N-K	2SD1857G-x-T9N-K	TO-92NL	E	C	B	Bulk

Note: Pin Assignment: E: Emitter C: Collector B: Base

<p>2SD1857L-x-T60-K</p> <p>(1) Packing Type (2) Package Type (3) Rank (4) Lead Free</p>	<p>(1) B: Tape Box, K: Bulk, T: Tube (2) T60: TO-126, T6S: TO-126S, TM3: TO-251 T92: TO-92, T9N: TO-92NL (3) x: refer to Classification of h_{FE} (4) L: Lead Free, G: Halogen Free</p>
---	--

■ MARKING

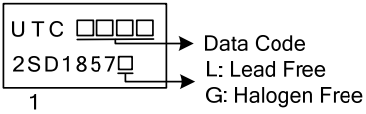
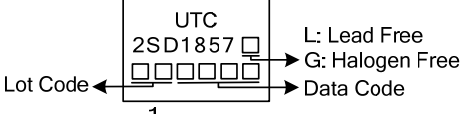
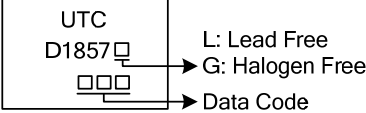
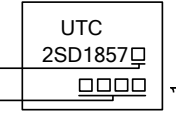
TO-126 / TO-126C	TO-251
 <p>UTC □□□□ 2SD1857□ 1</p> <p>→ Data Code → L: Lead Free → G: Halogen Free</p>	 <p>UTC 2SD1857□ □□□□□ 1</p> <p>→ L: Lead Free → G: Halogen Free → Data Code ← Lot Code</p>
TO-92	TO-92NL
 <p>UTC D1857□ □□ 1</p> <p>→ L: Lead Free → G: Halogen Free → Data Code</p>	 <p>UTC 2SD1857□ □□□ 1</p> <p>← L: Lead Free ← G: Halogen Free ← Data Code</p>

■ ABSOLUTE MAXIMUM RATING ($T_A=25^{\circ}\text{C}$, unless otherwise specified)

PARAMETER		SYMBOL	RATINGS	UNIT
Collector-Base Voltage		V_{CB0}	120	V
Collector-Emitter Voltage		V_{CEO}	120	V
Emitter-Base Voltage		V_{EBO}	5	V
Collector Power Dissipation	TO-126/TO-126S	P_C	1.4	W
	TO-92		0.625	
	TO-92 NL		0.9	
	TO-251		2	
Collector Current		I_C	2	A
Collector Current		I_{CP}	3	A
Junction Temperature		T_J	+150	$^{\circ}\text{C}$
Storage Temperature		T_{STG}	-40 ~ +150	$^{\circ}\text{C}$

Note: Absolute maximum ratings are those values beyond which the device could be permanently damaged.

Absolute maximum ratings are stress ratings only and functional device operation is not implied.

■ ELECTRICAL CHARACTERISTICS ($T_A=25^{\circ}\text{C}$)

PARAMETER	SYMBOL	TEST CONDITIONS	MIN	TYP	MAX	UNIT
Collector-Base Breakdown Voltage	BV_{CB0}	$I_C=50\mu\text{A}$	120			V
Collector-Emitter Breakdown Voltage	BV_{CEO}	$I_C=1\text{mA}$	120			V
Emitter-Base Breakdown Voltage	BV_{EBO}	$I_E=50\mu\text{A}$	5			V
Collector Cut-Off Current	I_{CBO}	$V_{CB}=100\text{V}$			1	μA
Emitter Cut-Off Current	I_{EBO}	$V_{EB}=4\text{V}$			1	μA
DC Current Transfer Ratio	h_{FE}	$V_{CE}=5\text{V}, I_C=0.1\text{A}$	82		390	
Collector-Emitter Saturation Voltage	$V_{CE(SAT)}$	$I_C=I_B=1\text{A}/0.1\text{A}$ (Note)			0.4	V
Transition Frequency	f_T	$V_{CE}=5\text{V}, I_E=-0.1\text{A}, f=30\text{MHz}$.		80		MHz
Output Capacitance	C_{OB}	$V_{CB}=10\text{V}, I_E=0\text{A}, f=1\text{MHz}$ (Note)		20		pF

Note: Measured using pulse current.

■ CLASSIFICATION OF h_{FE}

RANK	P	Q	R
RANGE	82-180	120-270	180-390

■ TYPICAL CHARACTERISTICS

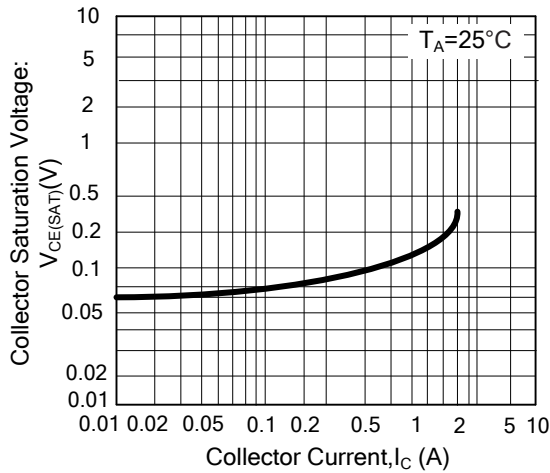
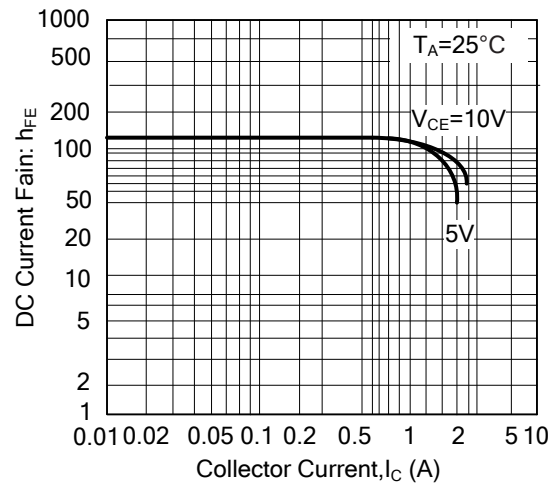
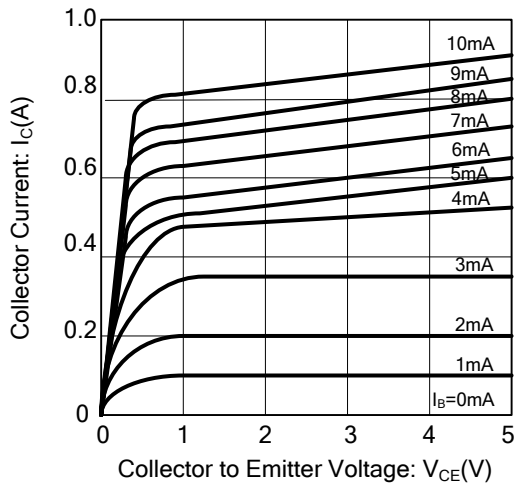

UTC assumes no responsibility for equipment failures that result from using products at values that exceed, even momentarily, rated values (such as maximum ratings, operating condition ranges, or other parameters) listed in products specifications of any and all UTC products described or contained herein. UTC products are not designed for use in life support appliances, devices or systems where malfunction of these products can be reasonably expected to result in personal injury. Reproduction in whole or in part is prohibited without the prior written consent of the copyright owner. The information presented in this document does not form part of any quotation or contract, is believed to be accurate and reliable and may be changed without notice.