

General Purpose Relay LY

- Arc barrier equipped.
- High dielectric strength (2,000 VAC).
- Long dependable service life assured by Ag-Alloy contacts.
- Choose models with single or bifurcated contacts, LED indicator, diode surge suppression, push-to-test button, or RC circuit.
- UL, CSA, and TUV approvals on all standard LY Relays.
- CE marks included on non-PCB mount versions.

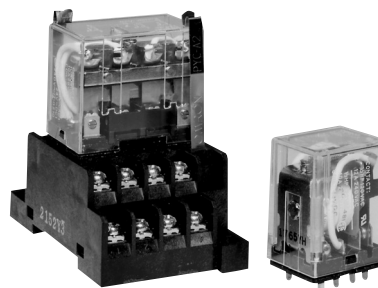

Ordering Information

To Order: Select the part number and add the desired coil voltage rating (e.g., LY1-DC6).

Type	Terminal	Contact form	Model			
			Single contact		Bifurcated contact	
			Standard bracket mounting	Upper mounting bracket	Standard bracket mounting	Upper mounting bracket
Standard	Plug-in/solder	SPDT	LY1	LY1F	—	—
		DPDT	LY2	LY2F	LY2Z	LY2ZF
		3PDT	LY3	LY3F	—	—
		4PDT	LY4	LY4F	—	—
	PCB	SPDT	LY1-0	—	—	—
		DPDT	LY2-0	—	LY2Z-0	—
		3PDT	LY3-0	—	—	—
		4PDT	LY4-0	—	—	—
LED indicator	Plug-in/solder	SPDT	LY1N	—	—	—
		DPDT	LY2N	—	LY2ZN	—
		3PDT	LY3N	—	—	—
		4PDT	LY4N	—	—	—
Diode surge suppression	Plug-in/solder	SPDT	LY1-D	—	—	—
		DPDT	LY2-D	—	LY2Z-D	—
		3PDT	LY3-D	—	—	—
		4PDT	LY4-D	—	—	—
LED indicator and diode surge suppression	Plug-in/solder	SPDT	LY1N-D2	—	—	—
		DPDT	LY2N-D2	—	LY2ZN-D2	—
		4PDT	LY4N-D2	—	—	—
RC circuit	Plug-in/solder	SPDT	LY1-CR	—	—	—
		DPDT	LY2-CR	—	LY2Z-CR	—
LED indicator and RC circuit	Plug-in/solder	SPDT	LY1N-CR	—	—	—
		DPDT	LY2N-CR	—	LY2ZN-CR	—

- Note:**
1. Types with specifications other than those listed are available. Contact your Omron Sales representative.
 2. To order connecting sockets and mounting tracks, see "Accessories" section.
 3. Relays with RC circuit are only available in AC coil voltages of 100 VAC or greater.

Type	Terminal	Contact form	Model			
			Single contact		Bifurcated contact	
			Standard bracket mounting	Upper mounting bracket	Standard bracket mounting	Upper mounting bracket
Push-to-test button	Plug-in/solder	SPDT	LY114	—	—	—
		DPDT	LY214	—	LY2ZI2	—
		3PDT	LY314	—	—	—
		4PDT	LY414	—	—	—
LED indicator and push-to-test button	Plug-in/solder	DPDT	LY214N	—	LY2ZI2N	—
		4PDT	LY414N	—	—	—

Note: 1. Types with specifications other than those listed are available. Contact your Omron Sales representative.
 2. To order connecting sockets and mounting tracks, see “Accessories” section.

■ Accessories

Connecting Sockets

To Order: Select the appropriate part numbers for sockets, clips, and mounting tracks (if required) from the following charts.

Track Mounted Sockets

Relay	Socket*	Relay hold-down clip		Mounting track
		Standard	RC circuit	
SPDT DPDT	PTF08A-E	PYC-A1	Y92H-3	PFP-100N/PFP-50N & PFP-M or PFP-100N2 PFP-S (Option spacer)
3PDT	PTF11A			
4PDT	PTF14A-E			

* Track mounted socket can be used as a front connecting socket.

Back Connecting Sockets

Relay	Solder terminal socket	Wire wrap terminal socket	Relay hold-down clip				Socket Mounting Plate			
			Standard	Push-to-test	RC circuit	Mtg. plate	1	10	12	18
SPDT DPDT	PT08	PT08QN	PYC-P	PYC-P2	PYC-1	PYC-S	PYP-1	—	—	PYP-18
3PDT	PT11	PT11QN					PTP-1-3	—	PTP-12	—
4PDT	PT14	PT14QN					PTP-1	PTP-10	—	—

Note: Types PYP-18, PTP-12 and PTP-10 may be cut to any desired length.

Relay	PC terminal socket	Relay hold-down clip		
		Standard	Push-to-test	RC circuit
SPDT DPDT	PT08-0	PYC-P	PYC-P2	PYC-1
3PDT	PT11-0			
4PDT	PT14-0			

Specifications

■ Contact Data

Load	Single contact				Bifurcated contact	
	SPDT		DPDT, 3PDT, 4PDT		DPDT	
	Resistive load (p.f. = 1)	Inductive load (p.f. = 0.4) (L/R = 7 ms)	Resistive load (p.f. = 1)	Inductive load (p.f. = 0.4) (L/R = 7 ms)	Resistive load (p.f. = 1)	Inductive load (p.f. = 0.4) (L/R = 7 ms)
Rated load	15 A at 110 VAC 15 A at 24 VDC	10 A at 110 VAC 7 A at 24 VDC	10 A at 110 VAC 10 A at 24 VDC	7.5 A at 110 VAC 5 A at 24 VDC	5 A at 110 VAC 5 A at 24 VDC	4 A at 110 VAC 4 A at 24 VDC
Contact material	Ag-Alloy					
Carry current	15 A		10 A		7 A	
Max. operating voltage	250 VAC 125 VDC					
Max. operating current	15 A		10 A		7 A	
Max. switching capacity	1,700 VA 360 W	1,100 VA 170 W	1,100 VA 240 W	825 VA 120 W	550 VA 120 W	440 VA 100 W
Min. permissible load	100 mA, 5 VDC				10 mA, 5 VDC	

■ Coil Data

1- and 2-pole Types – AC

Rated voltage (V)	Rated current (mA)		Coil resistance (Ω)	Coil inductance (ref. value) (H)		Pick-up voltage	Dropout voltage	Maximum voltage	Power consumption (VA, W)
	50 Hz	60 Hz		Armature OFF	Armature ON				
6	214.10	183	12.20	0.04	0.08	80% max.	30% min.	110%	Approx. 1.00 to 1.20 (60 Hz)
12	106.50	91	46	0.17	0.33				
24	53.80	46	180	0.69	1.30				
50	25.70	22	788	3.22	5.66				
100/110	11.70/12.90	10/11	3,750	14.54	24.60				
110/120	9.90/10.80	8.40/9.20	4,430	19.20	32.10				
200/220	6.20/6.80	5.30/5.80	12,950	54.75	94.07				
220/240	4.80/5.30	4.20/4.60	18,790	83.50	136.40			Approx. 0.90 to 1.10 (60 Hz)	

1- and 2-pole Types – DC

Rated voltage (V)	Rated current (mA)	Coil resistance (Ω)	Coil inductance (ref. value) (H)		Pick-up voltage	Dropout voltage	Maximum voltage	Power consumption (VA, W)
			Armature OFF	Armature ON				
6	150	40	0.16	0.33	80% max.	10% min.	110%	Approx. 0.90
12	75	160	0.73	1.37				
24	36.90	650	3.20	5.72				
48	18.50	2,600	10.60	21				
100/110	9.10/10	11,000	45.60	86.20				

- Note:**
1. The rated current and coil resistance are measured at a coil temperature of 23°C (73°F) with tolerances of +15%, -20% for AC rated current, and ±15% for DC rated coil resistance.
 2. The AC coil resistance and inductance are reference values at 60 Hz.
 3. The performance characteristics are measured at a coil temperature of 23°C (73°F).
 4. Class B coil insulation is available.

3-pole Type – AC

Rated voltage (V)	Rated current (mA)		Coil resistance (Ω)	Coil inductance (ref. value) (H)		Pick-up voltage	Dropout voltage	Maximum voltage	Power consumption (VA, W)
	50 Hz	60 Hz		Armature OFF	Armature ON				
6	310	270	6.70	0.03	0.05	80% max.	30% min.	110%	Approx. 1.60 to 2.00 (60 Hz)
12	159	134	24	0.12	0.21				
24	80	67	100	0.44	0.79				
50	38	33	410	2.24	3.87				
100/110	15.90/18.30	13.60/15.60	2,300	10.50	18.50				
120	17.30	14.8	2,450	11.50	20.60				
200/220	10.50/11.60	9.00/9.90	8,650	34.80	59.50				
240	9.40	8	10,400	38.60	74.60				

3-pole Type – DC

Rated voltage (V)	Rated current (mA)	Coil resistance (Ω)	Coil inductance (ref. value) (H)		Pick-up voltage	Dropout voltage	Maximum voltage	Power consumption (VA, W)
			Armature OFF	Armature ON				
6	234	25.70	0.11	0.21	80% max.	10% min.	110%	Approx. 1.40
12	112	107	0.45	0.98				
24	58.60	410	1.89	3.87				
48	28.20	1,700	8.53	13.90				
100/110	12.70/13	8,500	29.60	54.30				

4-pole Type – AC

Rated voltage (V)	Rated current (mA)		Coil resistance (Ω)	Coil inductance (ref. value) (H)		Pick-up voltage	Dropout voltage	Maximum voltage	Power consumption (VA, W)
	50 Hz	60 Hz		Armature OFF	Armature ON				
6	386	330	5	0.02	0.04	80% max.	30% min.	110%	Approx. 1.95 to 2.50 (60 Hz)
12	199	170	20	0.10	0.17				
24	93.60	80	78	0.38	0.67				
50	46.80	40	350	1.74	2.88				
100/110	22.50/25.50	19/21.80	1,800	10.50	17.30				
120	19.00	16.40	2,200	9.30	19				
200/220	11.50/13.10	9.80/11.20	6,700	33.10	57.90				
240	11.00	9.50	9,000	33.20	63.40				

4-pole Type – DC

Rated voltage (V)	Rated current (mA)	Coil resistance (Ω)	Coil inductance (ref. value) (H)		Pick-up voltage	Dropout voltage	Maximum voltage	Power consumption (VA, W)
			Armature OFF	Armature ON				
6	240	25	0.09	0.21	80% max.	10% min.	110%	Approx. 1.50
12	120	100	0.39	0.84				
24	69	350	1.41	2.91				
48	30	1,600	6.39	13.60				
100/110	15/15.90	6,900	32	63.70				

- Note:**
1. The rated current and coil resistance are measured at a coil temperature of 23°C (73°F) with tolerances of +15%, -20% for AC rated current, and ±15% for DC rated coil resistance.
 2. The AC coil resistance and inductance are reference values at 60 Hz.
 3. The performance characteristics are measured at a coil temperature of 23°C (73°F).
 4. Class B coil insulation is available.

Characteristics

Contact resistance		50 mΩ max.
Operate time		25 ms max.
Release time		25 ms max.
Operating frequency	Mechanically	18,000 operations/hour
	Under rated load	1,800 operations/hour
Insulation resistance		100 MΩ min. (at 500 VDC)
Dielectric strength		2,000 VAC, 50/60 Hz for 1 minute 1,000 VAC, 50/60 Hz for 1 minute between contacts of same polarity
Vibration	Mechanical durability	10 to 55 Hz, 1.00 mm (0.04 in) double amplitude
	Malfunction durability	10 to 55 Hz, 1.00 mm (0.04 in) double amplitude
Shock	Mechanical durability	1,000 m/s ² (approx. 100 G)
	Malfunction durability	200 m/s ² (approx. 20 G)
Ambient temperature	Operating	LY1, LY2, LY3: -25° to 55°C; LY4 = -25° to 40°C
Humidity		35 to 85% RH
Service Life	Mechanically	AC: 50 million operations min. (at operating frequency of 18,000 operations/hour) DC: 100 million operations min. (at operating frequency of 18,000 operations/hour)
	Electrically	See "Characteristic Data"
Weight		SPDT, DPDT: Approx. 40 g (1.41 oz), 3PDT: Approx. 50 g (1.76 oz) 4PDT: Approx. 70 g (2.47 oz)

Note: Data shown are of initial value.

Characteristic Data

Maximum switching capacity

LY1

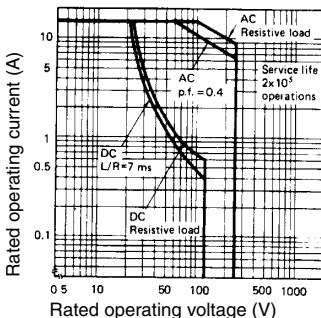

LY2

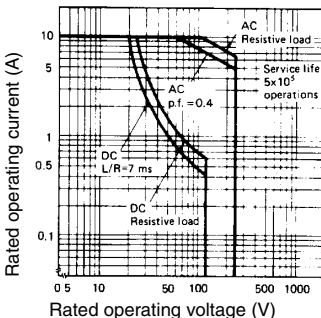

LY3, LY4

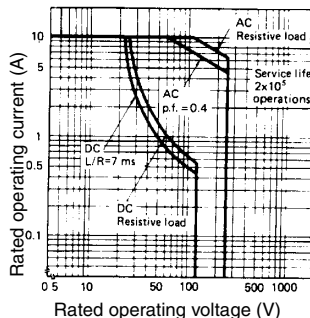

LY2Z

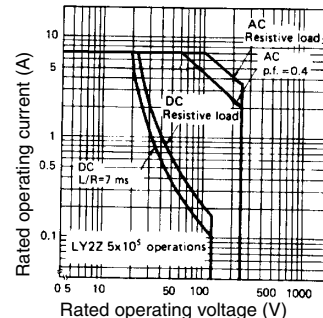

Electrical service life

LY1

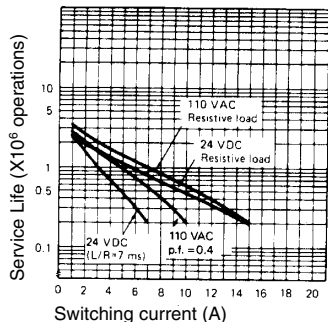

LY2

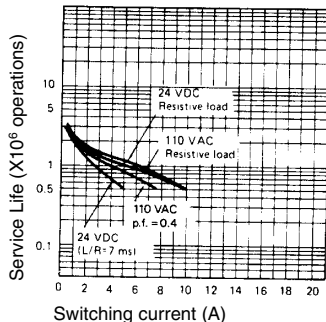

LY3, LY4

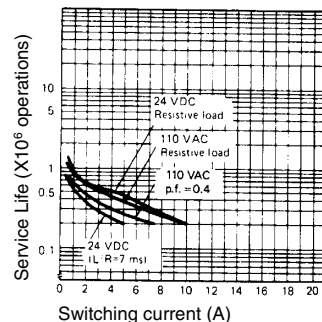

LY2Z

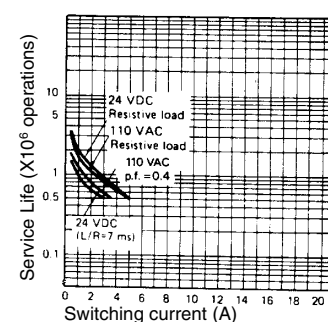

Dimensions

Unit: mm (inch)

Relays

LY1

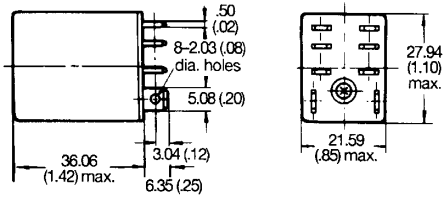

Terminal arrangement (Bottom view)

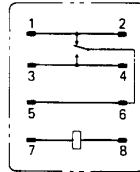

LY2

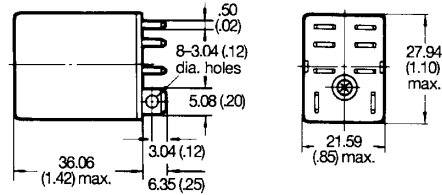

Terminal arrangement (Bottom view)

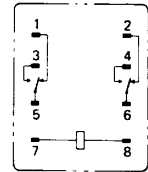

LY3

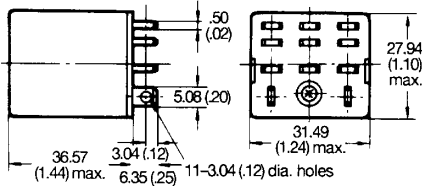

Terminal arrangement (Bottom view)

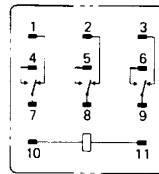

LY4

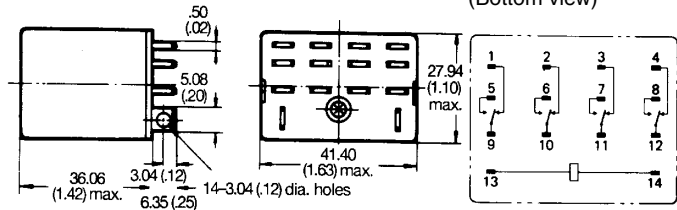

Terminal arrangement (Bottom view)

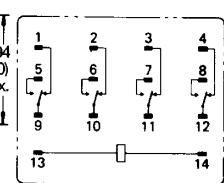

LY1-0, LY2-0, LY3-0, LY4-0

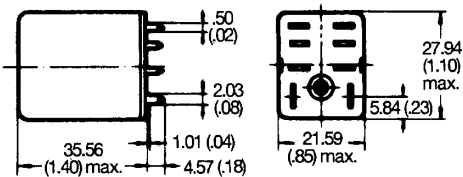

Note: The above drawing shows LY2-0. With LY1-0, dimension "*" should read as eight 6.35 (.25).

Mounting holes for LY1-0, LY2-0, LY3-0, LY4-0 (Bottom view)

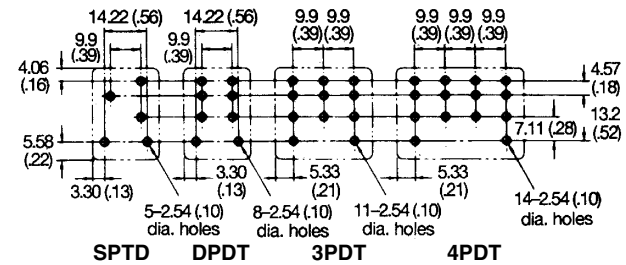

LY1F, LY2F

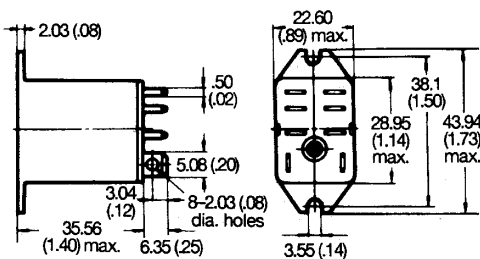

Mounting holes

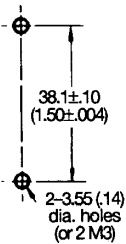

LY3F

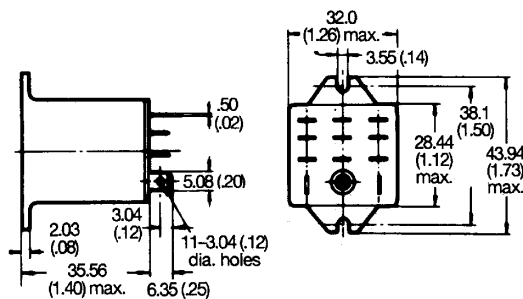

Mounting holes

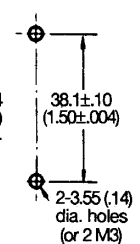

Note: The above drawing shows LY1F. With LY2F, dimension "*" should read as eight 3.05 mm (0.12 in) dia. holes.

LY4F

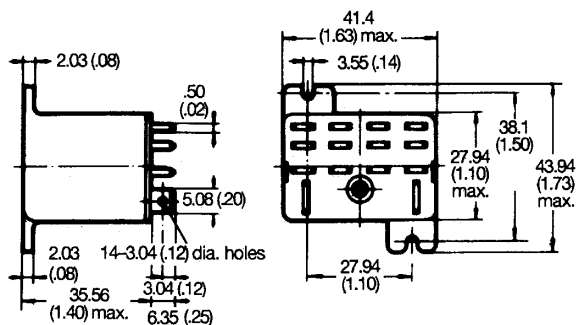

Mounting holes

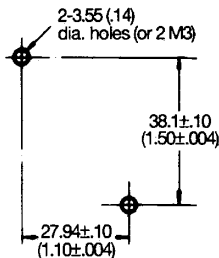

LY1S, LY2S

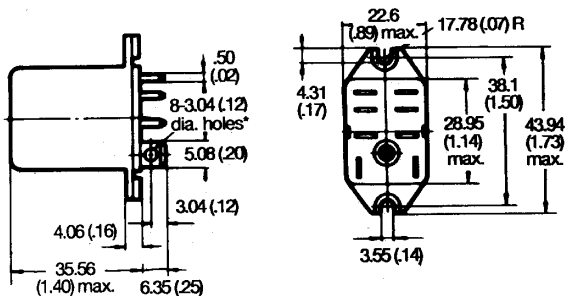

Round hole

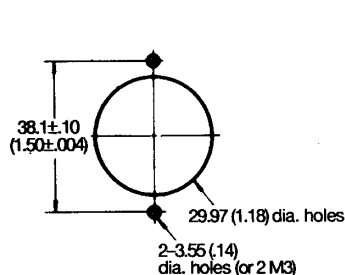

Rectangular hole

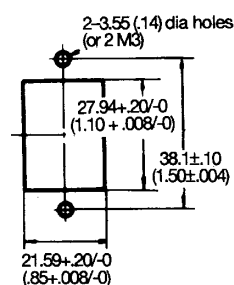

Note: The above drawing shows LY2S-US. With LY1S-US, dimension *** should read as eight 2.03 mm (0.08 in) dia. holes.

LY3S

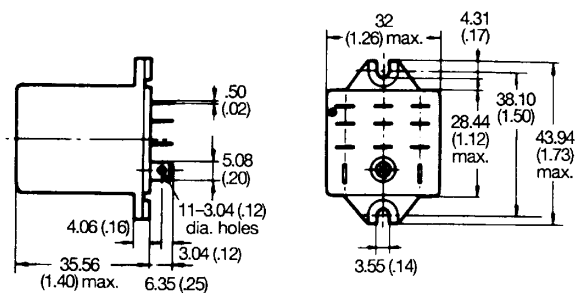

Round hole

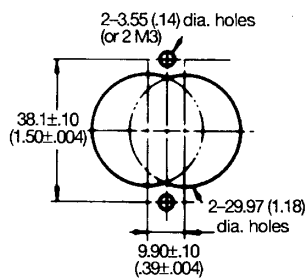

Rectangular hole

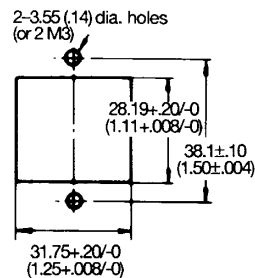

LY4S

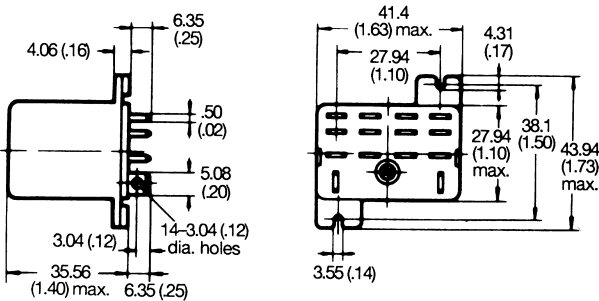

Round hole

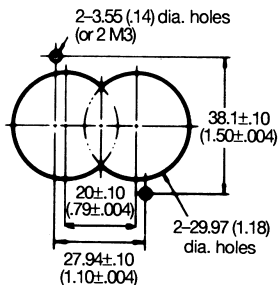

Rectangular hole

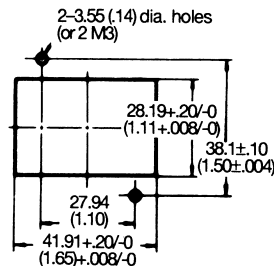

■ Accessories

Unit: mm (inch)

Track mounted sockets (UL File No. E87929) (CSA Report No. LR31928)

PTF08A
(see note 3)

**Terminal arrangement/
mounting holes**
(Top view)

PTF11A

**Terminal arrangement/
mounting holes**
(Top view)

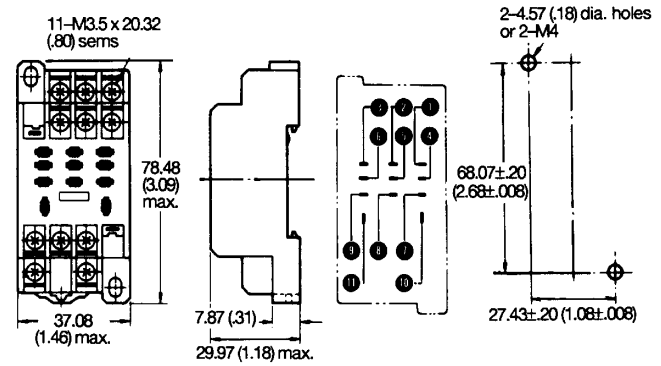
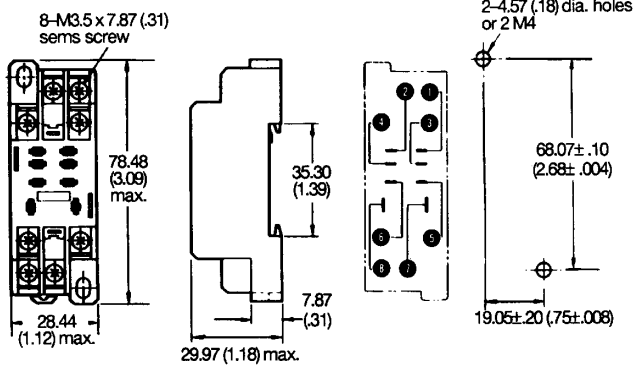

Track mounting sockets (UL File No. E87929) (CSA Report No. LR31928)

PTF14A
(see note 3)

**Terminal arrangement/
mounting holes**
(Top view)

**Mounting height of
relay with socket**
(Applies to all PTF□A sockets)

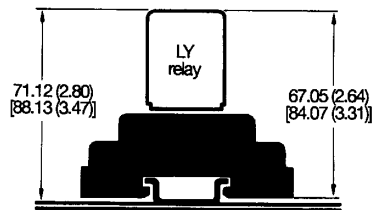
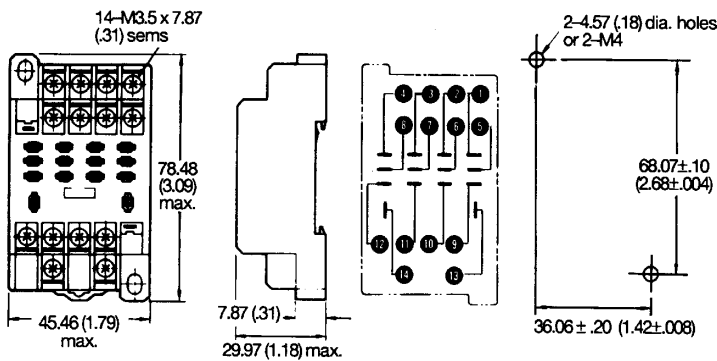

- Note:**
1. UL/CSA does not apply to wire wrap (Q) type sockets.
 2. Values in brackets for LY□CR.
 3. PTF08A-E and PTF14A-E = touch safe screws. Height = 33 mm max.

Back connecting socket (UL File No. E87929) (CSA Report No. LR31928)

PT08

**Terminal arrangement/
(Bottom view)**

PT11

**Terminal arrangement/
(Bottom view)**

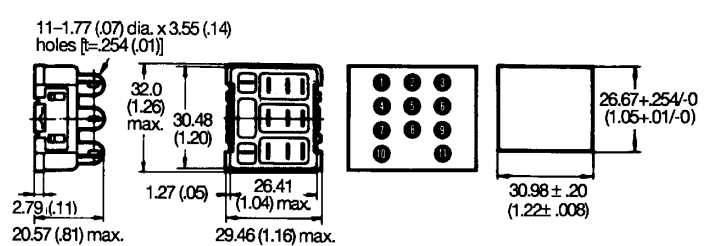
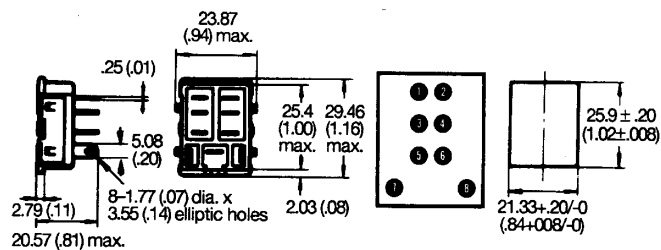

Back connecting socket (UL File No. E87929) (CSA Report No. LR31928)

PT14

Terminal arrangement
(Bottom view)

Mounting height of relay with socket
(Applies to all PT sockets)

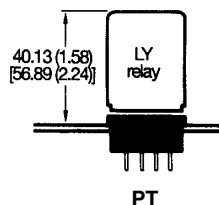
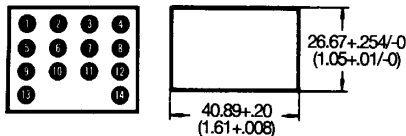
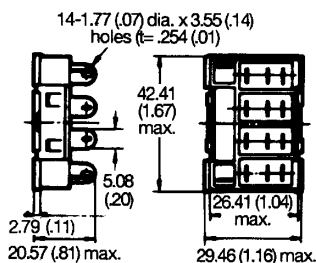

Note: Values in brackets for LY□CR.

Back connecting socket (UL File No. E87929) (CSA Report No. LR31928)

PT08QN

Panel cut-out and terminal arrangement are the same as Type PT08.

PT11QN

Panel cut-out and terminal arrangement are the same as Type PT11.

PT14QN

Panel cut-out and terminal arrangement are the same as Type PT14.

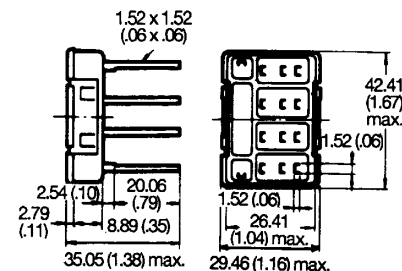
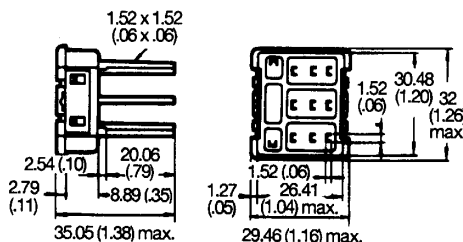
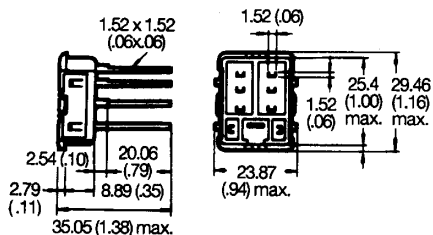

Back connecting socket (UL File No. E87929) (CSA Report No. LR31928)

PT08-0

Terminal arrangement is the same as Type PT08.

Mounting holes
(Bottom view)

PT11-0

Terminal arrangement is the same as Type PT11.

Mounting holes
(Bottom view)

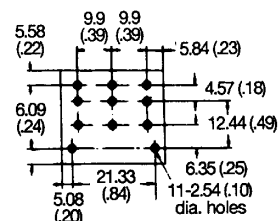
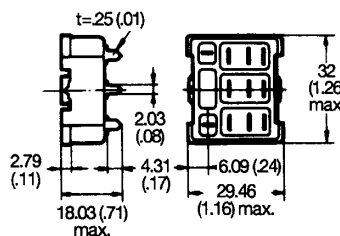
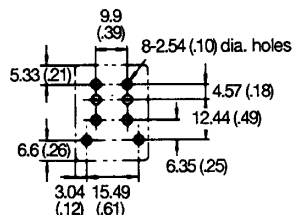
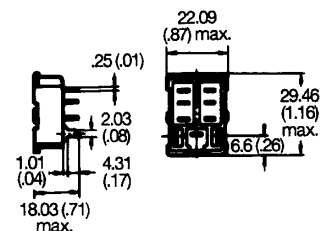

Back connecting socket (UL File No. E87929) (CSA Report No. LR31928)

PT14-0

Terminal arrangement is the same as Type PT14.

Mounting holes
(Bottom view)

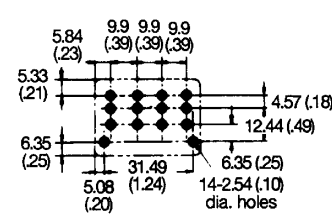
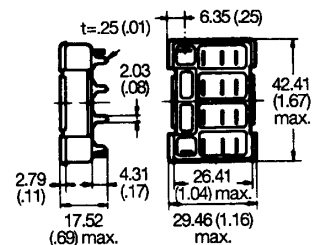

Unit: mm (inch)

Relay hold-down clips

PYC-A1

For PTF□A socket

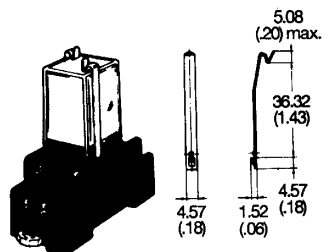

PYC-S

For relay mounting plates
(Applicable to Type PYP-1 and PYP-18 socket mounting plates only.)

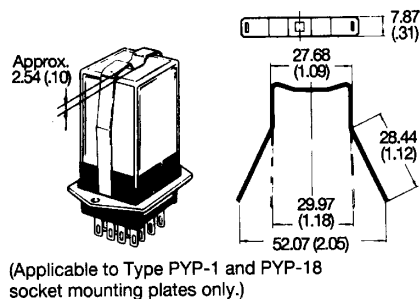

PYC-P

For PT□ socket

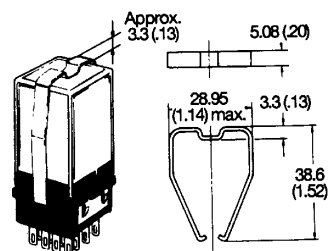

Relay hold-down clips

PYC-P2

For push-to-test button type with PT□ socket

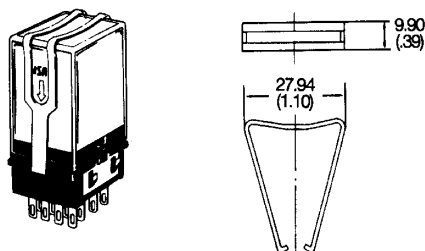

Y92H-3

For RC circuit type

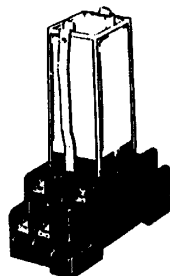

PYC-1

For RC circuit type



Mounting track/end plate/spacer

PFP-100N, PFP-50N
(Conforming to EN 50022)

PFP-100N2
(Conforming to EN 50022)

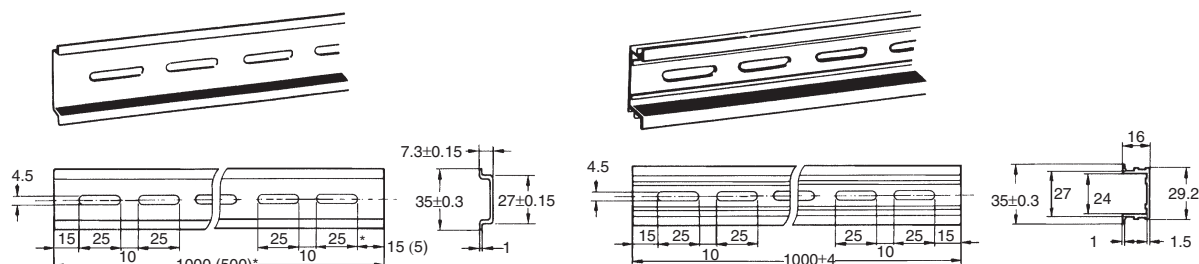

* The figure in parenthesis is for PFP-50N.

*This dimension is 14.99 mm (0.59 in) on both ends in the case of PFP-100N, but on one end in the case of PFP-50N.

** L = Length

PFP-50N L = 497.84 mm (19.60 in)

PFP-100N L = 990.60 mm (39.00 in)

PFP-100N2 L = 990.60 mm (39.00 in)

***A total of twelve 24.89 x 4.57 mm (0.98 x 0.18 in) elliptic holes are provided, with six holes cut from each end of the track at a pitch of 9.91 (0.39) between holes.

PFP-M end plate

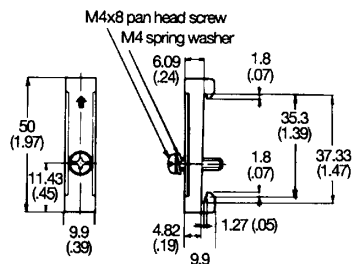

PFP-S spacer

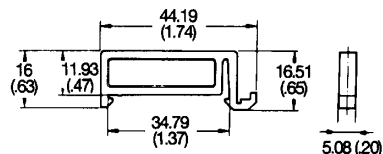

Socket mounting plates [t=1.52 (.06)]

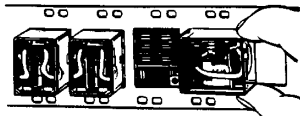

Socket needed	Number of socket specs.			
	1	10	12	18
PT08, PT08QN	PYP-1	-	-	PYP-18
PT11, PT11QN	PTP-1-3	-	PTP-1-2	-
PT14, PT14QN	PTP-1	PTP-10	-	-
PTP-10	PTP-12			

PYP-1

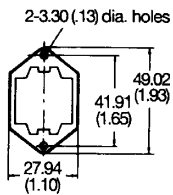

PTP-1-3

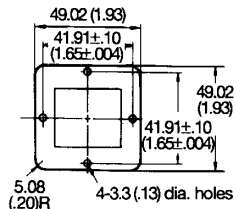

PTP-1

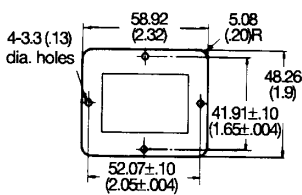

PYP-18

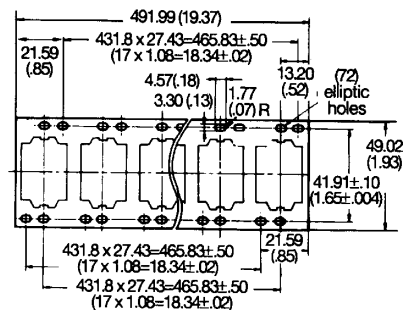

PTP-10

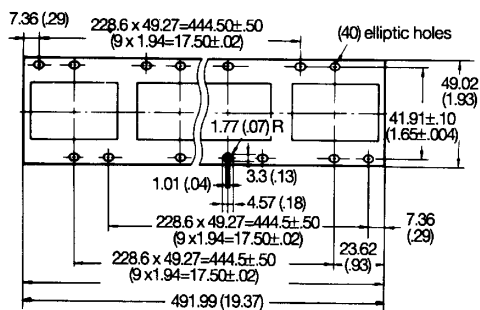

PTP-12

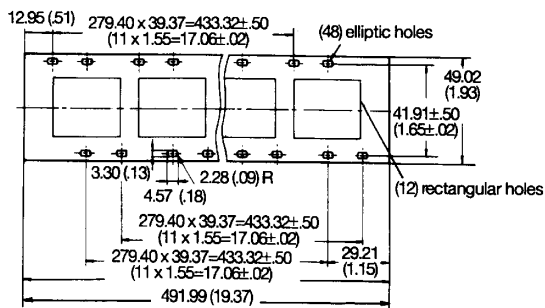

Relay Options

LED Indicator

Specifications and dimensions same as the Standard Type with the following exception. With the LED indicator type, the rated current is approximately 0 to 5.0 mA higher than the Standard Type.

Terminal arrangement/Internal connections (Bottom view)

LY2N

DC coil rating type

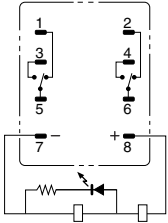

AC coil rating type

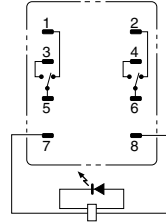

- Note:**
1. The coil terminals 10 and 11 of Type LY3N become (-) and (+) and terminals 13 and 14 of Type LY4N become (-) and (+), respectively.
 2. Pay special attention to the polarities when using the DC type.

Diode Surge Suppression

Specifications and dimensions same as the Standard Type with the following exception. Ambient operating temperature: -25° to 40°C (-13° to 104°F)

Without Diode

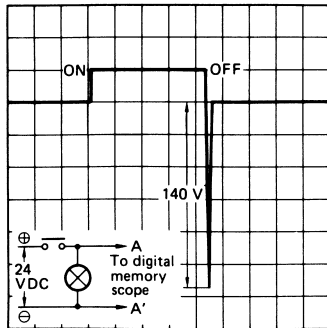

With Diode

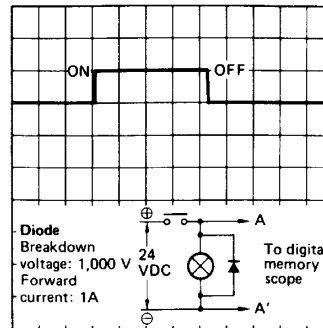

Terminal arrangement/Internal connections (Bottom view)

LY2(N)-D(2)

LY2-D
6, 12, 24, 48
100/110 VDC

LY2N-D2
6, 12, 24, 48 VDC

LY2N-D2
100/110 VDC

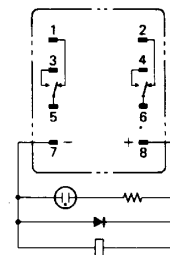
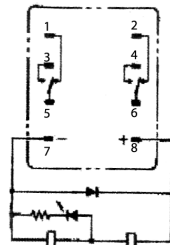
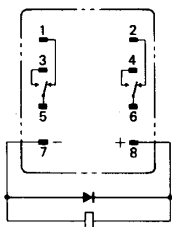

- Note:**
1. Pay special attention to the polarities when using the DC type.
 2. The release time is somewhat longer, but satisfies the standard specifications of 25 ms.
 3. The reverse-breakdown voltage of the diode is 1,000 VDC.
 4. Available on DC versions only.

Relay Options

RC Circuit

Specifications and dimensions same as the Standard Type with the following exceptions.

Characteristic Data

Without RC circuit

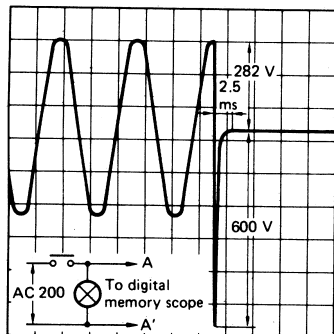

With RC circuit

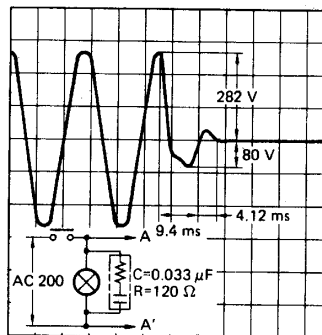

LY1-CR, LY2(Z)-CR

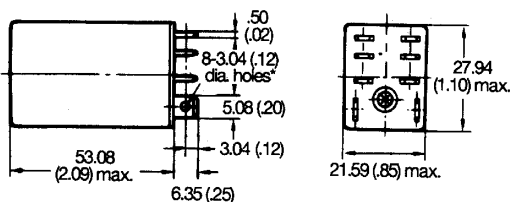

Terminal arrangement/Internal connections (Bottom view)

LY1-CR

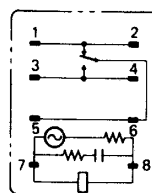

LY2(Z)-CR

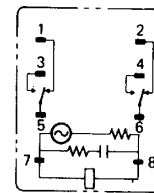

RC circuit
C: 0.033 μF
R: 120 Ω

Note: 1. The above drawing shows LY2(Z)-CR. With LY1-CR, “**” should read eight 2.03 mm (0.08 in) dia. holes.
2. Available on AC versions only.

Push-to-test Button

Specifications and dimensions same as the Standard Type with the following exceptions.

LY□12

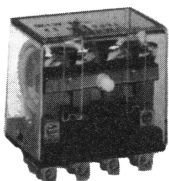

LY112, LY212

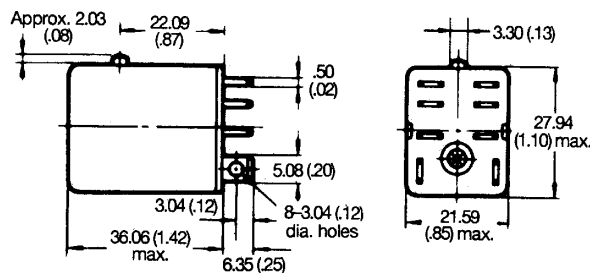

Note: Type LY112 has the same dimensions and appearances as Type LY212 shown except that dimensions “**” is 2.03 mm (0.08 in) dia. holes.

LY312

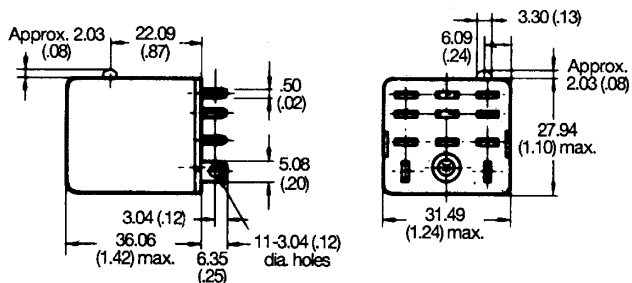

LY412

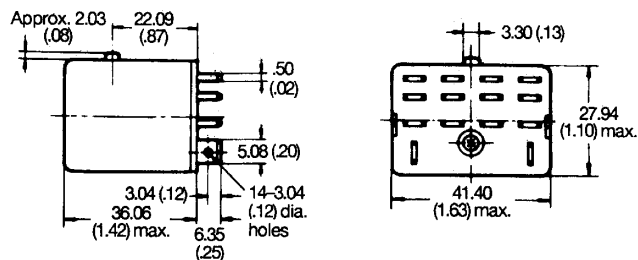

■ Approvals

UL Recognized Type (File No. E41643)

Type	Contact form	Coil ratings	Contact ratings	Number of test operations
LY1□	SPDT	6 to 240 VAC 6 to 120 VDC	15A, 30VDC (Resistive), 40°C	6 x 10 ³
			15A, 240VAC (General use), 40°C	
			TV-5, 120VAC, 40°C	25 x 10 ³
			1/2HP, 120VAC, 50°C	
LY2□	DPDT		15A, 28VDC (Resistive), 40°C	6 x 10 ³
			15A, 120VAC (Resistive), 40°C	
			12A, 240VAC (General use), 40°C	25 x 10 ³
			1/2HP, 120VAC, 50°C	
	TV-3, 120VAC, 40°C			
LY3□	3PDT		10A, 30VDC (Resistive), 40°C (Same polarity)	6 x 10 ³
LY4□	4PDT		10A, 240VAC (General use), 40°C (Same polarity)	
			1/2HP, 240VAC, 40°C	
LY2Z□ (Bifurcated)	DPDT		7A, 240VAC (General use), 40°C	6 x 10 ³
			7A, 28VDC (Resistive), 40°C	

CSA Certified Type (File No. LR31928)

Type	Contact form	Coil ratings	Contact ratings
LY1□	SPDT	6 to 240 VAC 6 to 120 VDC	15 A, 120 VAC (Inductive)
			10 A, 240 VAC (Inductive)
			15 A, 28 VDC (Resistive)
			TV-5 (ACTV)
LY2□	DPDT		13 A, 28 VDC (Resistive)
			12 A, 120 VAC (Inductive)
			10 A, 240 VAC (Inductive)
			1/3 HP, 120 VAC (Motor)
			TV-3 (ACTV)
LY3□	3PDT		10 A, 240 VAC (Inductive)
LY3□	4PDT		10 A, 28 VDC (Resistive)

VDE Approved Type (File No. 9903 [SPDT, DPDT & 3PDT], File No. 9947 [4PDT])

Type	Contact form	Coil ratings	Contact ratings
LY□-VD	SPDT	6, 12, 24, 50, 110, 220 VAC and 6, 12, 24, 48, 110 VDC	10 A, 220 VAC (Resistive)
			10 A, 28 VDC (Resistive)
			7 A, 220 VAC (Inductive)
			7 A, 28 VDC (Inductive)
LY□-VD	DPDT		7 A, 220 VAC (Resistive)
			7 A, 28 VDC (Resistive)
			4 A, 28 VDC and 4A, 220 VAC (Inductive)
	3PDT		
	4PDT		

LR (Lloyd's Register) Approved Type (File No. 562KOB-204523)

Type	Contact form	Coil ratings	Contact ratings
LY□	DPDT	6 to 240 VAC	7.5 A, 230 VAC (Inductive)
	4PDT	6 to 110 VDC	5 A, 24 VDC (Inductive)

SEV Listed Type (File No. D7 91/82 [2- & 4-pole], D 91/204a [1- & 3-pole])

Type	Contact form	Coil ratings	Contact ratings
LY□-SV	SPDT	6 to 240 VAC 6 to 110 VDC	15 A, 220 VAC (Resistive)
			15 A, 24 VDC (Resistive)
LY□-SV	DPDT		10 A, 220 VAC (Resistive)
	3PDT		10 A, 24 VDC (Resistive)
	4PDT		

- Note:**
1. The rated values approved by each of the safety standards (e.g., UL, CSA, VDE, and SEV) may be different from the performance characteristics individually defined in this catalog.
 2. In the interest of product improvement, specifications are subject to change.

A large grid of 20 columns and 30 rows of small squares, intended for taking notes or drawing diagrams. The grid is composed of thin, light gray lines forming a uniform pattern of small squares across the page.

All sales are subject to Omron Electronic Components LLC standard terms and conditions of sale, which can be found at http://www.components.omron.com/components/web/webfiles.nsf/sales_terms.html

ALL DIMENSIONS SHOWN ARE IN MILLIMETERS.

To convert millimeters into inches, multiply by 0.03937. To convert grams into ounces, multiply by 0.03527.

OMRON[®]

**OMRON ELECTRONIC
COMPONENTS LLC**

55 E. Commerce Drive, Suite B
Schaumburg, IL 60173

847-882-2288

OMRON ON-LINE

Global - <http://www.omron.com>

USA - <http://www.components.omron.com>

Cat. No. X301-E-1b

09/11

Specifications subject to change without notice

Printed in USA

Mouser Electronics

Authorized Distributor

Click to View Pricing, Inventory, Delivery & Lifecycle Information:

Omron:

[LYQ2-DC12](#) [LYQ2-0 DC24](#) [LYQ2-0-DC12](#) [PYP-1](#) [LYQ2 DC24](#) [LYQ2 DC6](#) [PYC-A1-6017](#)