

Low Profile "Swing-Lock" Board to Wire Connector for Power

DF57 Series

(Compliant with UL-CSA standards)

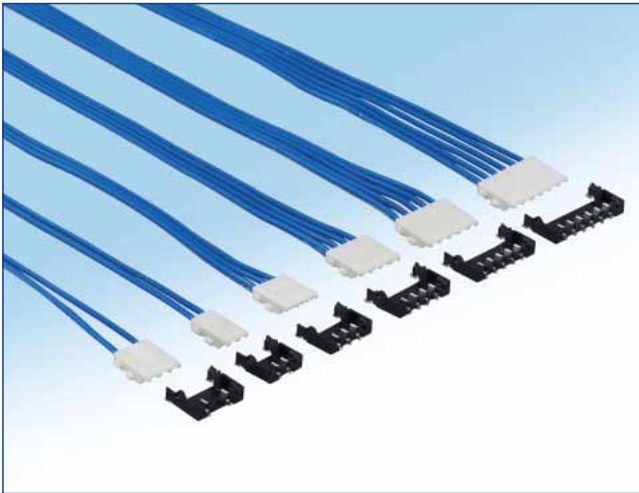

■ Features

1. Reinforced lock structure with swing lock

A swing-lock structure, featuring our own unique connection method, reinforces the lock structure of the electric cable side, with a structure resistant to tough electric cable routing and disengagement of cables under load.

In addition, the connection surface has a guide insertion to facilitate insertability (patented)

2. Header lock improves plug retention

When connecting, the header connector secures the molded-lance. Play of molded lance is prevented for added strength. (patented)

3. Highly reliable contact structure

Despite the low-profile design, with a stacking height of 1.4mm, an effective mating length of 0.42mm is achieved. The structure features two-point contact terminal geometry with high contact reliability.

4. Insert guide key prevents misalignment

Insert guide key guides the crimp socket to the correct mating position and prevents misalignment, which improves mating operation and prevents possible connector breakage with incorrect mating.

5. Solder wicking prevention

The integral molding eliminates any gap between the terminals and case to prevent solder wicking.

6. Case disengagement prevention

Reinforcing hardware (metal fittings) are integrated in the molding, which help prevent the case from disengaging with the terminals due to tough electric cable routing and load.

7. Cost effective

Terminals and metal fittings are collectively integrated into the molding to reduce assembly cost.

Swing-Lock Structure explanatory drawing

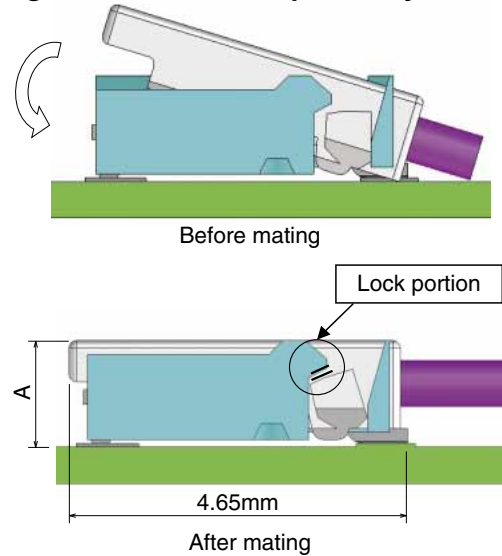

Mating Height A : DF57H 1.4mm
DF57AH 1.6mm

Fig.1

Contact Structure

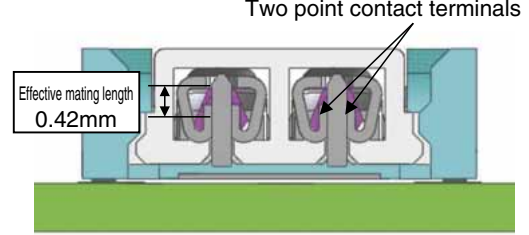

Cross-sectional view of the contact surface

Fig.2

Incorrect Positioning

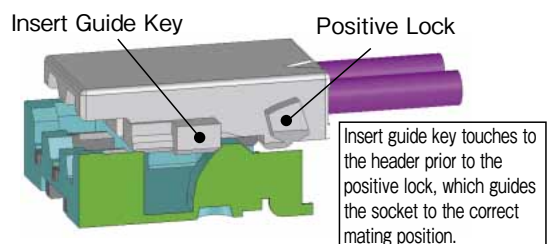

Starts mating after the socket is aligned to the correct position

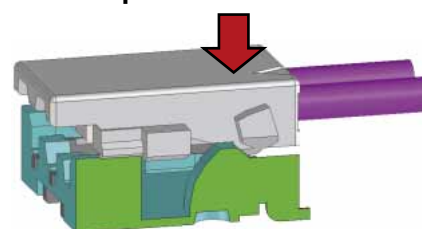

Insert Guide Key Structure

Fig.3

Specifications

Rating	Current rating		2pos.	3pos.	4pos.	5,6pos.	Operating temperature range -35°C to 85°C (Note 1) Operating humidity range 20% to 80%
		AWG#26	—	—	—	1.5A	
		AWG#28	2.5A	2.0A	1.5A		
		AWG#30	1.5A		1.0A		
		AWG#32	1.0A		0.8A		
	AWG#34	0.8A		0.5A			
Voltage rating	2 to 6 pos. :50V AC/DC 2 pos. (Middle pin of 3 pos. is removed): 100V AC/DC					Storage temperature range -10°C to 60°C (Note 2) Storage humidity range 40% to 70% (Note 2)	

UL-CSA certified specifications							
Rating	Current rating		2pos.	3pos.	4pos.	5,6pos.	
		AWG#26	—	—	—	1.5A	
		AWG#28	2.5A	2.0A	1.5A		
		AWG#30	1.5A		1.0A		
		AWG#32	1.0A		0.8A		
	AWG#34	0.8A		0.5A			
Voltage rating	2 - 6 pos. :29V AC/DC						

Item	Specification	Conditions
1. Insulation resistance	100 MΩ min.	100 V DC
2. Withstanding voltage	No flashover or insulation breakdown	500 V AC / 1 minute
3. Contact resistance	10 mΩ max.	20 mV max., at 1 mA.
4. Vibration	No electrical discontinuity of 1 μs or longer No damage, cracks or parts dislocation.	Frequency: 10 to 55 Hz, single amplitude of 0.75 mm, 10 cycles, 3 direction
5. Shock	No electrical discontinuity of 1 μs or longer No damage, cracks or parts dislocation.	Acceleration of 490 m/s ² , 11 ms duration, sine half-wave, 3 cycles in each of the 3 axis
6. Humidity	Contact resistance: 20 mΩ max., Insulation resistance: 500 MΩ min. No damage, cracks or parts dislocation.	96 hours at 40 ±2°C, and humidity of 90 to 95%
7. Temperature cycle	Contact resistance: 20 mΩ max., Insulation resistance: 500 MΩ min. No damage, cracks or parts dislocation.	-55°C → 5 to 35°C → 85°C → 5 to 35°C Times: 30 min. → 2 min. to 3 min. → 30 min. → 2 min. to 3 min. 5 cycles
8. Durability	Contact resistance: 20 mΩ max., No damage, cracks or parts dislocation.	30 cycles
9. Resistance to soldering heat	No deformation of components affecting performance	Reflow: At the recommended temperature profile Manual soldering: 350°C for 3 seconds

Note 1. Includes temperature rise caused by current flow.

Note 2. The term "storage" refers to products stored for a long period prior to mounting and use.

The operating temperature and humidity range covers the non-conducting condition of installed connectors in storage, shipment or during transportation.

Material

Product	Part	Material	Finish	Remarks
Header	Insulator	LCP	Color:Black	UL94V-0
	Contacts	Brass	Tin Plated	—
Crimp socket	Insulator	DF57H	PBT	White
			LCP	Black
		DF57AH	PBT	White
Crimp contacts	Contacts	Phosphor bronze	Tin Plated	—

Ordering information

Refer to the below information to identify the specifications of the product by its part No.

Header

DF **57** **H** - ***** **P** - **1.2** **V**

① ② ③ ④ ⑤ ⑥ ⑦

① Series name : DF	⑤ Connector type P : Plug
② Series No. : 57	⑥ Contact pitch : 1.2mm
③ Insert guide key H : Yes	⑦ Termination section V : Straight SMT
④ Number of contacts : 2, 3, 4, 5, 6	

DF **57** **H** - **2** **P** - **2.4** **V**

④ ⑥

④ Number of contacts : 2	⑥ Contact pitch : 2.4mm (Middle pin of 3 pos. is removed, and rated voltage is 100 V)
--------------------------	--

Socket

DF **57** **—** **H** - ***** **S** - **1.2** **C**

① ② ③ ④ ⑤ ⑥ ⑦ ⑧

① Series name : DF	⑤ Number of contacts : 2, 3, 4, 5, 6
② Series No. : 57	⑥ Connector type S : Crimp socket
③ Applicable wire size: Blank : AWG#28 to AWG#34	⑦ Contact pitch : 1.2mm
④ Insert guide key H : Yes	⑧ Termination section C : Crimp socket

DF **57** **A** **H** - ***** **S** - **1.2** **C**

③ ⑤

③ Applicable wire size: A : AWG#26 to AWG#34	⑤ Number of contacts : 5, 6
---	-----------------------------

Crimp contact

DF **57** - **2830** **SCF**

① ②

① Applicable wire size: 2628 : AWG#26 to AWG#28 2830 : AWG#28 to AWG#30 3234 : AWG#32 to AWG#34	② Packaging SCF : SCF: Female crimp contact / reel
--	---

Header(SMT)



Recommended PCB layout (Thickness: 1.0mm)

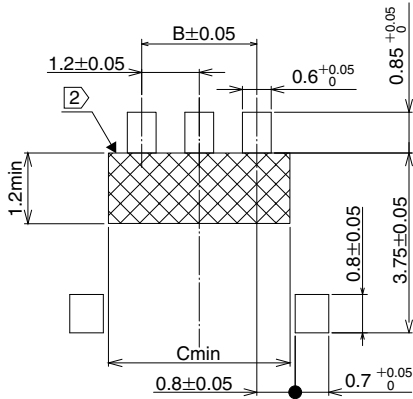

Recommended PCB layout (Thickness: 1.0mm)

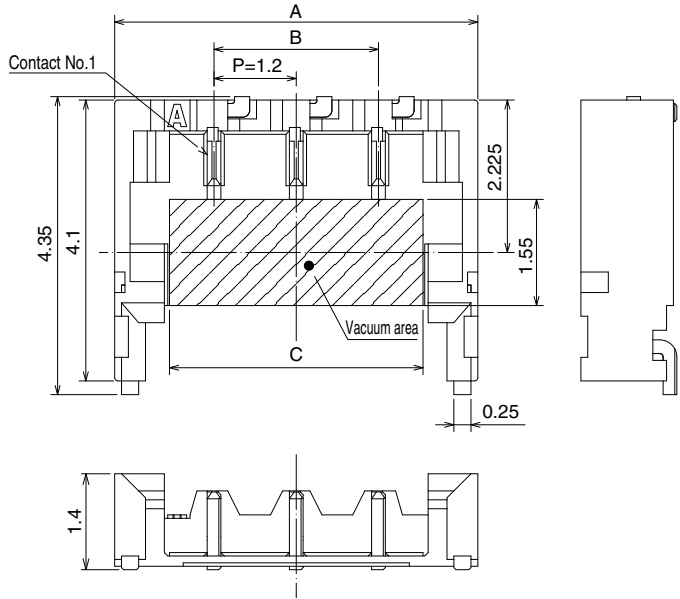
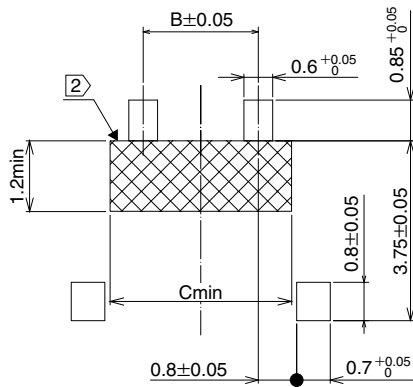

[Specification number]
(21): Tin plated, Embossed tape packaging (5,000 pcs/reel)

Unit : mm

Part No.	HRS No.	No. of contacts	A	B	C
DF57H-2P-1.2V(21)	666-0104-7 21	2	4.1	1.2	2.5
DF57H-3P-1.2V(21)	666-0105-0 21	3	5.3	2.4	3.7
DF57H-4P-1.2V(21)	666-0106-2 21	4	6.5	3.6	4.9
DF57H-5P-1.2V(21)	666-0107-5 21	5	7.7	4.8	6.1
DF57H-6P-1.2V(21)	666-0108-8 21	6	8.9	6.0	7.3

Note 1 : Embossed tape reel packaging (5,000 pcs/reel).

Note 2: The crossed-shaded area is a no conductive trace area.

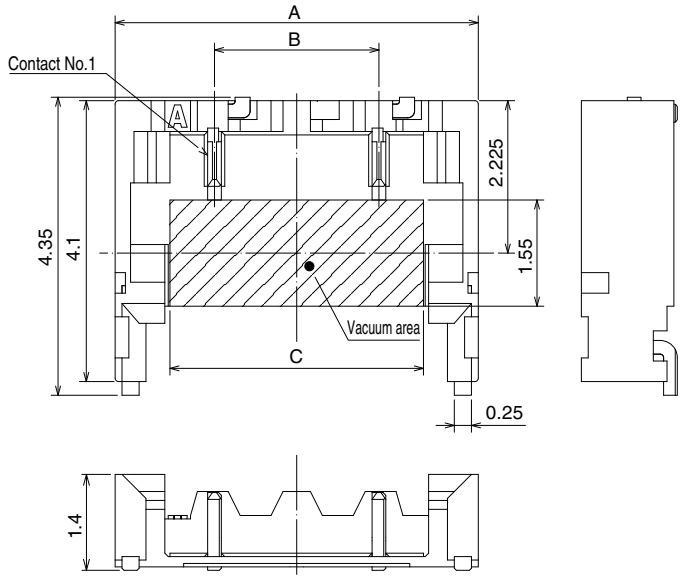

[Specification number]
(21): Tin plated, Embossed tape packaging (5,000 pcs/reel)

Unit : mm

Part No.	HRS No.	No. of contacts	A	B	C
DF57H-2P-2.4V(21)	666-0109-0 21	2	5.3	2.4	3.7

●Packaging Specification

DF57H-2P-1.2V(21)
DF57H-3P-1.2V(21)
DF57H-2P-2.4V(21)

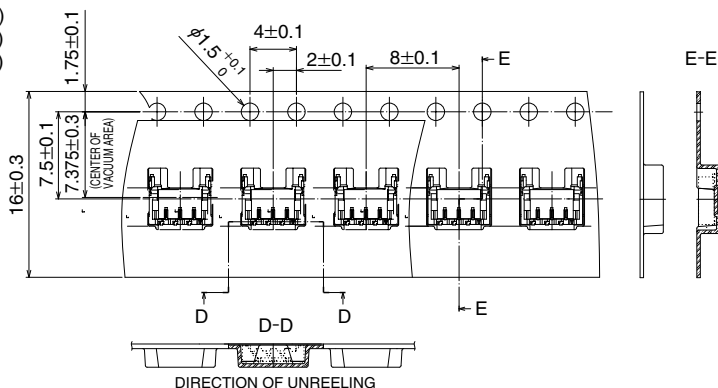

DF57H-4P-1.2V(21)
DF57H-5P-1.2V(21)
DF57H-6P-1.2V(21)

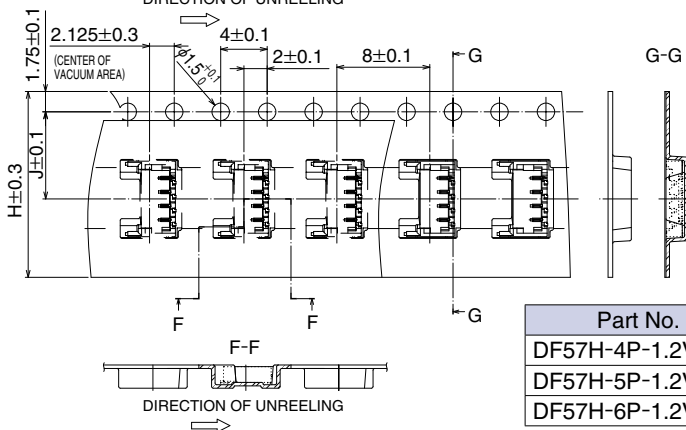

Unit : mm

Part No.	No. of contacts	H	J
DF57H-4P-1.2V(21)	4	16	7.5
DF57H-5P-1.2V(21)	5	16	7.5
DF57H-6P-1.2V(21)	6	24	11.5

■Crimp socket

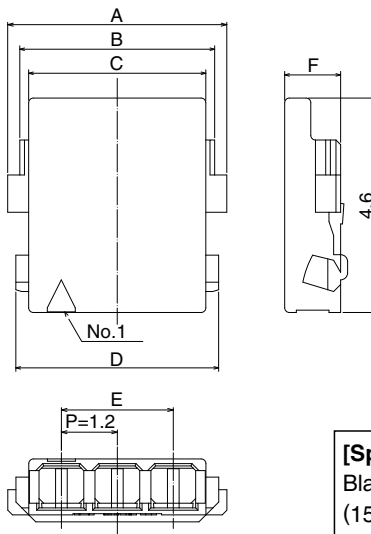
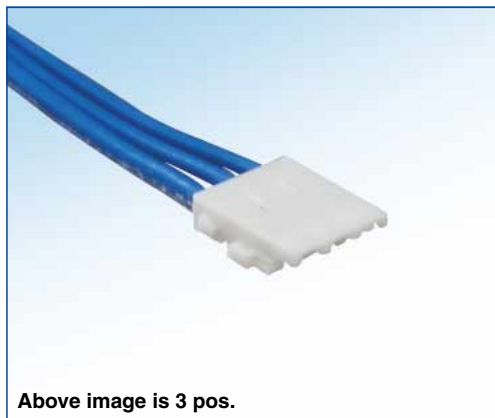

[Specification number](**),**
Blank: Color: White, 1,000 pcs/pack
(15): Color: Black, 1,000 pcs/pack

Unit : mm

Part No.	HRS No.	No. of contacts	A	B	C	D	E	F
DF57H-2S-1.2C(**)	666-0100-6 **	2	3.5	2.98	2.6	3.2	1.2	1.2
DF57H-3S-1.2C(**)	666-0012-0 **	3	4.7	4.18	3.8	4.4	2.4	1.2
DF57H-4S-1.2C(**)	666-0101-9 **	4	5.9	5.38	5.0	5.6	3.6	1.2
DF57H-5S-1.2C(**)	666-0102-1 **	5	7.1	6.58	6.2	6.8	4.8	1.2
DF57H-6S-1.2C(**)	666-0103-4 **	6	8.3	7.78	7.4	8.0	6.0	1.2

Note 1.The quantity is delivered per pack (1,000 pcs.). Order by number of pack.

■Socket for AWG#26

Unit : mm

Part No.	HRS No.	No. of contacts	A	B	C	D	E	F	Color
DF57AH-5S-1.2C	666-0110-0 00	5	7.1	6.58	6.2	6.8	4.8	1.4	Black
DF57AH-6S-1.2C	666-0111-2 00	6	8.3	7.78	7.4	8.0	6.0	1.4	

Note 1.The quantity is delivered per pack (1,000 pcs.). Order by number of pack.

■ Crimp contact

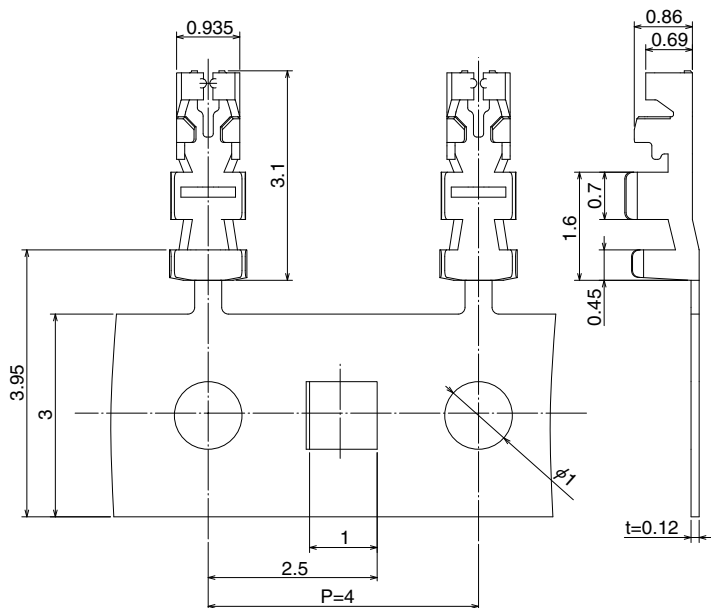

[Packaging Specification]
 Blank: Embossed tape packaging (40,000 pcs/reel)
 (41) : Embossed tape packaging (35,000 pcs/reel)

Part No.	HRS No.	Packaging	Quantity	Finish	Applicable wire	Applicable socket connector
DF57-2628SCF(41)	666-0013-3 41	Reel	35,000	Tin plated	AWG#26 – AWG#28	DF57AH-*S-1.2C
DF57-2830SCF	666-0001-4 00		40,000		AWG#28 – AWG#30	DF57H-*S-1.2C
DF57-3234SCF	666-0016-1 00				AWG#32 – AWG#34	DF57AH-*S-1.2C

Note: Embossed tape reel packaging (40,000 pcs/reel).
 Order by number of reels.

● Applicable wire (Tin plated annealed copper wire)

Part No.	Wire size (Stranded wire conductor)	Jacket outer diameter	Recommended cable
DF57-2628SCF(41)	AWG#26 (7/φ0.16mm)	φ0.88mm max.	UL3302, UL3610
	AWG#28 (7/φ0.127mm)		—————
DF57-2830SCF	AWG#28 (7/φ0.127mm)	φ0.5mm	UL1571 (Thin wire), UL10584 (ETFE wire)
	AWG#30 (7/φ0.102mm)	– φ0.63mm	
DF57-3234SCF	AWG#32 (7/φ0.08mm)	φ0.32mm	—————
	AWG#34 (7/φ0.08mm)	– φ0.42mm	

● Strip length 1.0 to 1.4mm

Note: When using other than the recommended wire, contact your nearest Hirose sales representative.

◆ Tools

Type	Part No.	HRS No.	Applicable contact
Applicator	AP105-DF57-2628S	901-4622-2 00	DF57-2628SCF
	AP105-DF57-2830S	901-4618-5 00	DF57-2830SCF
	AP105-DF57-3234S	901-4629-1 00	DF57-3234SCF
Press	CM-105	901-0005-4 00	—————
Hand crimping tool	HT305/DF57-2830HC	902-4635-0 00	DF57-2830SCF
Contact extraction tool	DF-C-PO(B)	550-0179-2 00	DF57-***SCF

Note: If any trouble has occurred due to tools other than the designated tool, Hirose bears no responsibility for any trouble.

◆ Usage Recommendations

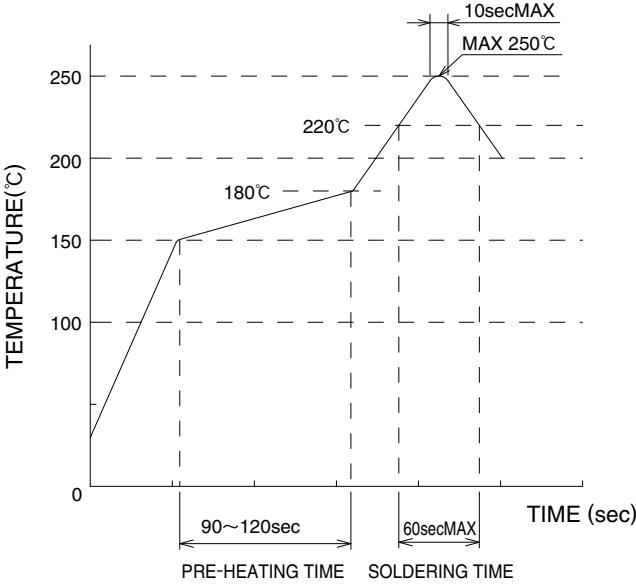
<p>1.Recommended temperature profile</p>	 <p>The temperature profiles are based on the above conditions. In individual applications the actual temperature may vary, depending on solder paste type, volume/thickness and board size/thickness. Consult your solder paste and equipment manufacturer for specific recommendations.</p>
<p>2.Recommended manual soldering</p>	<p>Manual soldering: 350°C ± 10°C for 3 seconds</p>
<p>3.Recommended screen thickness and open area ratio (Pattern area ratio)</p>	<p>Thickness: 0.1 mm Open area ratio: 100%</p>
<p>4.Board warpage</p>	<p>Maximum of 0.02mm at the connector center, with both ends of the connector as reference points.</p>
<p>5.Cleaning conditions</p>	<p>Cleaning is not recommended. When cleaning, please evaluate as if can deteriorate the performance including mechanical operation and environmental resistance.</p>
<p>6.Precautions</p>	<ul style="list-style-type: none"> ■When inserting crimp-type (solderless) terminals to crimping (solderless) sockets, to maintain reliable performance, please do not insert obliquely. ■DO NOT mate/un-mate non-terminated plugs with non-mounted receptacles. This may lead to damage or deformation of the contacts. ■Removal of the holding electric cable may cause damage so please be careful. ■DO NOT apply flux to the contact terminals when hand soldering the receptacle to the board. Wicking of the flux into the electrical contact areas may lead to connection failures. ■Slight discoloration on the insulating materials will not affect form, fit or function of the connectors. ■Please refer to the documents "Cable assembly Procedure", "Crimp condition" and "Crimp quality standards" for the cable assembly procedures. ■Please refer to the "Mating/Unmating Operation Instruction Manual" for the connector operation.

7. Insertion and removal operation method

Mating

- ① Determine position, fitting the external form
- ② Insert the cable side
- ③ Push the contact portion side

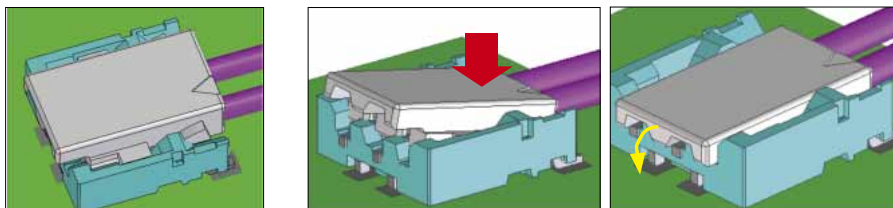

Un-mating

- ① Engage lever
- ② Pull up and release the simple lock
- ③ The reinforced lock is also released and the un-mating is complete

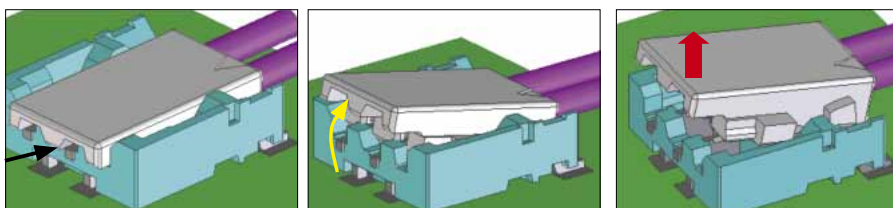

8. Mating compatibility

		DF57H		DF57	
Header					
Socket					
Mating compatibility		Y	Y	N	Y
Additional guiding keys		Y	N	-	N



HIROSE ELECTRIC CO.,LTD.

2-6-3,Nakagawa Chuoh,Tsuzuki-Ku,Yokohama-Shi 224-8540,JAPAN
 TEL: +81-45-620-3526 Fax: +81-45-591-3726
<http://www.hirose.com>
<http://www.hirose-connectors.com>