

SPECIFICATIONS

Customer	
Product Name	Multi-layer Chip Ferrite Bead
Sunlord Part Number	PZ1608D121-2R0TF
Customer Part Number	

New Released, Revised]

SPEC No.: PZ10170002

【This SPEC is total 9 pages including specifications and appendix.】

【ROHS Compliant Parts】

Approved By	Checked By	Issued By
		

Shenzhen Sunlord Electronics Co., Ltd.

Address: Sunlord Industrial Park, Dafuyuan Industrial Zone, Guanlan, Shenzhen, China 518110
 Tel: 0086-755-29832660 Fax: 0086-755-82269029 E-Mail: sunlord@sunlordinc.com

【For Customer approval Only】

Date: _____

Qualification Status: Full Restricted Rejected

Approved By	Verified By	Re-checked By	Checked By

Comments:

【Version change history】

Rev.	Effective Date	Changed Contents	Change Reasons	Approved By
01	Jan.06, 2017	New release	/	Hai Guo

1. Scope

This specification applies to PZ1608D121-2R0TF of multi-layer ferrite chip bead.

2. Product Description and Identification (Part Number)

- 1) Description:
Multi-layer ferrite chip beads.
- 2) Product Identification (Part Number)

PZ 1608 D 121 -2R0 T F
 ① ② ③ ④ ⑤ ⑥ ⑦

①	Type
PZ	For Large current

②	External Dimensions(L X W) [mm]	
1608 [0603]	1.6 X 0.8	

③	Material Code
D	

④	Nominal Impedance	
Example	Nominal Value	
121	120Ω	

⑤	Rate Current
2R0	2.0A

⑦	HSF Products
Hazardous Substance Free Products	

⑥	Packing
T	Tape Carrier Package

3. Electrical Characteristics

Part Number	Impedance (Ω)	Z Test Freq. (MHz)	DCR (Ω) Max.	Ir (mA) Max.
PZ1608D121-2R0TF	120±25%	100	0.050	2000

Impedance Frequency Characteristics

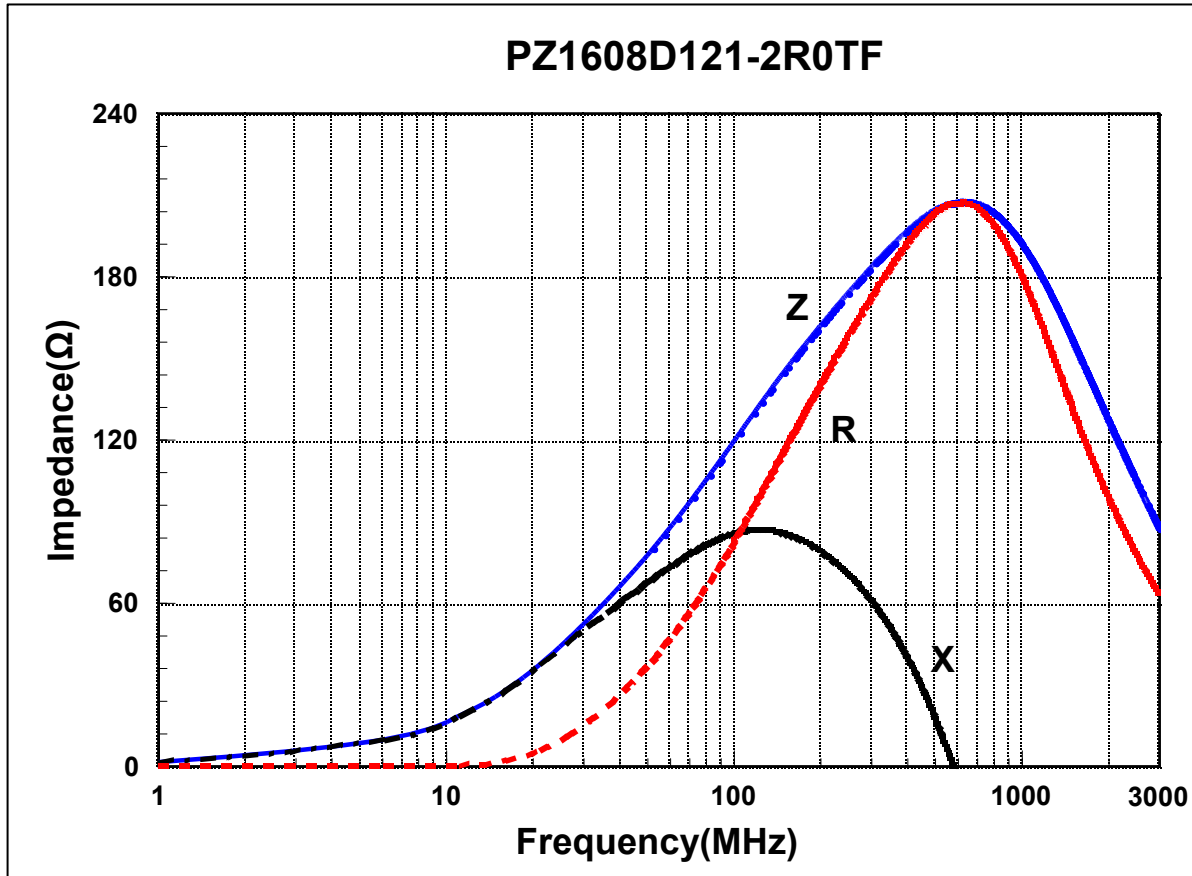

- 1) Operating and storage temperature range (individual chip without packing): -55°C ~ +125°C
- 2) Storage temperature range (packaging conditions): -10°C~+40°C and RH 70% (Max.)

4. Shape and Dimensions

- 1) Dimensions and recommended PCB pattern for reflow soldering: See Fig.4-1, Fig.4-2 and Table 4-1.
- 2) Structure: See Fig. 4-3 and Fig. 4-4.

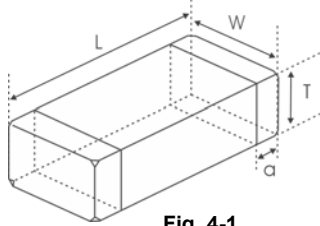

Fig. 4-1

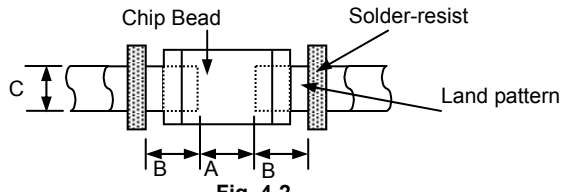

Fig. 4-2

[Table 4-1]

Unit: mm [inch]

Type	L	W	T	a	A	B	C
1608 [0603]	1.6±0.15 [0.063±0.006]	0.8±0.15 [0.031±0.006]	0.8±0.15 [0.031±0.006]	0.3±0.2 [0.012±0.008]	0.60~0.80	0.60~0.80	0.60~0.80

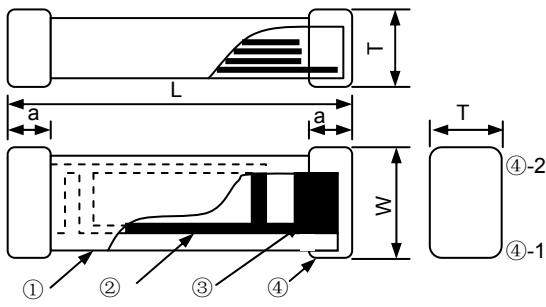

Fig. 4-3

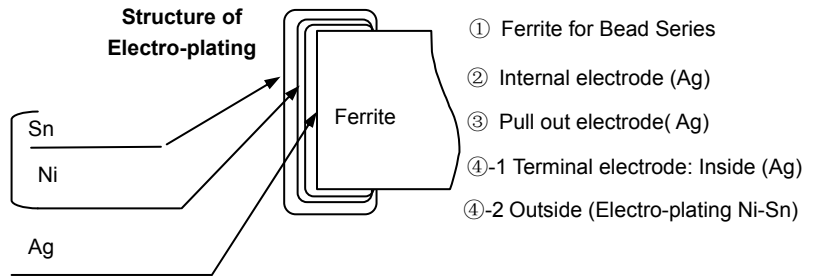

Fig. 4-4

- 3) Material Information: See Table 4-2.

[Table 4-2]

Code	Part Name	Material Name
①	Ferrite Body	Ferrite Powder
②	Inner Coils	Silver Paste
③	Pull-out Electrode (Ag)	Silver Paste
④-1	Terminal Electrode: Inside Ag	Termination Silver Composition
④-2	Electro-Plating: Ni/Sn plating	Plating Chemicals

5. Test and Measurement Procedures

5.1 Test Conditions

Unless otherwise specified, the standard atmospheric conditions for measurement/test as:

- a. Ambient Temperature: 20±15°C
- b. Relative Humidity: 65±20%
- c. Air Pressure: 86kPa to 106kPa

If any doubt on the results, measurements/tests should be made within the following limits:

- a. Ambient Temperature: 20±2°C
- b. Relative Humidity: 65±5%
- c. Air Pressure: 86kPa to 106kPa

5.2 Visual Examination

- a. Inspection Equipment: 20× magnifier

5.3 Electrical Test

5.3.1 DC Resistance (DCR)

- a. Refer to Item 3.
- b. Test equipment (Analyzer): High Accuracy Milliohmmeter-HP4338B or equivalent.

5.3.2 Impedance (Z)

- a. Refer to Item 3.
- b. Test equipment: High Accuracy RF Impedance /Material Analyzer-E4991A or equivalent.
Test fixture: HP16197A for 0603, HP16192A for 1005/1608/2012/3216/4516.
Test signal: -20dBm or 50mV
- c. Test frequency refers to Item 3.

5.3.3 Rated Current

- a. Refer to **Item 3**.
- b. Test equipment (see **Fig. 5.3.3-1**): Electric Power, Electric current meter, Thermometer.
- c. Measurement method (see **Fig. 5.3.3-1**):
 - 1. Set test current to be 0mA.
 - 2. Measure initial temperature of chip surface.
 - 3. Gradually increase voltage and measure chip temperature for corresponding current.
- d. Definition of Rated Current (I_r): I_r is direct electric current as chip surface temperature rose just 20°C . against chip initial surface temperature(T_a). (see **Fig. 5.3.3-2**):

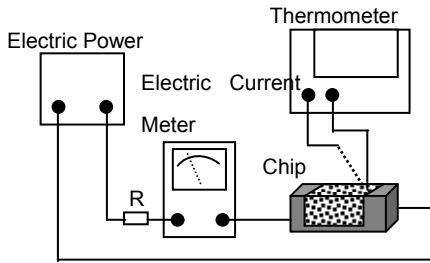

Fig. 5.3.3-1

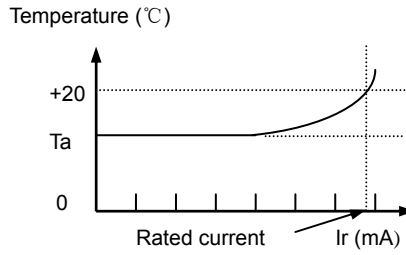

Fig. 5.3.3-2

- e. When operating temperatures exceeding $+85^{\circ}\text{C}$, derating of current is necessary for chip ferrite beads for which rated current is 1000mA and over. Please apply the derating curve shown in chart Fig. 5.3.3-3 according to the operating temperature.

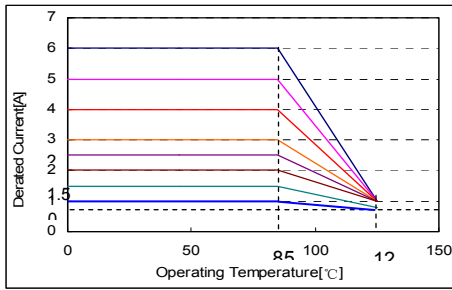
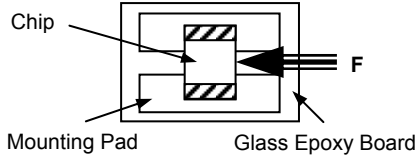
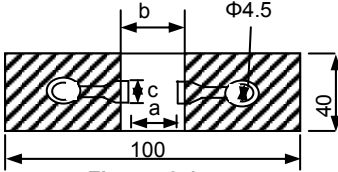
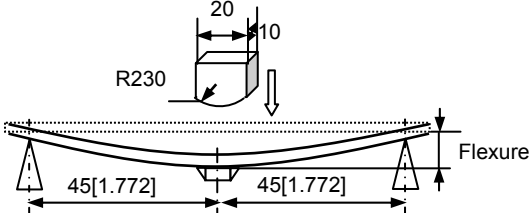
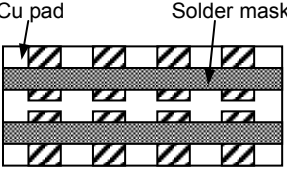
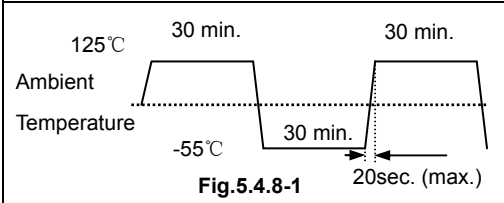

Fig. 5.3.3-3

5.4 Reliability Test

Items	Requirements	Test Methods and Remarks								
5.4.1 Terminal Strength	<p>No removal or split of the termination or other defects shall occur.</p>  <p>Fig.5.4.1-1</p>	<ol style="list-style-type: none"> ① Solder the bead to the testing jig (glass epoxy board shown in Fig. 5.4.1-1) using leadfree solder. Then apply a force in the direction of the arrow. ② 5N force for 1608 series, ③ Keep time: 10±1s. ④ Speed:1.0mm/s. 								
5.4.2 Resistance to Flexure	<p>No visible mechanical damage.</p> <p style="text-align: center;">Unit: mm [inch]</p> <table border="1" data-bbox="328 595 759 680"> <thead> <tr> <th>Type</th> <th>a</th> <th>b</th> <th>c</th> </tr> </thead> <tbody> <tr> <td>1608[0603]</td> <td>1.0</td> <td>3.0</td> <td>1.2</td> </tr> </tbody> </table>  <p>Fig. 5.4.2-1</p>	Type	a	b	c	1608[0603]	1.0	3.0	1.2	<ol style="list-style-type: none"> ① Solder the bead to the test jig (glass epoxy board shown in Fig. 5.4.2-1) Using a leadfree solder. Then apply a force in the direction shown Fig. 5.4.2-2. ② Flexure: 2mm. ③ Pressurizing Speed: 0.5mm/sec. ④ Keep time: 30 sec.  <p>Fig. 5.4.2-2</p>
Type	a	b	c							
1608[0603]	1.0	3.0	1.2							
5.4.3 Vibration	<ol style="list-style-type: none"> ① No visible mechanical damage. ② Impedance change: within ±20%.  <p>Fig. 5.4.3-1</p>	<ol style="list-style-type: none"> ① Solder the bead to the testing jig (glass epoxy board shown in Fig. 5.4.3-1) using leadfree solder. ② The bead shall be subjected to a simple harmonic motion having total amplitude of 1.5mm, the frequency being varied uniformly between the approximate limits of 10 and 55 Hz. ③ The frequency range from 10 to 55 Hz and return to 10 Hz shall be traversed in approximately 1 minute. This motion shall be applied for a period of 2 hours in each 3 mutually perpendicular directions (total of 6 hours). 								
5.4.4 Dropping	<ol style="list-style-type: none"> ① No visible mechanical damage. ② Impedance change: within ±20%. 	<p>Drop chip bead 10 times on a concrete floor from a height of 100 cm.</p>								
5.4.5 Temperature	<p>Impedance change should be within ±20% of initial value measuring at 20°C.</p>	<p>Temperature range: -55°C ~ +125°C. Reference temperature: +20°C.</p>								
5.4.6 Solderability	<ol style="list-style-type: none"> ① No visible mechanical damage. ② Wetting shall exceed 75% coverage for 0603 series; exceed 95% for others 	<ol style="list-style-type: none"> ① Solder temperature: 240±2°C. ② Duration: 3 sec. ③ Solder: Sn/3.0Ag/0.5Cu. ④ Flux: 25% Resin and 75% ethanol in weight. 								

<p>5.4.7 Resistance to Soldering Heat</p>	<p>① No visible mechanical damage. ② Wetting shall exceed 75% coverage for 0603 series; exceed 95% for others ③ Impedance change: within $\pm 20\%$.</p>	<p>① Solder temperature: $260\pm 3^{\circ}\text{C}$ ② Duration: 5 sec. ③ Solder: Sn/3.0Ag/0.5Cu. ④ Flux: 25% Resin and 75% ethanol in weight. ⑤ The chip shall be stabilized at normal condition for 1~2 hours before measuring.</p>
<p>5.4.8 Thermal Shock</p>	<p>① No mechanical damage. ② Impedance change: Within $\pm 20\%$</p>  <p style="text-align: center;">Fig.5.4.8-1</p>	<p>① Temperature, Time: (See Fig. 5.4.8-1) -55°C for 30±3 min→125°C for 30±3min ② Transforming interval: Max. 20 sec. ③ Tested cycle: 100 cycles. ④ The chip shall be stabilized at normal condition for 1~2 hours before measuring.</p>
<p>5.4.9 Resistance to Low Temperature</p>	<p>① No mechanical damage. ② Impedance change: within $\pm 20\%$</p>	<p>① Temperature: $-55\pm 2^{\circ}\text{C}$ ② Duration: 1000^{+24} hours. ③ The chip shall be stabilized at normal condition for 1~2 hours before measuring.</p>
<p>5.4.10 Resistance to High Temperature</p>	<p>① No mechanical damage. ② Impedance change: within $\pm 20\%$</p>	<p>① Temperature: $125\pm 2^{\circ}\text{C}$. ② Duration: 1000^{+24} hours. ③ The chip shall be stabilized at normal condition for 1~2 hours before measuring.</p>
<p>5.4.11 Damp Heat (Steady States)</p>	<p>① No visible mechanical damage. ② Impedance change: within $\pm 20\%$</p>	<p>① Temperature: $60\pm 2^{\circ}\text{C}$. ② Humidity: 90% to 95% RH. ③ Duration: 1000^{+24} hours. ④ The chip shall be stabilized at normal condition for 1~2 hours before measuring.</p>
<p>5.4.12 Loading Under Damp Heat</p>	<p>① No visible mechanical damage. ② Impedance change: within $\pm 20\%$</p>	<p>① Temperature: $60\pm 2^{\circ}\text{C}$. ② Humidity: 90% to 95% RH. ③ Duration: 1000^{+24} hours. ④ Applied current: Rated current. ⑤ The chip shall be stabilized at normal condition for 1~2 hours before measuring.</p>
<p>5.4.13 Loading at High Temperature (Life Test)</p>	<p>① No visible mechanical damage. ② Impedance change: within $\pm 20\%$</p>	<p>① Temperature: $85\pm 2^{\circ}\text{C}$ ② Duration: 1000^{+24} hours. ③ Applied current: Rated current. ④ The chip shall be stabilized at normal condition for 1~2 hours before measuring.</p>

6. Packaging, Storage

6.1 Packaging

Tape Carrier Packaging:

Packaging code: T

- a. Tape carrier packaging are specified in attached figure **Fig. 6.1-1~3**
- b. Tape carrier packaging quantity please see the following table:

Type	1608[0603]
T(mm)	0.8±0.15
Tape	Paper Tape
Quantity	4K

(1) Taping Drawings (Unit: mm)

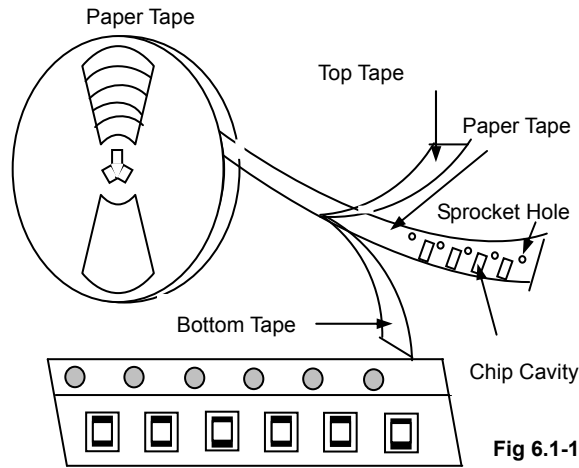

Remark: The sprocket holes are to the right as the tape is pulled toward the user.

(2) Taping Dimensions (Unit: mm)

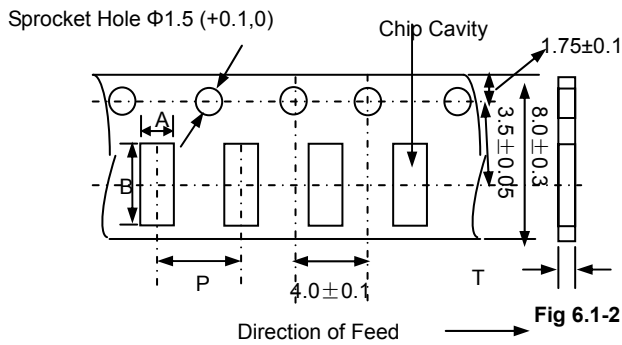

Paper Tape and Reel

Type	A	B	P	T max	H
1608[0603]	1.0 ± 0.2	1.8 ± 0.2	4.0 ± 0.1	1.1	¹⁰

Fig 6.1-2

(3) Reel Dimensions (Unit: mm)

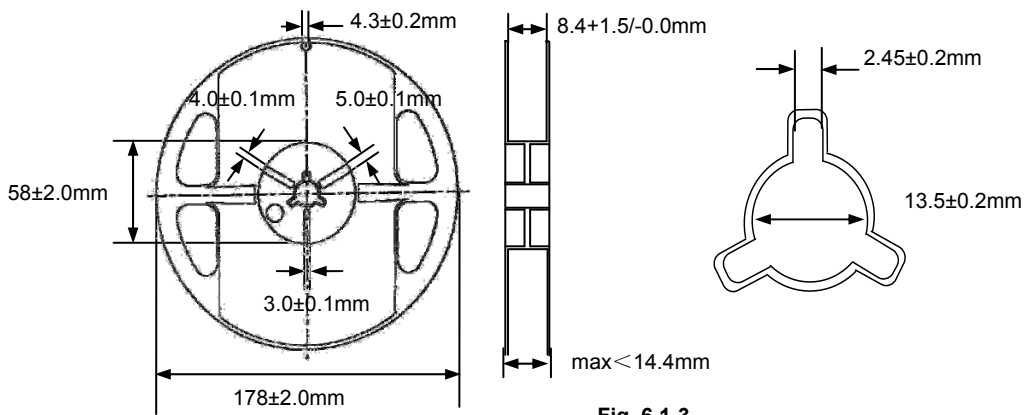

Fig. 6.1-3

6.2 Storage

- The solderability of the external electrode may be deteriorated if packages are stored where they are exposed to high humidity. Package must be stored at 40°C or less and 70% RH or less.
- The solderability of the external electrode may be deteriorated if packages are stored where they are exposed to dust of harmful gas (e.g. HCl, sulfurous gas of H_2S).
- Packaging material may be deformed if package are stored where they are exposed to heat of direct sunlight.
- Solderability of the products with external dimensions as 0603[0201] specified in **Clause 5.4.6** shall be guaranteed for 6months from the date of delivery on condition that they are stored at the environment specified in **Clause 3**. For those parts, which passed more than 6 months shall be checked solder-ability before use.
- Solderability of the products, except ones with external dimensions as 0603[0201], specified in **Clause 5.4.6** shall be guaranteed for 12 months from the date of delivery on condition that they are stored at the environment specified in **Clause 3**. For those parts, which passed more than 12 months shall be checked solder-ability before use.

7. Recommended Soldering Technologies

7.1 Reflowing Profile:

- △ Preheat condition: 150 ~200°C/60~120sec.
- △ Allowed time above 217°C: 60~90sec.
- △ Max temp: 260°C
- △ Max time at max temp: 10sec.
- △ Solder paste: Sn/3.0Ag/0.5Cu
- △ Allowed Reflow time: 2x max

[Note: The reflow profile in the above table is only for qualification and is not meant to specify board assembly profiles. Actual board assembly profiles must be based on the customer's specific board design, solder paste and process, and should not exceed the parameters as the Reflow profile shows.]

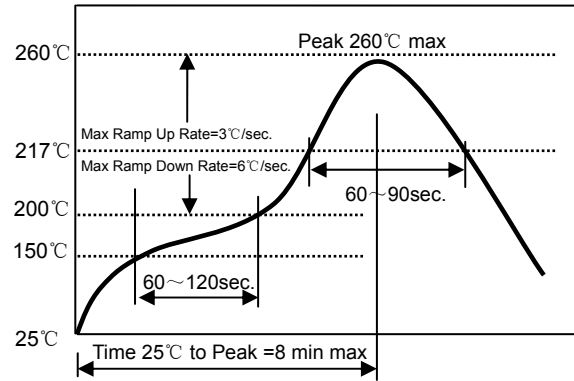

7.2 Iron Soldering Profile.

- △ Iron soldering power: Max.30W
- △ Pre-heating: 150 °C / 60sec.
- △ Soldering Tip temperature: 350°C Max.
- △ Soldering time: 3sec Max.
- △ Solder paste: Sn/3.0Ag/0.5Cu
- △ Max.1 times for iron soldering

[Note: Take care not to apply the tip of the soldering iron to the terminal electrodes.]

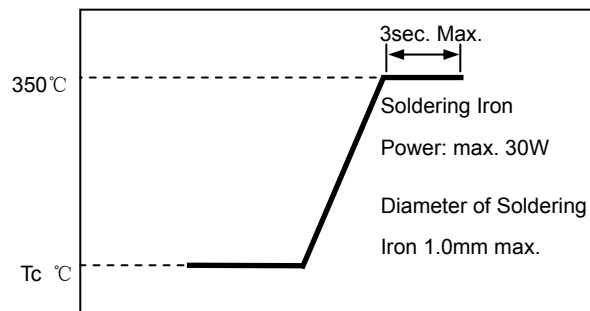

8. Supplier Information

a) Supplier:

Shenzhen Sunlord Electronics Co., Ltd.

b) Manufacturer:

Shenzhen Sunlord Electronics Co., Ltd.

c) Manufacturing Address:

Sunlord Industrial Park, Dafuyuan Industrial Zone, Guanlan, Shenzhen, China 518110