

● Features:

1. Current transfer ratio (CTR: MIN. 50% at $I_F=5\text{mA}$, $V_{CE}=5\text{V}$)
2. High input-output isolation voltage ($V_{ISO}=5,000\text{Vrms}$)
3. Response time (t_r : TYP. $4\mu\text{s}$ at $V_{CE}=2\text{V}$, $I_C=2\text{mA}$, $R_L=100\ \Omega$)
4. UL approved (NO.E236324)
5. CSA approved (NO.218896)
6. VDE approved (NO.40007240)
7. TUV approved (NO.R50029014)
8. FIMKO approved (NO.FI 23724)
9. NEMKO approved (NO.P06206181)
10. SEMKO approved (NO.712540)
11. This product doesn't contain restriction substance, comply RoHS standard

● Description

1. The BPC-817S series are optically coupled isolators containing a GaAs light emitting diode and an NPN silicon phototransistor
2. The lead pitch is 2.54mm

● Applications:

1. Computer terminals.
2. System appliances, measuring instruments.
3. Registers, copiers, automatic vending machines.
4. Electric home appliances, such as fan heaters, etc.
5. Signal transmission between circuits of different potentials and impedances.

● Absolute Maximum Ratings ($T_a=25^\circ\text{C}$)

Parameter		Symbol	Rating	Unit
INPUT	Forward Current	I_F	50	mA
	Reverse Voltage	V_R	6	V
	Power Dissipation	P	70	mW
OUTPUT	Collector-Emitter Voltage	V_{CEO}	35	V
	Emitter- Collector Voltage	V_{ECO}	6	
	Collector Current	I_C	50	mA
	Collector Power Dissipation	P_C	150	mW
Total Power Dissipation		P_{tot}	200	mW
*1 Isolation Voltage		V_{iso}	5,000	Vrms
Rated impulse isolation voltage		V_{IOTM}	6,000	V
Rated repetitive peak isolation voltage		V_{IORM}	630	V
Operating Temperature		T_{op}	-40 to +100	°C
Storage Temperature		T_{stg}	-55 to +125	
*2 Soldering Temperature		T_{sol}	260	

*1. AC For minute, R.H. =40~60%

Isolation voltage shall be measured using the following method.

- (1) Short between anode and cathode on the primary side and between collector and emitter on the secondary side.
- (2) The isolation voltage tester with zero-cross circuit shall be used.
- (3) The waveform of applied voltage shall be a sine wave.

*2. For 10 Seconds

● Outline Dimensions

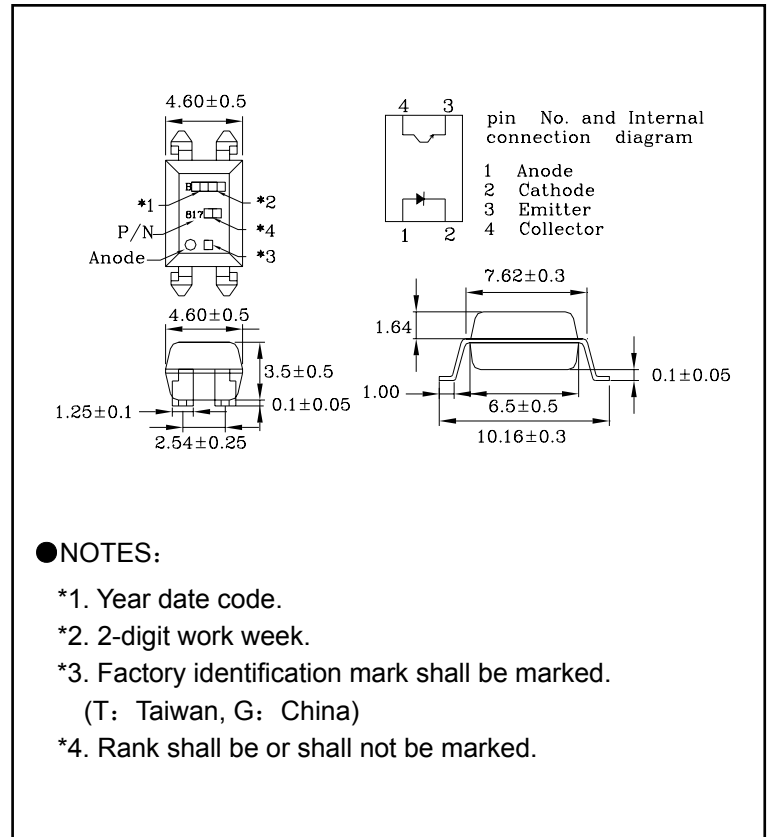

● NOTES:

- *1. Year date code.
- *2. 2-digit work week.
- *3. Factory identification mark shall be marked.
(T: Taiwan, G: China)
- *4. Rank shall be or shall not be marked.

● Electro-Optical Characteristics (Ta=25°C)

Parameter		Symbol	Conditions	MIN.	TYP.	MAX.	Unit
INPUT	Forward Voltage	V_F	$I_F=20\text{mA}$	---	1.2	1.4	V
	Reverse Current	I_R	$V_R=4\text{V}$	---	---	10	μA
	Terminal Capacitance	C_t	$V=0, f=1\text{KHz}$	---	30	250	pF
OUTPUT	Collector Dark Current	I_{CEO}	$V_{CE}=20\text{V}, I_F=0$	---	---	100	nA
	Collector-Emitter Breakdown Voltage	BV_{CEO}	$I_C=0.1\text{mA}$ $I_F=0$	35	---	---	V
	Emitter-Collector Breakdown Voltage	BV_{ECO}	$I_E=10\mu\text{A}$ $I_F=0$	6	---	---	V
TRANSFER CHARACTERISTICS	Collector Current	I_c	$I_F=5\text{mA}$	2.5	---	30	mA
	*1 Current Transfer Ratio	CTR	$V_{CE}=5\text{V}$	50	---	600	%
	Collector-Emitter Saturation Voltage	$V_{CE(sat)}$	$I_F=20\text{mA}$ $I_C=1\text{mA}$	---	0.1	0.2	V
	Isolation Resistance	R_{iso}	DC500V 40~60%R.H.	5×10^{10}	1×10^{11}	---	Ω
	Floating Capacitance	C_f	$V=0, f=1\text{MHz}$	---	0.6	1	pF
	Cut-Off Frequency	f_c	$V_{CE}=5\text{V},$ $I_C=2\text{mA}$ $R_L=100\Omega,$ -3dB	---	80	---	kHz
	Response Time(Rise)	t_r	$V_{CE}=2\text{V},$ $I_C=2\text{mA}$	---	4	18	μs
	Response Time(Fall)	t_f	$R_L=100\Omega$	---	3	18	μs

*1 $CTR = I_c / I_F \times 100\%$

● RANK TABLE OF CURRENT TRANSFER RATIO(CTR)

RANK MARK	Min. (%)	Max. (%)
L	50	100
A	80	160
B	130	260
C	200	400
D	300	600
L or A or B or C or D	50	600

Notes:

1. Conditions: $I_F=5\text{mA}, V_{CE}=5\text{V}, T_a=25^\circ\text{C}.$

● CHARACTERISTICS CURVES

Fig.1 Forward Current vs. Ambient Temperature

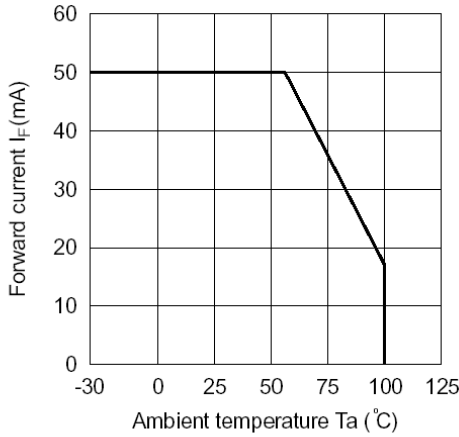

Fig.2 Collector Power Dissipation vs. Ambient Temperature

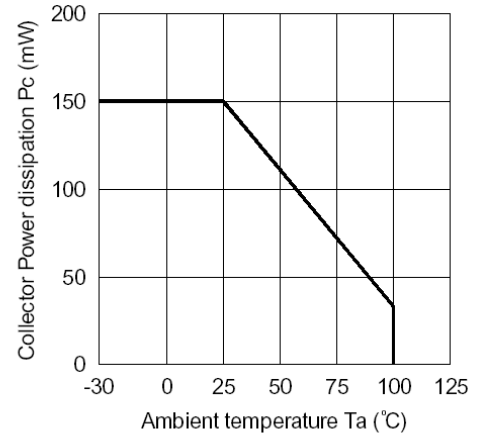

Fig.3 Collector-emitter Saturation Voltage vs. Forward Current

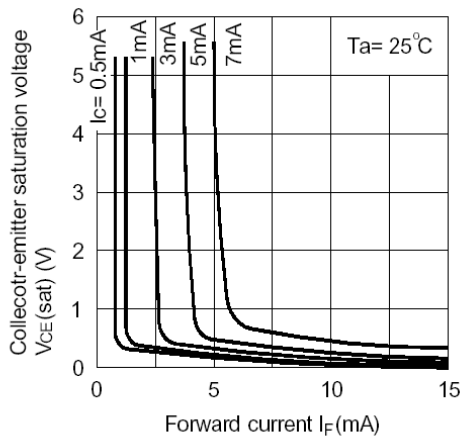

Fig.4 Forward Current vs. Forward Voltage

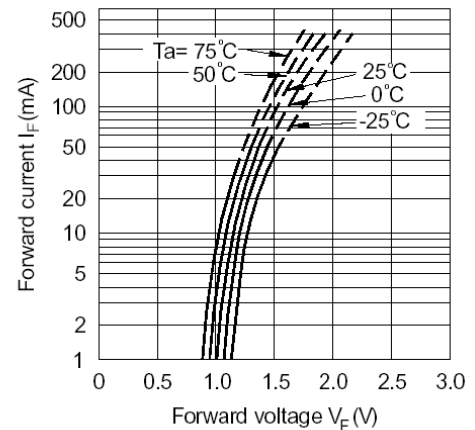

Fig.5 Current Transfer Ratio vs. Forward Current

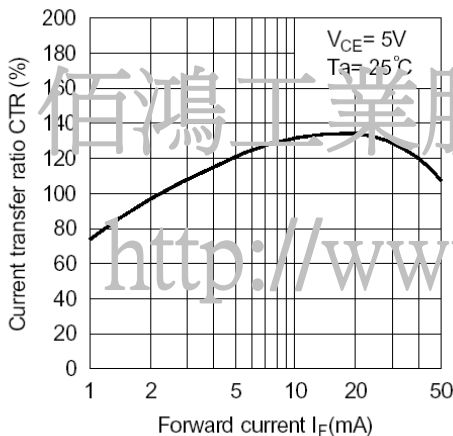
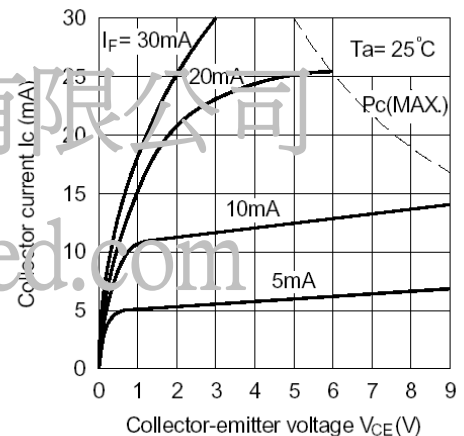

Fig.6 Collector Current vs. Collector-emitter Voltage



● Characteristics Curves

Fig.7 Relative Current Transfer Ratio vs. Ambient Temperature

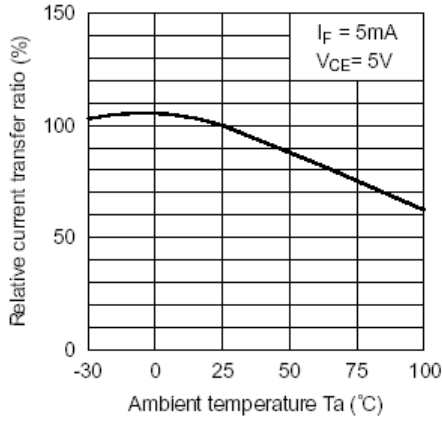

Fig.8 Collector-emitter Saturation Voltage vs. Ambient Temperature

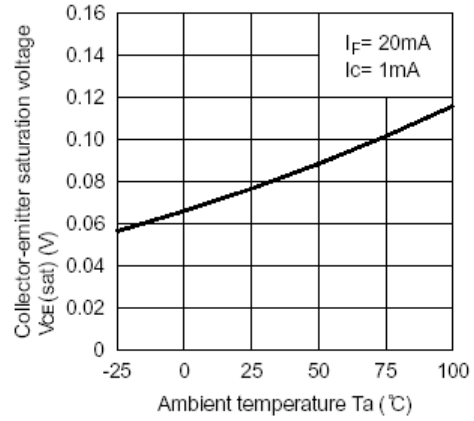

Fig.9 Collector Dark Current vs. Ambient Temperature

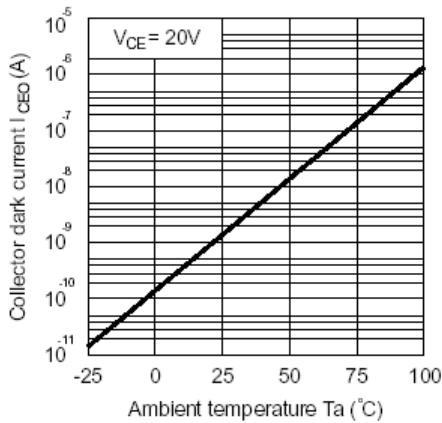

Fig.10 Response Time vs. Load Resistance

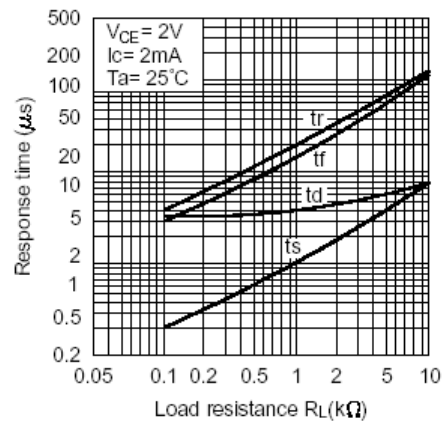
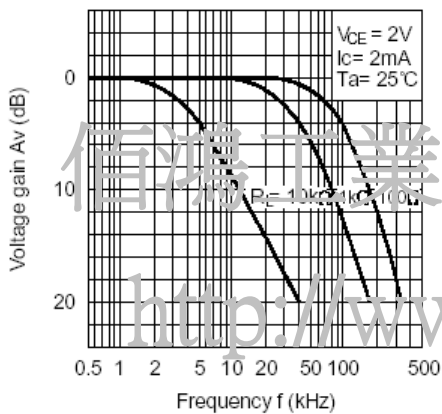
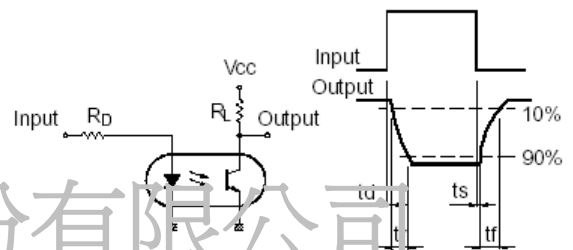

Fig.11 Frequency Response



Test Circuit for Response Time



Test Circuit for Frequency Response

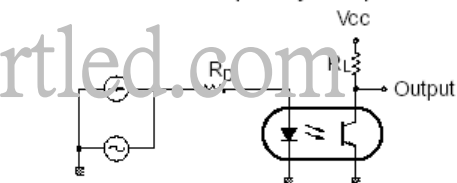

● Reliability Test

Classification	Test Item	Reference Standard	Test Conditions	Result
Endurance Test	Operation Life	MIL-STD-750:1026 MIL-STD-883:1005 JIS C 7021 :B-1	Connect with a power $I_f=50\text{mA}$ T_a =Under room temperature Test time=1,000hrs	0/20
	High Temperature High Humidity Reverse Bias (H3TRB)	JIS C 7021 :B-11	$T_a=+85^\circ\text{C}\pm 5^\circ\text{C}$, RH=85% PTR= V_{CE} absolute max rating*80% Test time=1000hrs	0/20
	High Temperature Reverse Bias (HTRB)	JIS C 7021 :B- 8	$T_a=+105^\circ\text{C}\pm 5^\circ\text{C}$ PTR= V_{CE} absolute max rating Test time=1000hrs	0/20
	High Temperature Storage	MIL-STD-883:1008 JIS C 7021 :B-10	High $T_a=+125^\circ\text{C}\pm 5^\circ\text{C}$ Test time=1,000hrs	0/20
	Low Temperature Storage	JIS-C-7021 :B-12	Low $T_a=-55^\circ\text{C}\pm 5^\circ\text{C}$ Test time=1,000hrs	0/20
	Autoclave	JESD 22-A102-B	P=15PSIG, $T_a=121^\circ\text{C}$ Humi. =100%RH, 48hrs	0/20
Environmental Test	Temperature Cycling	MIL-STD-202:107D MIL-STD-750:1051 MIL-STD-883:1010 JIS C 7021 :A-4	$125^\circ\text{C} \sim 25^\circ\text{C} \sim -55^\circ\text{C} \sim 25^\circ\text{C}$ 30min 5min 30min 5min Test Time=20cycle	0/20
	Thermal Shock	MIL-STD-202:107D MIL-STD-750:1051 MIL-STD-883:1011	$125^\circ\text{C} \sim -55^\circ\text{C}$ 20min 20min Test Time=20cycle	0/20
	Solder Resistance	MIL-STD-202:201A MIL-STD-750:2031 JIS C 7021 :A-1	Operation heating : 260°C , within 10 ± 1 seconds.	0/20
	Solder Ability	MIL-S-883:2003 JIS C 7021 :A-2	Operation heating : 235°C , within 5 ± 1 seconds.	0/20

● Judgment Criteria Of Failure For The Reliability

Symbol	Measuring conditions	Judgment criteria for failure
V_F (V)	$I_f=20\text{mA}$	Over $U_x1.0$
I_r (μA)	$V_r=4\text{V}$	Over $U_x1.0$
CTR(%)	$I_f=5\text{mA}$, $V_{CE}=5\text{V}$	Shift>1.2
$V_{CE(sat)}$	$I_f=20\text{mA}$, $I_c=1\text{mA}$	Over $U_x1.0$
BV_{CEO}	$I_c=0.1\text{mA}$, $I_f=0$	Over $L_x1.0$
BV_{ECO}	$I_E=10\mu\text{A}$, $I_f=0$	Over $L_x1.0$

● Packaging Box Dimensions (Units: mm)

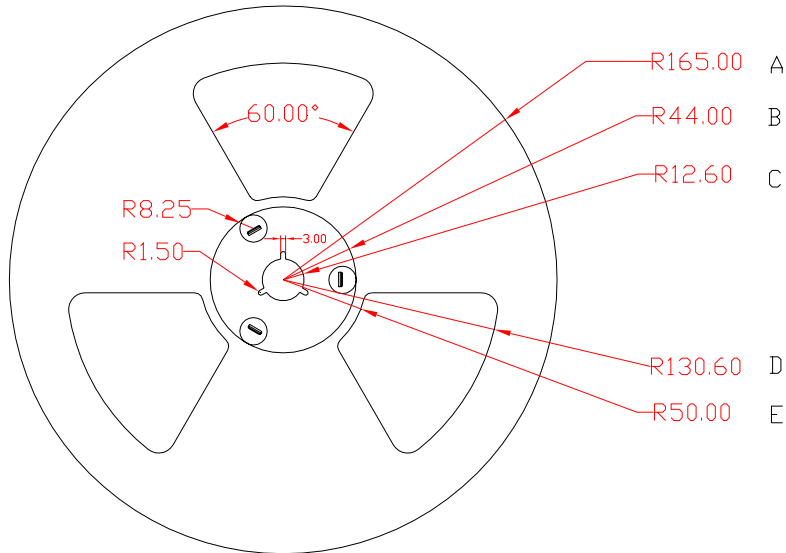

● Packaging Tube Dimensions

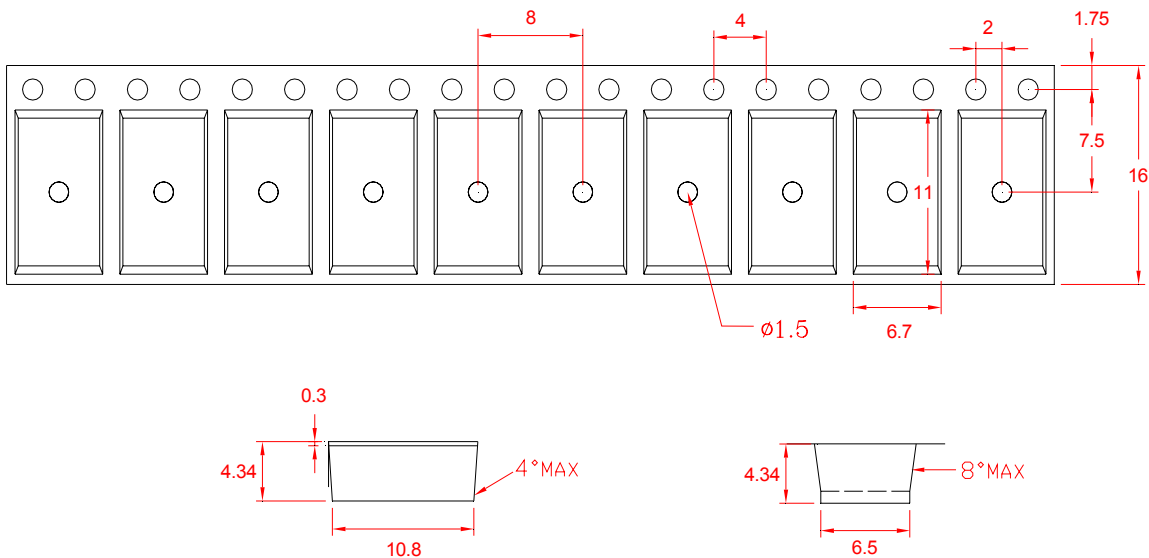

佰鴻工業股份有限公司

Notes:

- 1、2000 PCS per reel, 10 reels per box.
- 2、All dimensions are in millimeters (inches).
- 3、Specifications are subject to change without notice.

<http://www.brtled.com>