



# 2SD1691

## NPN SILICON TRANSISTOR

LOW COLLECTOR  
SATURATION VOLTAGE  
LARGE CURRENT

■ FEATURES

- \*High Power Dissipation
- \*Complementary to 2SB1151

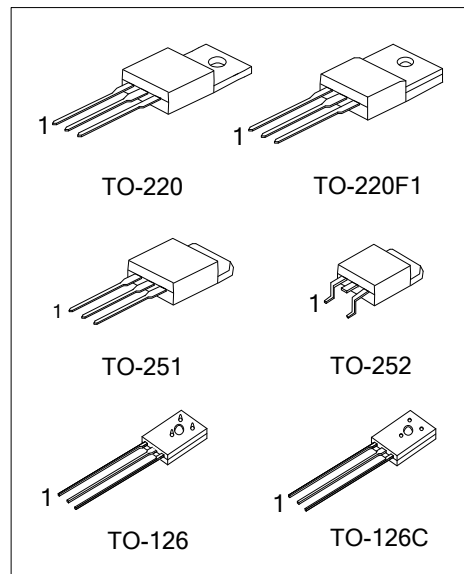

■ ORDERING INFORMATION

Ordering Number		Package	Pin Assignment			Packing
Lead Free Plating	Halogen Free		1	2	3	
2SD1691L-x-TA3-T	2SD1691G-x-TA3-T	TO-220	B	C	E	Tube
2SD1691L-x-TF1-T	2SD1691G-x-TF1-T	TO-220F1	B	C	E	Tube
2SD1691L-x-TM3-T	2SD1691G-x-TM3-T	TO-251	B	C	E	Tube
2SD1691L-x-TN3-T	2SD1691G-x-TN3-T	TO-252	B	C	E	Tape Reel
2SD1691L-x-T60-K	2SD1691G-x-T60-K	TO-126	E	C	B	Bulk
2SD1691L-x-T6C-K	2SD1691G-x-T6C-K	TO-126C	E	C	B	Bulk

Note: Pin Assignment: B: Base C: Collector E: Emitter

<p>2SD1691L-x-TA3-T</p> <p>(1) Packing Type (2) Package Type (3) Rank (4) Green Package</p>	<p>(1) K: Bulk, T: Tube, R: Tape Reel (2) TA3: TO-220, TF1: TO-220F1, TN3: TO-252, TM3: TO-251, T60: TO-126, T6C: TO-126C (3) x: refer to Classification of <math>h_{FE2}</math> (4) L: Lead Free, G: Halogen Free and Lead Free</p>
---	--

■ MARKING

TO-220 / TO-220F1 / TO-251 / TO-252	TO-126 / TO-126C
<p>UTC 2SD1691 □ □ □ □ □ □ □ Lot Code ← → Data Code L: Lead Free G: Halogen Free</p>	<p>UTC □ □ □ □ □ 2SD1691 □ Data Code L: Lead Free G: Halogen Free</p>

■ ABSOLUTE MAXIMUM RATINGS ( $T_A=25^\circ\text{C}$ , unless otherwise specified)

PARAMETER		SYMBOL	RATING	UNIT
Collector-Base Voltage		$V_{CBO}$	60	V
Collector-Emitter Voltage		$V_{CEO}$	60	V
Emitter-Base Voltage		$V_{EBO}$	7	V
Collector Current	DC	$I_C$	5	A
	Pulse ( $PW \leq 10\text{ms}$ , Duty Cycle $\leq 50\%$ )	$I_{CP}$	8	
Base Current		$I_B$	1	A
Collector Power Dissipation ( $T_c=25^\circ\text{C}$ )	TO-220F1	$P_C$	23	W
	TO-220		54	
	TO-251/TO-252		36	
	TO-126/ TO-126C		20	
Junction Temperature		$T_J$	150	$^\circ\text{C}$
Storage Temperature Range		$T_{STG}$	-55 ~ +150	$^\circ\text{C}$

Note: Absolute maximum ratings are those values beyond which the device could be permanently damaged. Absolute maximum ratings are stress ratings only and functional device operation is not implied.

■ ELECTRICAL CHARACTERISTICS ( $T_A=25^\circ\text{C}$ , unless otherwise specified)

CHARACTERISTIC		SYMBOL	TEST CONDITIONS	MIN	TYP	MAX	UNIT
Collector Cut-off Current		$I_{CBO}$	$V_{CB}=50\text{V}, I_E=0$			10	$\mu\text{A}$
Emitter Cut-off Current		$I_{EBO}$	$V_{EB}=7\text{V}, I_C=0$			10	$\mu\text{A}$
DC Current Gain		$h_{FE1}$	$V_{CE}=1\text{V}, I_C=0.1\text{A}$	60			
		$h_{FE2}$	$V_{CE}=1\text{V}, I_C=2\text{A}$	160		400	
		$h_{FE3}$	$V_{CE}=2\text{V}, I_C=5\text{A}$	50			
Collector-Emitter Saturation Voltage		$V_{CE(SAT)}$ (Note)	$I_C=2\text{A}, I_B=0.2\text{A}$		0.1	0.3	V
Base-Emitter Saturation Voltage		$V_{BE(SAT)}$ (Note)	$I_C=2\text{A}, I_B=0.2\text{A}$		0.9	1.2	V
Switching Time	Turn On Time	$T_{ON}$			0.2	1	$\mu\text{s}$
	Storage Time	$T_{STG}$			1.1	2.5	
	Fall Time	$T_F$			0.2	1	

Note: Pulse test:  $P_W \leq 50\mu\text{s}$ , Duty Cycle  $\leq 2\%$  Pulse

■ CLASSIFICATION OF  $h_{FE2}$

RANK	O	Y
RANGE	160-320	200-400

## TYPICAL CHARACTERISTICS

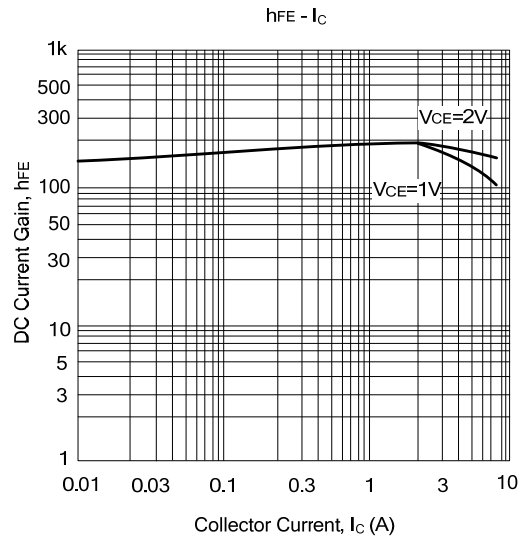
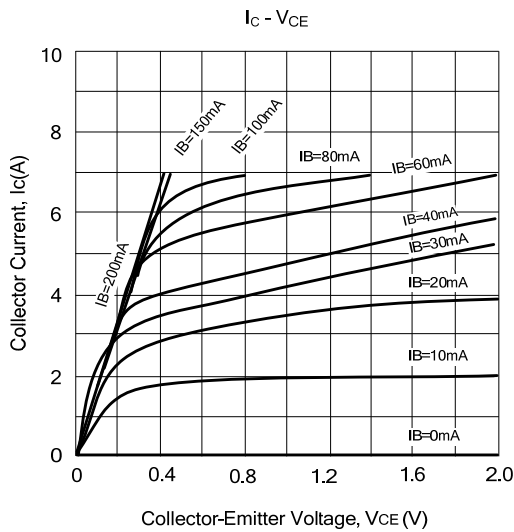
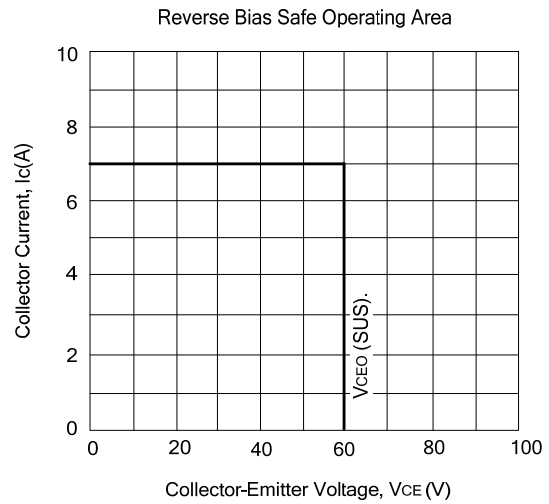
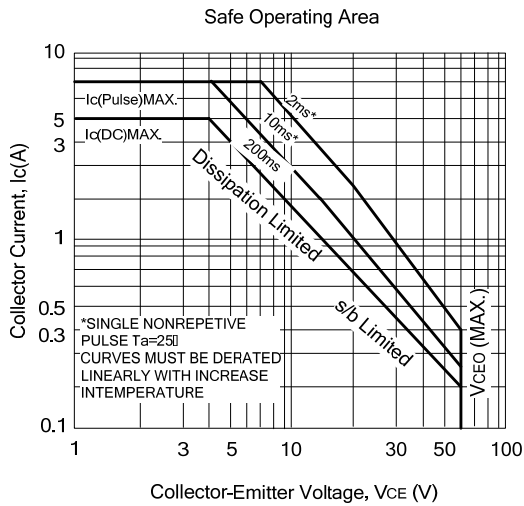
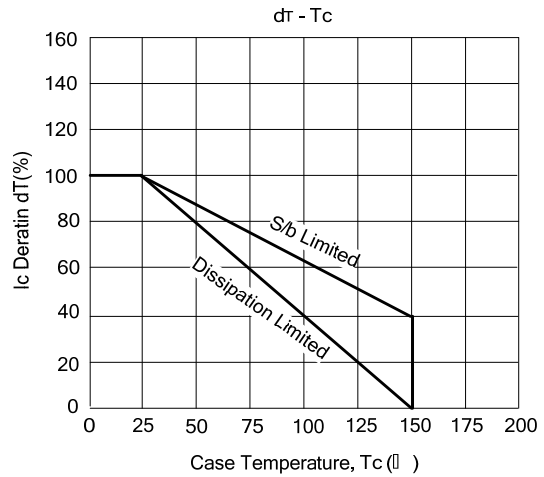
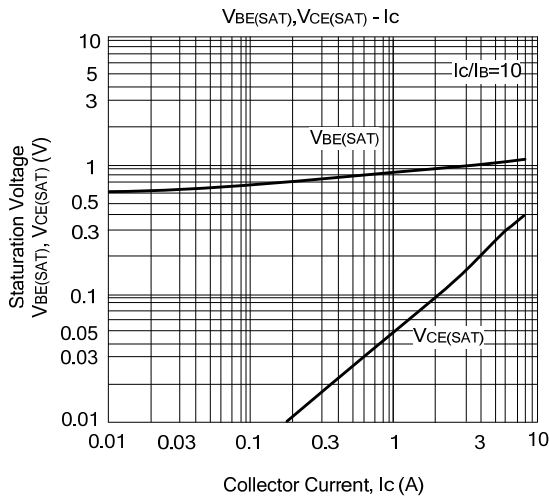

UTC assumes no responsibility for equipment failures that result from using products at values that exceed, even momentarily, rated values (such as maximum ratings, operating condition ranges, or other parameters) listed in products specifications of any and all UTC products described or contained herein. UTC products are not designed for use in life support appliances, devices or systems where malfunction of these products can be reasonably expected to result in personal injury. Reproduction in whole or in part is prohibited without the prior written consent of the copyright owner. The information presented in this document does not form part of any quotation or contract, is believed to be accurate and reliable and may be changed without notice.