

# DATA SHEET

## SURFACE-MOUNT CERAMIC MULTILAYER CAPACITORS

General Purpose & High Capacitance

Class 2, X7R

6.3 V TO 50 V

100 pF to 22  $\mu$ F

RoHS compliant & Halogen Free



SCOPE

This specification describes X7R series chip capacitors with lead-free terminations.

APPLICATIONS

- PCs, Hard disk, Game PCs
- DVDs, Video cameras
- Mobile phones
- Data processing

FEATURES

- Supplied in tape on reel
- Nickel-barrier end termination
- RoHS compliant
- Halogen Free compliant

ORDERING INFORMATION - GLOBAL PART NUMBER, PHYCOMP

CTC & I2NC

All part numbers are identified by the series, size, tolerance, TC material, packing style, voltage, process code, termination and capacitance value.

**YAGEO BRAND ordering code**

**GLOBAL PART NUMBER (PREFERRED)**

**CC** xxxx x x **X7R** x **BB** xxx  
 (1) (2) (3) (4) (5)

---

**(1) SIZE – INCH BASED (METRIC)**

- 0201 (0603)
- 0402 (1005)
- 0603 (1608)
- 0805 (2012)
- 1206 (3216)
- 1210 (3225)
- 1812 (4532)

---

**(2) TOLERANCE**

- J = ±5% <sup>(1)</sup>
- K = ±10%
- M = ±20%

---

**(3) PACKING STYLE**

- R = Paper/PE taping reel; Reel 7 inch
- K = Blister taping reel; Reel 7 inch
- P = Paper/PE taping reel; Reel 13 inch
- F = Blister taping reel; Reel 13 inch

---

**(4) RATED VOLTAGE**

- 5 = 6.3 V
- 6 = 10 V
- 7 = 16 V
- 8 = 25 V
- 9 = 50 V

---

**(5) CAPACITANCE VALUE**

2 significant digits+number of zeros  
 The 3rd digit signifies the multiplying factor, and letter R is decimal point  
 Example: 103 = 10 × 10<sup>3</sup> = 10,000 pF = 10 nF

**NOTE**

1. Tolerance ±5% is not available for full product range, please contact local sales force before ordering

**CONSTRUCTION**

The capacitor consists of a rectangular block of ceramic dielectric in which a number of interleaved metal electrodes are contained. This structure gives rise to a high capacitance per unit volume.

The inner electrodes are connected to the two end terminations and finally covered with a layer of plated tin (NiSn). The terminations are lead-free. A cross section of the structure is shown in Fig.1.

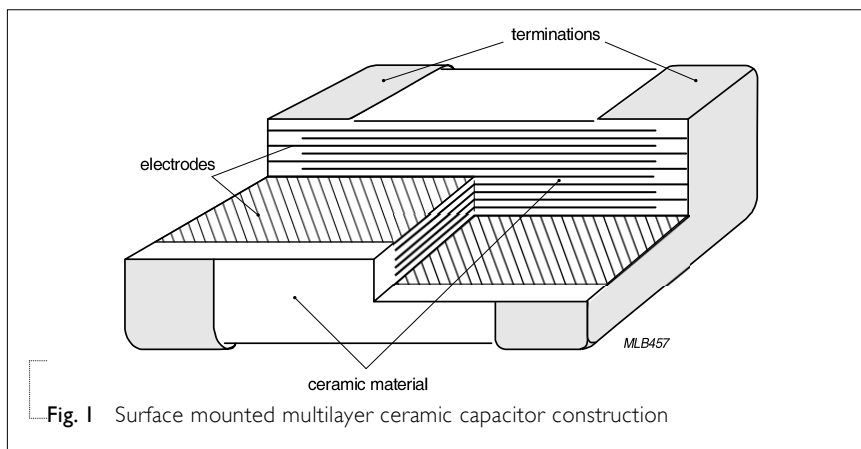

Fig. 1 Surface mounted multilayer ceramic capacitor construction

**DIMENSION**

Table I For outlines see fig. 2

TYPE	L <sub>1</sub> (mm)	W (mm)	T (MM)	L <sub>2</sub> / L <sub>3</sub> (mm)		L <sub>4</sub> (mm)	DIMENSION CODE
				min.	Max.		
0201	0.6 ±0.03	0.3 ±0.03	0.3 ±0.03	0.1	0.2	0.2	BA
0402	1.0 ±0.05	0.5 ±0.05	0.5 ±0.05	0.15	0.35	0.4	CA
	1.6 ±0.1	0.8 ±0.1	0.8 ±0.1	0.2	0.6	0.4	DA
0603	1.6 ±0.15	0.8 ±0.15	0.8 ±0.15	0.2	0.6	0.4	DB
	1.6 ±0.2	0.8 ±0.2	0.8 ±0.2	0.2	0.6	0.4	DC
0805	2.0 ±0.1	1.25 ±0.1	0.6 ±0.1	0.25	0.75	0.55	E0
	2.0 ±0.1	1.25 ±0.1	0.85 ±0.1	0.25	0.75	0.55	EA
	2.0 ±0.2	1.25 ±0.2	1.25 ±0.2	0.25	0.75	0.55	EB
1206	3.2 ±0.15	1.6 ±0.15	0.85 ±0.1	0.25	0.75	1.4	F0
	3.2 ±0.2	1.6 ±0.2	1.0 ±0.1	0.25	0.75	1.4	F1
	3.2 ±0.2	1.6 ±0.2	1.15 ±0.1	0.25	0.75	1.4	FA
	3.2 ±0.3	1.6 ±0.2	1.6 ±0.2	0.25	0.8	1.4	FC
	3.2 ±0.3	1.6 ±0.3	1.6 ±0.3	0.3	0.9	1.4	FD
1210	3.2 ±0.2	2.5 ±0.2	0.85 ±0.1	0.25	0.75	1.4	G0
	3.2 ±0.4	2.5 ±0.3	1.15 ±0.1	0.25	0.75	1.4	G1
	3.2 ±0.4	2.5 ±0.3	1.25 ±0.2	0.25	0.75	1.4	GA
	3.2 ±0.4	2.5 ±0.3	1.6 ±0.2	0.25	0.75	1.4	G2
	3.2 ±0.4	2.5 ±0.3	1.9 ±0.2	0.25	0.75	1.4	GB
	3.2 ±0.4	2.5 ±0.3	2.5 ±0.2	0.25	0.75	1.0	GC
1812	4.5 ±0.2	3.2 ±0.2	0.85 ±0.1	0.25	0.75	2.2	JA
	4.5 ±0.2	3.2 ±0.2	1.15 ±0.1	0.25	0.75	2.2	JB
	4.5 ±0.4	3.2 ±0.4	1.6 ±0.2	0.25	0.75	2.2	JC

**OUTLINES**

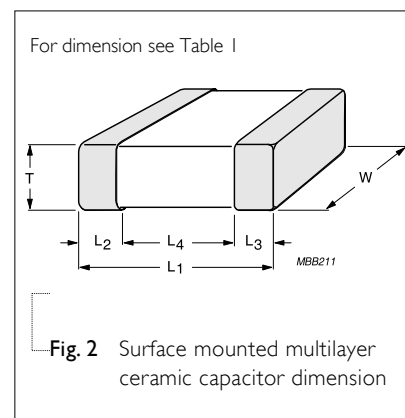

Fig. 2 Surface mounted multilayer ceramic capacitor dimension

**CAPACITANCE RANGE & THICKNESS FOR X7R**

**Table 2** Sizes from 0201 to 0402

CAP.	0201					0402				
	6.3 V	10 V	16 V	25 V	50 V	6.3 V	10 V	16 V	25 V	50 V
100 pF	BA	BA	BA	BA	BA	CA	CA	CA	CA	CA
150 pF	BA	BA	BA	BA	BA	CA	CA	CA	CA	CA
220 pF	BA	BA	BA	BA	BA	CA	CA	CA	CA	CA
330 pF	BA	BA	BA	BA	BA	CA	CA	CA	CA	CA
470 pF	BA	BA	BA	BA	BA	CA	CA	CA	CA	CA
680 pF	BA	BA	BA	BA	BA	CA	CA	CA	CA	CA
1.0 nF	BA	BA	BA	BA	BA	CA	CA	CA	CA	CA
1.5 nF	BA	BA	BA	BA		CA	CA	CA	CA	CA
2.2 nF	BA	BA	BA	BA		CA	CA	CA	CA	CA
3.3 nF	BA	BA	BA	BA		CA	CA	CA	CA	CA
4.7 nF	BA	BA	BA	BA		CA	CA	CA	CA	CA
6.8 nF	BA	BA	BA	BA		CA	CA	CA	CA	CA
10 nF	BA	BA	BA	BA		CA	CA	CA	CA	CA
15 nF						CA	CA	CA	CA	CA
22 nF						CA	CA	CA	CA	CA
33 nF						CA	CA	CA	CA	CA
47 nF						CA	CA	CA	CA	CA
68 nF						CA	CA	CA	CA	
100 nF	BA					CA	CA	CA	CA	CA
150 nF										
220 nF						CA	CA	CA		
330 nF										
470 nF						CA	CA			
680 nF										
1.0 µF						CA				
2.2 µF										
4.7 µF										
10 µF										
22 µF										

**NOTE**

1. Values in shaded cells indicate thickness class in mm
2. Capacitance value of non E-6 series is on request
3. For product with 5% tolerance, please contact local sales force before ordering

**CAPACITANCE RANGE & THICKNESS FOR X7R**

**Table 3** Sizes from 0603 to 0805

CAP.	0603					0805				
	6.3 V	10 V	16 V	25 V	50 V	6.3 V	10 V	16 V	25 V	50 V
100 pF	DA	DA	DA	DA	DA					
150 pF	DA	DA	DA	DA	DA					
220 pF	DA	DA	DA	DA	DA	E0	E0	E0	E0	E0
330 pF	DA	DA	DA	DA	DA	E0	E0	E0	E0	E0
470 pF	DA	DA	DA	DA	DA	E0	E0	E0	E0	E0
680 pF	DA	DA	DA	DA	DA	E0	E0	E0	E0	E0
1.0 nF	DA	DA	DA	DA	DA	E0	E0	E0	E0	E0
1.5 nF	DA	DA	DA	DA	DA	E0	E0	E0	E0	E0
2.2 nF	DA	DA	DA	DA	DA	E0	E0	E0	E0	E0
3.3 nF	DA	DA	DA	DA	DA	E0	E0	E0	E0	E0
4.7 nF	DA	DA	DA	DA	DA	E0	E0	E0	E0	E0
6.8 nF	DA	DA	DA	DA	DA	E0	E0	E0	E0	E0
10 nF	DA	DA	DA	DA	DA	E0	E0	E0	E0	E0
15 nF	DA	DA	DA	DA	DA	E0	E0	E0	E0	E0
22 nF	DA	DA	DA	DA	DA	E0	E0	E0	E0	E0
33 nF	DA	DA	DA	DA	DA	EA	EA	EA	EA	EA
47 nF	DA	DA	DA	DA	DA	EA	EA	EA	EA	EA
68 nF	DA	DA	DA	DA	DA	EA	EA	EA	EA	EA
100 nF	DA	DA	DA	DA	DA	EA	EA	EA	EA	EA
150 nF	DA	DA	DA	DA	DA	EA	EA	EA	EA	EA
220 nF	DA	DA	DA	DA	DA	EA	EA	EA	EA	EB
330 nF	DA	DA	DA	DA		EB	EB	EB	EB	EB
470 nF	DA	DA	DA	DA	DA	EB	EB	EB	EB	EB
680 nF	DA	DA	DA	DA		EB	EB	EB	EB	EB
1.0 µF	DA	DA	DA	DA	DB	EB	EB	EB	EB	EB
2.2 µF	DA	DA	DC			EB	EB	EB	EB	EB
4.7 µF	DC					EB	EB	EB	EB	
10 µF						EB	EB	EB		
22 µF										

**NOTE**

1. Values in shaded cells indicate thickness class in mm
2. Capacitance value of non E-6 series is on request
3. For product with 5% tolerance, please contact local sales force before ordering

**CAPACITANCE RANGE & THICKNESS FOR X7R**

Table 4 Size 1206

CAP.	1206				
	6.3 V	10 V	16 V	25 V	50 V
100 pF					
150 pF					
220 pF	F0	F0	F0	F0	F0
330 pF	F0	F0	F0	F0	F0
470 pF	F0	F0	F0	F0	F0
680 pF	F0	F0	F0	F0	F0
1.0 nF	F0	F0	F0	F0	F0
1.5 nF	F0	F0	F0	F0	F0
2.2 nF	F0	F0	F0	F0	F0
3.3 nF	F0	F0	F0	F0	F0
4.7 nF	F0	F0	F0	F0	F0
6.8 nF	F0	F0	F0	F0	F0
10 nF	F0	F0	F0	F0	F0
15 nF	F0	F0	F0	F0	F0
22 nF	F0	F0	F0	F0	F0
33 nF	F0	F0	F0	F0	F0
47 nF	F0	F0	F0	F0	F0
68 nF	F0	F0	F0	F0	F0
100 nF	F0	F0	F0	F0	F0
150 nF	F0	F0	F0	F0	FA
220 nF	F0	F0	F0	F0	FA
330 nF	F0	F0	F0	F0	F0
470 nF	F0	F0	F0	F0	FI
680 nF	FA	FA	FA	FA	FC
1.0 μF	FA	FA	FA	FA	FC
2.2 μF	FA	FA	FA	FA	FC
4.7 μF	FC	FC	FC	FC	FC
10 μF	FC	FC	FC	FC	
22 μF	FC	FC	FD		
47 μF					

**NOTE**

1. Values in shaded cells indicate thickness class in mm
2. Capacitance value of non E-6 series is on request
3. For product with 5% tolerance, please contact local sales force before ordering
4. Please contact local sales force for special ordering code before ordering

**CAPACITANCE RANGE & THICKNESS FOR X7R**

Table 5 Sizes from 1210 to 1812

CAP.	1210		16 V			50 V		1812
	6.3 V	10 V	16 V	25 V	50 V	50 V	50 V	
100 pF								
150 pF								
220 pF								
330 pF								
470 pF								
680 pF								
1.0 nF								
1.5 nF								
2.2 nF	G0	G0	G0	G0	G0	G0		
3.3 nF	G0	G0	G0	G0	G0	G0		
4.7 nF	G0	G0	G0	G0	G0	G0	JA	
6.8 nF	G0	G0	G0	G0	G0	G0	JA	
10 nF	G0	G0	G0	G0	G0	G0	JA	
15 nF	G0	G0	G0	G0	G0	G0	JA	
22 nF	G0	G0	G0	G0	G0	G0	JA	
33 nF	G0	G0	G0	G0	G0	G0	JA	
47 nF	G0	G0	G0	G0	G0	G0	JA	
68 nF	G0	G0	G0	G0	G0	G0	JA	
100 nF	G0	G0	G0	G0	G0	G0	JB	
150 nF	G0	G0	G0	G0	G0	G1	JB	
220 nF	G0	G0	G0	G0	G0	G1	JB	
330 nF	G0	G0	G0	G0	G0	G1	JB	
470 nF	G1	G1	G1	G1	G1	GA	JB	
680 nF	G1	G1	G1	G1	G1	GA	JC	
1.0 µF	GA	GA	GA	GA	GA	GA	JC	
2.2 µF	GB	GB	GB	GB	GB	GB		
4.7 µF	GB	GB	GB	GB	GB	GD		
10 µF	GB	GB	GB	GB	GB			
22 µF	GC	GC	GC	GC	GC			
47 µF	GC	GC						

**NOTE**

1. Values in shaded cells indicate thickness class in mm
2. Capacitance value of non E-6 series is on request
3. For product with 5% tolerance, please contact local sales force before ordering
4. Please contact local sales force for special ordering code before ordering

**THICKNESS CLASSES AND PACKING QUANTITY**

Table 6

SIZE CODE	THICKNESS CLASSIFICATION	TAPE WIDTH QUANTITY PER REEL	Ø180 MM / 7 INCH		Ø330 MM / 13 INCH		QUANTITY PER BULK CASE
			Paper	Blister	Paper	Blister	
0201	0.3 ±0.03 mm	8 mm	15,000	---	50,000	---	---
0402	0.5 ±0.05 mm	8 mm	10,000	---	50,000	---	50,000
0603	0.8 ±0.1 mm	8 mm	4,000	---	15,000	---	15,000
0805	0.6 ±0.1 mm	8 mm	4,000	---	20,000	---	10,000
	0.85 ±0.1 mm	8 mm	4,000	---	15,000	---	8,000
	1.25 ±0.2 mm	8 mm	---	3,000	---	10,000	5,000
1206	0.6 ±0.1 mm	8 mm	4,000	---	20,000	---	---
	0.85 ±0.1 mm	8 mm	4,000	---	15,000	---	---
	1.00 / 1.15 ±0.1 mm	8 mm	---	3,000	---	10,000	---
	1.25 ±0.2 mm	8 mm	---	3,000	---	10,000	---
	1.6 ±0.15 mm	8 mm	---	2,500	---	10,000	---
	1.6 ±0.2 mm	8 mm	---	2,000	---	8,000	---
1210	0.6 / 0.7 ±0.1 mm	8 mm	---	4,000	---	15,000	---
	0.85 ±0.1 mm	8 mm	---	4,000	---	10,000	---
	1.15 ±0.1 mm	8 mm	---	3,000	---	10,000	---
	1.15 ±0.15 mm	8 mm	---	3,000	---	10,000	---
	1.25 ±0.2 mm	8 mm	---	3,000	---	---	---
	1.5 ±0.1 mm	8 mm	---	2,000	---	---	---
	1.6 / 1.9 ±0.2 mm	8 mm	---	2,000	---	---	---
	2.0 ±0.2 mm	8 mm	---	2,000 1,000	---	---	---
1808	1.15 ±0.15 mm	12 mm	---	3,000	---	---	---
	1.25 ±0.2 mm	12 mm	---	3,000	---	---	---
	1.35 ±0.15 mm	12 mm	---	2,000	---	---	---
	1.5 ±0.1 mm	12 mm	---	2,000	---	---	---
	1.6 ±0.2 mm	12 mm	---	2,000	---	8,000	---
	2.0 ±0.2 mm	12 mm	---	2,000	---	---	---
1812	0.6 / 0.85 ±0.1 mm	12 mm	---	2,000	---	---	---
	1.15 ±0.1 mm	12 mm	---	1,000	---	---	---
	1.25 ±0.2 mm	12 mm	---	1,000	---	---	---
	1.5 ±0.1 mm	12 mm	---	1,000	---	---	---
	1.6 ±0.2 mm	12 mm	---	1,000	---	---	---
	2.0 ±0.2 mm	12 mm	---	1,000	---	---	---
	2.5 ±0.2 mm	12 mm	---	500	---	---	---



ELECTRICAL CHARACTERISTICS

**X7R DIELECTRIC CAPACITORS; NISN TERMINATIONS**

Unless otherwise specified, all test and measurements shall be made under standard atmospheric conditions for testing as given in 5.3 of IEC 60068-1:

- Temperature: 15 °C to 35 °C
- Relative humidity: 25% to 75%
- Air pressure: 86 kPa to 106 kPa

Before the measurements are made, the capacitor shall be stored at the measuring temperature for a time sufficient to allow the entire capacitor to reach this temperature.

The period as prescribed for recovery at the end of a test is normally sufficient for this purpose.

Table 7

DESCRIPTION								VALUE
Capacitance range								100 pF to 47 μF
Capacitance tolerance								±5%, ±10%, ±20%
Dissipation factor (D.F.)								
X7R		0201	0402	0603	0805	1206	1210	
≤10V	100pF to 10nF	100pF to 100nF	100pF to 1μF	150pF to 2.2μF	220pF to 2.2μF	2.2nF to 2.2μF	2.2nF to 2.2μF	≤5%
	100nF	220nF to 470nF	2.2μF to 4.7μF	4.7μF to 10μF	4.7μF to 22μF	4.7μF to 47μF	4.7μF to 47μF	≤10%
		1μF						≤12.5%
16V	100pF to 1.2nF	100pF to 22nF	100pF to 220nF	150pF to 470nF	220pF to 1μF	2.2nF to 1μF	2.2nF to 1μF	≤ 3.5%
	1.5nF to 10nF	27nF to 100nF	470nF to 1.0μF	680 nF to 2.2μF	2.2μF	2.2μF to 10μF	2.2μF to 10μF	≤ 5%
		220nF	2.2μF	4.7μF to 10μF	4.7μF to 22μF	22μF	22μF	≤10%
25V	100pF to 470pF	100pF to 10nF	100pF to 39nF	150pF to 180nF	220pF to 680nF	2.2nF to 1μF	2.2nF to 1μF	≤ 2.5%
		12 nF to 47nF	47nF to 220nF	220nF to 470nF	1μF			≤ 3.5%
	560pF to 10nF	56nF to 100nF		680nF to 1μF	2.2μF	2.2μF	2.2μF	≤ 5%
			270nF to 1μF	2.2μF to 4.7μF	4.7μF to 22μF	4.7μF to 22μF	4.7μF to 22μF	≤10%
50V	100pF to 1nF	100pF to 10nF	100pF to 39nF	150pF to 180nF	220pF to 470nF	2.2nF to 1μF	2.2nF to 1μF	≤2.5%
		12 nF to 47nF	47nF to 220nF	220nF to 470nF	680nF to 1μF			≤ 3.5%
				680nF				≤ 5%
		100nF	470nF to 1μF	1μF to 2.2μF	2.2μF to 4.7μF	2.2μF to 10μF	2.2μF to 10μF	≤10%
Insulation resistance after 1 minute at U <sub>r</sub> (DC)								$R_{ins} \geq 10 G\Omega$ or $R_{ins} \times C_r \geq 500(100)^*$ seconds whichever is less
Maximum capacitance change as a function of temperature (temperature characteristic/coefficient):								±15%
Operating temperature range:								-55 °C to +125 °C

**NOTE**

\* For individual I.R specification, please contact local sales.

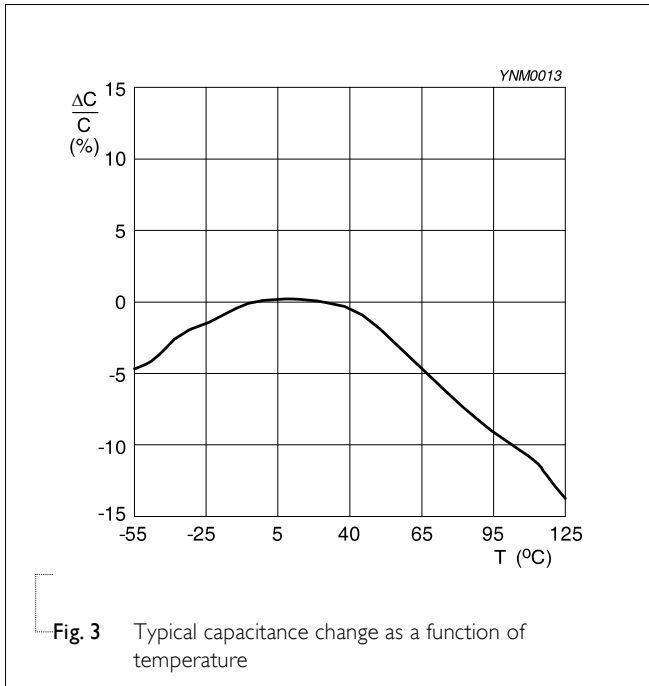

Size 0201 10 nF / 16 V  
Solid lines: Impedance / Dotted lines: ESR

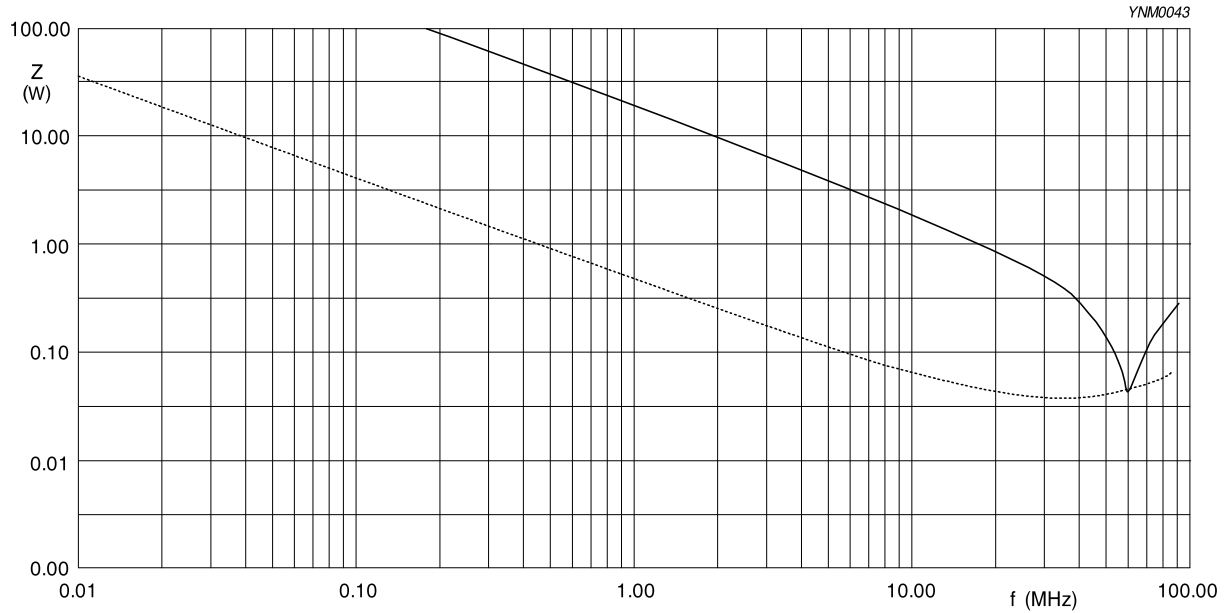

**Fig. 4** Impedance ESR vs. frequency characteristics for multilayer chip capacitors

Size 0402 100 nF / 16 V  
Solid lines: Impedance / Dotted lines: ESR

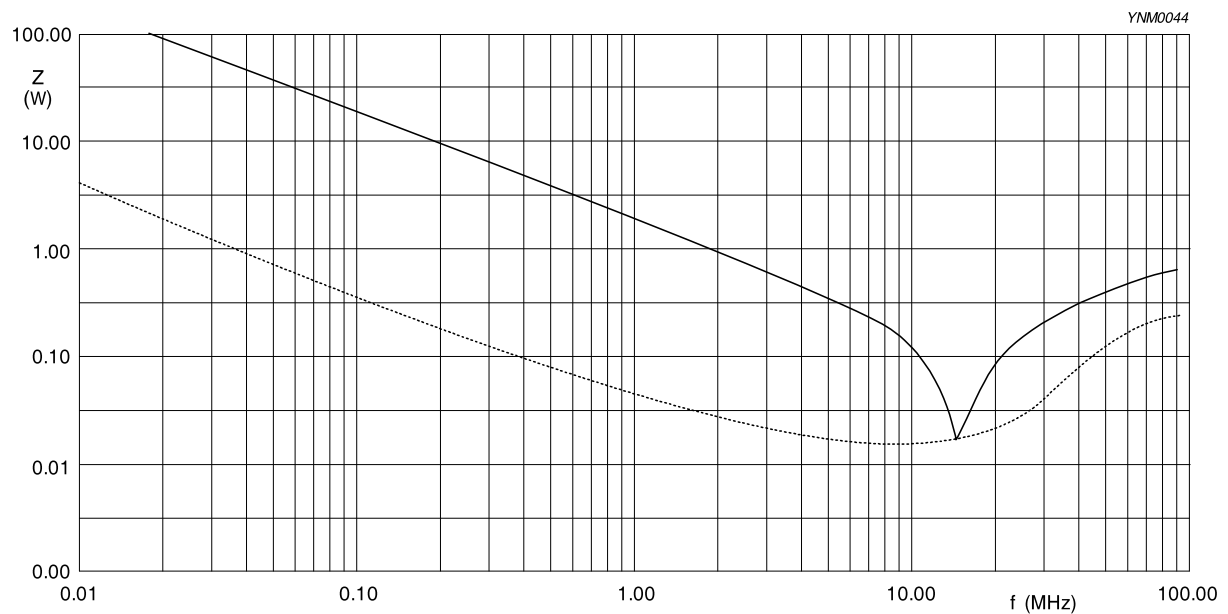

**Fig. 5** Impedance ESR vs. frequency characteristics for multilayer chip capacitors

Size 0603 1  $\mu$ F / 16 V  
Solid lines: Impedance / Dotted lines: ESR

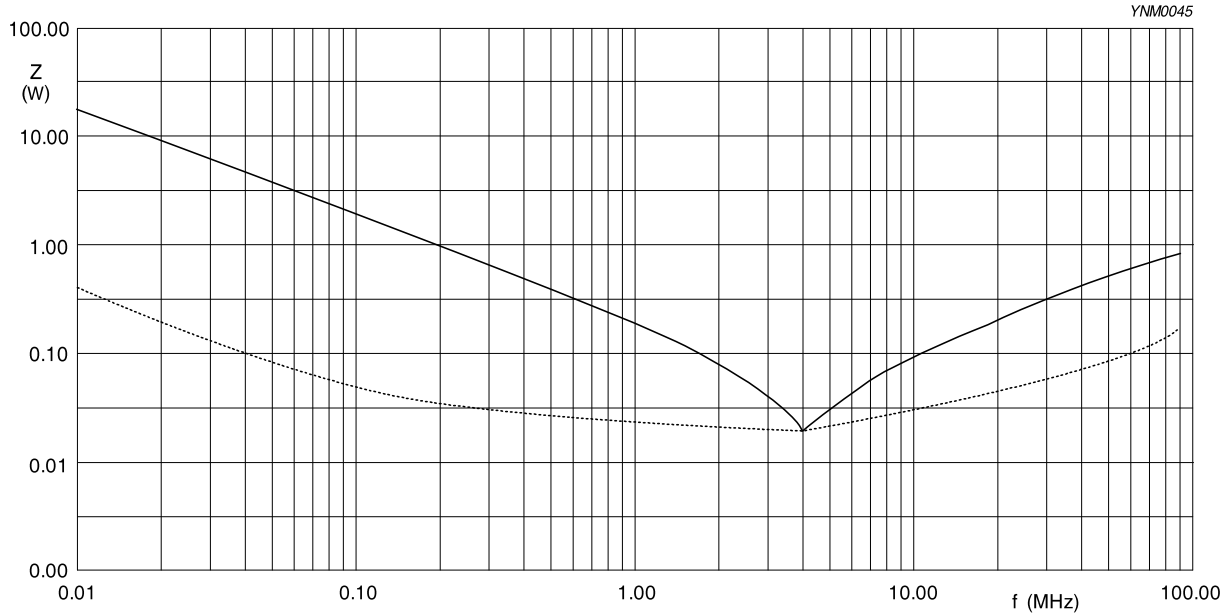

**Fig. 6** Impedance ESR vs. frequency characteristics for multilayer chip capacitors

Size 0805 1  $\mu$ F / 16 V  
Solid lines: Impedance / Dotted lines: ESR

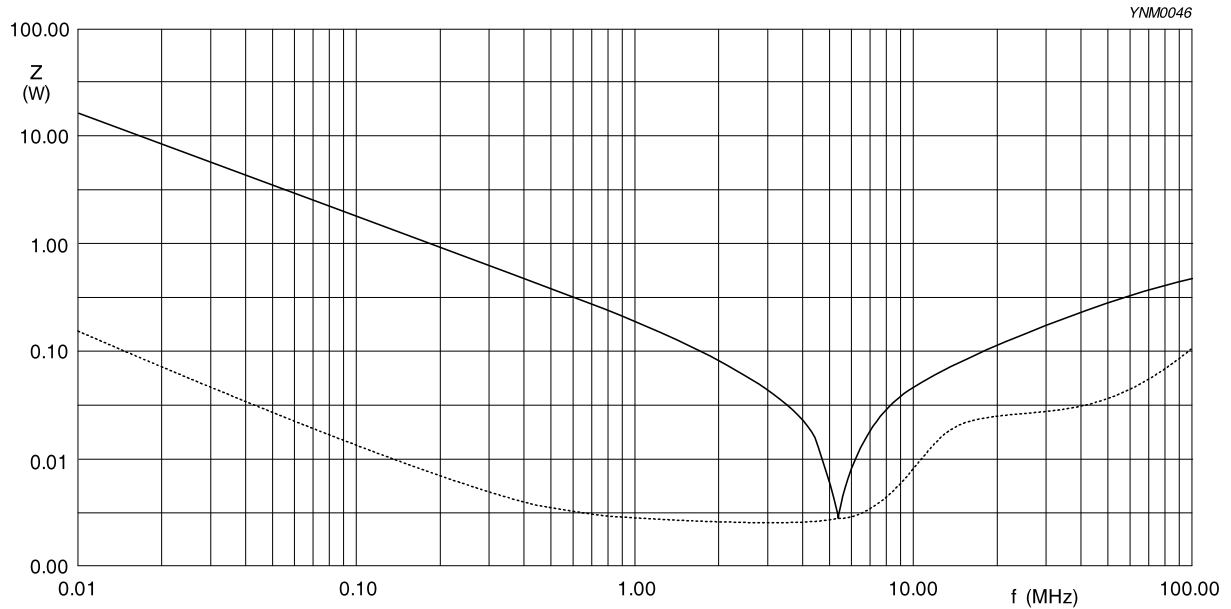

**Fig. 7** Impedance ESR vs. frequency characteristics for multilayer chip capacitors

Size 1206 1  $\mu$ F / 25 V  
Solid lines: Impedance / Dotted lines: ESR

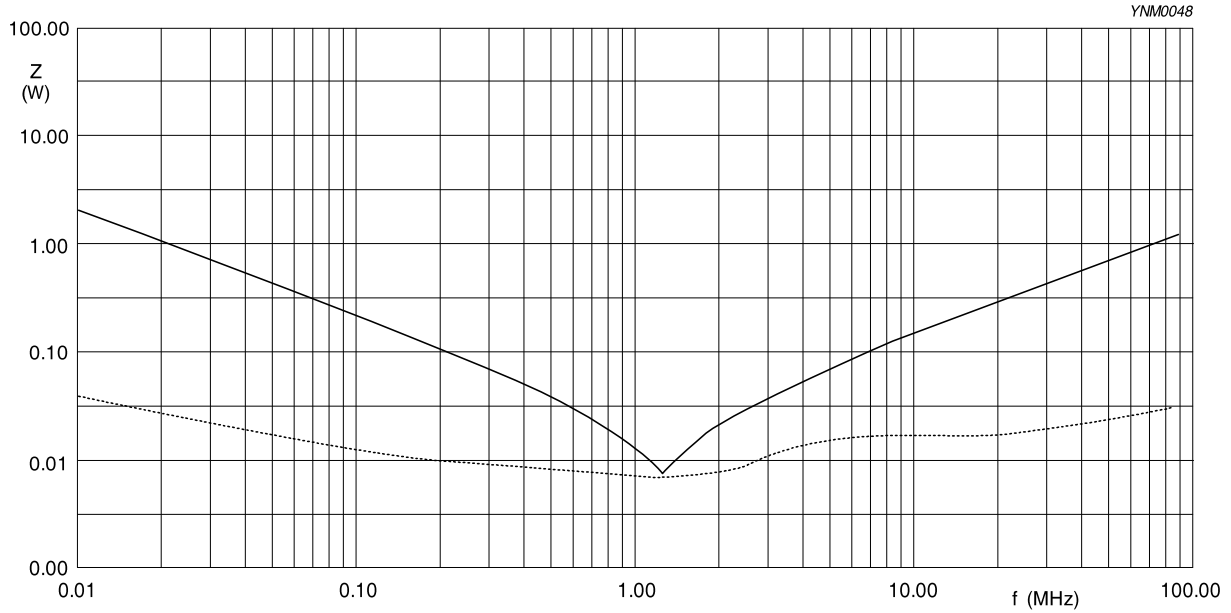

**Fig. 8** Impedance ESR vs. frequency characteristics for multilayer chip capacitors

Size 1206 10  $\mu$ F / 10 V  
Solid lines: Impedance / Dotted lines: ESR

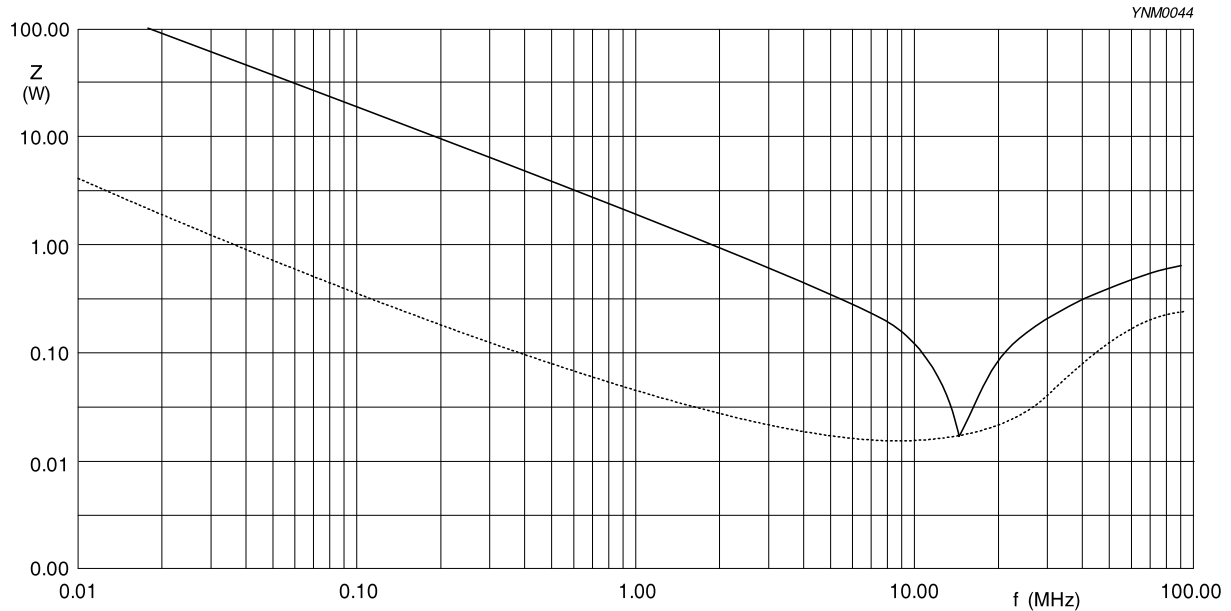

**Fig. 9** Impedance ESR vs. frequency characteristics for multilayer chip capacitors

**SOLDERING RECOMMENDATION**

Table 8

SOLDERING METHOD	SIZE					
	0201	0402	0603	0805	1206	≥ 1210
Reflow	Reflow only	> 100 nF	> 1 μF	> 2.2 μF	> 4.7 μF	Reflow only
Reflow/Wave		≤ 100 nF	≤ 1 μF	≤ 2.2 μF	≤ 4.7 μF	---

**TESTS AND REQUIREMENTS**

Table 9 Test procedures and requirements

TEST	TEST METHOD	PROCEDURE	REQUIREMENTS
Mounting	IEC 60384-21/22	4.3 The capacitors may be mounted on printed-circuit boards or ceramic substrates	No visible damage
Visual Inspection and Dimension Check	4.4	Any applicable method using × 10 magnification	In accordance with specification
Capacitance <sup>(1)</sup>	4.5.1	Class 2: At 20 °C, 24 hrs after annealing f = 1 KHz for C ≤ 10 μF, rated voltage > 6.3 V, measuring at voltage 1 V <sub>rms</sub> at 20 °C f = 1 KHz, for C ≤ 10 μF, rated voltage ≤ 6.3 V, measuring at voltage 0.5 V <sub>rms</sub> at 20 °C f = 120 Hz for C > 10 μF, measuring at voltage 0.5 V <sub>rms</sub> at 20 °C	Within specified tolerance
Dissipation Factor (D.F.) <sup>(1)</sup>	4.5.2	Class 2: At 20 °C, 24 hrs after annealing f = 1 KHz for C ≤ 10 μF, rated voltage > 6.3 V, measuring at voltage 1 V <sub>rms</sub> at 20 °C f = 1 KHz, for C ≤ 10 μF, rated voltage ≤ 6.3 V, measuring at voltage 0.5 V <sub>rms</sub> at 20 °C f = 120 Hz for C > 10 μF, measuring at voltage 0.5 V <sub>rms</sub> at 20 °C	In accordance with specification
Insulation Resistance	4.5.3	At U <sub>r</sub> (DC) for 1 minute	In accordance with specification

**NOTE:**

1. For individual product specification, please contact local sales.

TEST	TEST METHOD	PROCEDURE	REQUIREMENTS												
Temperature Characteristic	IEC 60384- 21/22 4.6	<p>Capacitance shall be measured by the steps shown in the following table.</p> <p>The capacitance change should be measured after 5 min at each specified temperature stage.</p> <table border="1"> <thead> <tr> <th>Step</th> <th>Temperature(°C)</th> </tr> </thead> <tbody> <tr> <td>a</td> <td>25±2</td> </tr> <tr> <td>b</td> <td>Lower temperature±3°C</td> </tr> <tr> <td>c</td> <td>25±2</td> </tr> <tr> <td>d</td> <td>Upper Temperature±2°C</td> </tr> <tr> <td>e</td> <td>25±2</td> </tr> </tbody> </table> <p>(1) Class I</p> <p>Temperature Coefficient shall be calculated from the formula as below</p> $\text{Temp. Coefficient} = \frac{C2 - C1}{C1 \times \Delta T} \times 10^6 \text{ [ppm/°C]}$ <p>C1: Capacitance at step c C2: Capacitance at 125°C ΔT: 100°C(=125°C-25°C)</p> <p>(2) Class II</p> <p>Capacitance Change shall be calculated from the formula as below</p> $\Delta C = \frac{C2 - C1}{C1} \times 100\%$ <p>C1: Capacitance at step c C2: Capacitance at step b or d</p>	Step	Temperature(°C)	a	25±2	b	Lower temperature±3°C	c	25±2	d	Upper Temperature±2°C	e	25±2	<p>&lt;General purpose series&gt;</p> <p>Class1: Δ C/C: ±30ppm</p> <p>Class2: X7R: Δ C/C: ±15% Y5V: Δ C/C: 22~-82%</p> <p>&lt;High Capacitance series&gt;</p> <p>Class2: X7R/X5R: Δ C/C: ±15% Y5V: Δ C/C: 22~-82%</p>
Step	Temperature(°C)														
a	25±2														
b	Lower temperature±3°C														
c	25±2														
d	Upper Temperature±2°C														
e	25±2														
Adhesion	4.7	<p>A force applied for 10 seconds to the line joining the terminations and in a plane parallel to the substrate</p>	<p>Force</p> <p>size ≥ 0603: 5N size = 0402: 2.5N size = 0201: 1N</p>												

TEST	TEST METHOD	PROCEDURE	REQUIREMENTS
------	-------------	-----------	--------------

Bond Strength	4.8	Mounting in accordance with IEC 60384-22 paragraph 4.3	No visible damage
---------------	-----	--	-------------------

Conditions: bending 1 mm at a rate of 1 mm/s, radius jig 5 mm

Test Substrate:

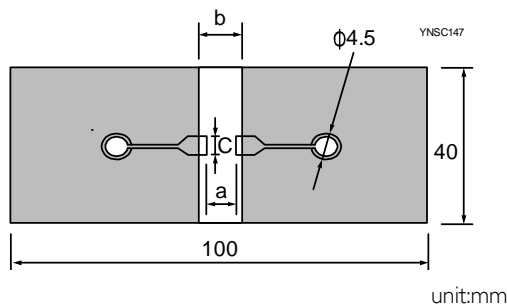

$\Delta C/C$   
Class2:  
X7R:  $\pm 10\%$

Type	Dimension(mm)		
	a	b	c
0201	0.3	0.9	0.3
0402	0.4	1.5	0.5
0603	1.0	3.0	1.2
0805	1.2	4.0	1.65
1206	2.2	5.0	1.65
1210	2.2	5.0	2.0
1808	3.5	7.0	3.7

Resistance to Soldering Heat	4.9	Precondition: 150 $\pm 0/-10$ °C for 1 hour, then keep for 24 $\pm 1$ hours at room temperature Preheating: for size $\leq$ 1206: 120 °C to 150 °C for 1 minute Preheating: for size $>$ 1206: 100 °C to 120 °C for 1 minute and 170 °C to 200 °C for 1 minute Solder bath temperature: 260 $\pm 5$ °C Dipping time: 10 $\pm 0.5$ seconds Recovery time: 24 $\pm 2$ hours	Dissolution of the end face plating shall not exceed 25% of the length of the edge concerned  $\Delta C/C$ Class2: X7R: $\pm 10\%$
------------------------------	-----	--	--

D.F. within initial specified value  
 $R_{ins}$  within initial specified value



TEST	TEST METHOD	PROCEDURE	REQUIREMENTS
Solderability	IEC 60384-21/22	4.10 Preheated to a temperature of 80 °C to 140 °C and maintained for 30 seconds to 60 seconds.	The solder should cover over 95% of the critical area of each termination
		<p>Test conditions for lead containing solder alloy</p> <p>Temperature: 235 ±5 °C                      Dipping time: 2 ±0.2 seconds                      Depth of immersion: 10 mm                      Alloy Composition: 60/40 Sn/Pb                      Number of immersions: 1</p> <p>Test conditions for lead-free containing solder alloy</p> <p>Temperature: 245 ±5 °C                      Dipping time: 3 ±0.3 seconds                      Depth of immersion: 10 mm                      Alloy Composition: SAC305                      Number of immersions: 1</p>	
Rapid Change of Temperature	4.11	<p>Preconditioning:                      150 +0/-10 °C for 1 hour, then keep for 24 ±1 hours at room temperature</p> <p>5 cycles with following detail:                      30 minutes at lower category temperature                      30 minutes at upper category temperature</p> <p>Recovery time 24 ±2 hours</p>	<p>No visual damage</p> <hr/> <p><math>\Delta C/C</math>                      Class2:                      X7R: ±15%</p> <hr/> <p>D.F. meet initial specified value  <math>R_{ins}</math> meet initial specified value</p>

TEST	TEST METHOD	PROCEDURE	REQUIREMENTS
Damp Heat with $U_r$ Load	IEC 60384-21/22 4.13	<ol style="list-style-type: none"> <li>Preconditioning, class 2 only: 150 <math>\pm</math>0/-10 °C /1 hour, then keep for 24 <math>\pm</math>1 hour at room temp</li> <li>Initial measure: Spec: refer to initial spec C, D, IR</li> <li>Damp heat test: 500 <math>\pm</math>12 hours at 40 <math>\pm</math>2 °C; 90 to 95% R.H. 1.0 <math>U_r</math> applied</li> <li>Recovery: Class 2: 24 <math>\pm</math>2 hours</li> <li>Final measure: C, D, IR</li> </ol> <p>P.S. If the capacitance value is less than the minimum value permitted, then after the other measurements have been made the capacitor shall be preconditioned according to "IEC 60384 4.1" and then the requirement shall be met.</p>	<p>No visual damage after recovery</p> <hr/> <p>&lt;General Purpose series&gt;</p> <p><math>\Delta C/C</math> Class2: X7R: <math>\pm</math>15% D.F. Class2: X7R: <math>\leq</math> 16V: <math>\leq</math> 7% <math>\geq</math> 25V: <math>\leq</math> 5%</p> <p><math>R_{ins}</math> Class2: X7R: <math>\geq</math> 500 M<math>\Omega</math> or <math>R_{ins} \times C_r \geq</math> 25s whichever is less</p> <p>&lt;High Capacitance series(<math>\geq</math> 1uF) and CC0402xRX7R9BB104&gt;</p> <p><math>\Delta C/C</math> Class2: X7R: <math>\pm</math>20% D.F. Class2: X7R: 2 x initial value max</p> <p><math>R_{ins}</math> Class2: X7R: 500 M<math>\Omega</math> or <math>R_{ins} \times C_r \geq</math> 5s whichever is less</p>

TEST	TEST METHOD	PROCEDURE	REQUIREMENTS
Endurance	IEC 60384- 4.14 21/22	1. Preconditioning, class 2 only: 150 +0/-10 °C /1 hour, then keep for 24 ±1 hour at room temp  2. Initial measure: Spec: refer to initial spec C, D, IR  3. Endurance test: Temperature: X7R: 125 °C Specified stress voltage applied for 1,000 hours: Applied 2.0 × U <sub>r</sub> for general products* Applied 1.5 × U <sub>r</sub> for high cap. Products*  4. Recovery time: 24 ±2 hours  5. Final measure: C, D, IR  P.S. If the capacitance value is less than the minimum value permitted, then after the other measurements have been made the capacitor shall be preconditioned according to "IEC 60384 4.1" and then the requirement shall be met.  * General product: 0201 ≤ 10nF, 0402 ≤ 100nF, 0603 ≤ 470nF, 0805, 1206, 1210 ≤ 1uF; * High cap product: 0201 > 10nF, 0402 > 100nF, 0603 > 470nF, 0805, 1206, 1210 > 1uF;	No visual damage  <General Purpose series> ΔC/C Class2: X7R: ±15% D.F. Class2: X7R: ≤ 16V: ≤ 7% ≥ 25V: ≤ 5%  R <sub>ins</sub> Class2: X7R: ≥ 1,000 MΩ or R <sub>ins</sub> × C <sub>r</sub> ≥ 50s whichever is less  <High Capacitance series> ΔC/C Class 2: X7R: ±20% D.F. Class 2: X7R: 2 × initial value max  R <sub>ins</sub> Class 2: X7R: 1,000 MΩ or R <sub>ins</sub> × C <sub>r</sub> ≥ 10s whichever is less
		Voltage Proof	IEC 60384- 4.6 1

**REVISION HISTORY**

REVISION	DATE	CHANGE NOTIFICATION	DESCRIPTION
Version 16	Dec 7th, 2016	-	- Dimension updated
Version 15	Oct. 3rd, 2016	-	- Dimension updated, Soldering recommendation updated
Version 14	May 31st, 2016	-	- Dimension updated
Version 13	Dec. 30, 2015	-	- Dimension on 0603 and 1206 case size updated
Version 12	May 26, 2015	-	- 1210, 25V dissipation factor updated
Version 11	Jan. 06, 2015	-	- 0402, 100nF, 50V Dissipation factor (D.F.) updated.
Version 10	Jul. 08, 2014	-	- Dimension updated
Version 9	Aug. 19, 2013	-	- Dimension updated
Version 8	Oct 13, 2011	-	- Dimension updated - 50V Dissipation factor(D.F) updated
Version 7	Jan 13, 2011	-	- Dimension updated
Version 6	Oct 13, 2010	-	- Rated voltage of 0201 extend to 50 V - Capacitance range of 0201 X7R 6.3V to 16V extend to 100 pF - Capacitance range of 0805 X7R 10V extend to 10 μF - Capacitance range of 0805 X7R 50V extend to 1 μF - Capacitance range of 1210 X7R 10V extend to 22 μF - Figures of impedance ESR updated
Version 5	Jul 27, 2010	-	- Dimension on 0603 and 1206 case size updated - 16V to 25V Dissipation factor(D.F) updated
Version 4	Apr 21, 2010	-	- The statement of "Halogen Free" on the cover added - Dimension updated
Version 3	Oct 26, 2009	-	- Capacitance range of 0402 X7R 25 V extend to 100 nF - 16V Dissipation factor updated
Version 2	May 11, 2009	-	- Product range updated
Version 1	Apr 24, 2009	-	- Ordering code updated
Version 0	Apr 15, 2009	-	- New datasheet for general purpose and high capacitance X7R series with RoHS compliant - Replace the "6.3V to 50V" part of pdf files: X7R_10V_9, X7R_16V-to-100V_9, X7R_16-to-500V_9, UP-X5R_X7R_HighCaps_6.3-to-25V_11, UY-X5R_X7R_HighCaps_6.3-to-25V_11 - Combine 0201 from pdf files: UP-NP0X5RX7RY5V_0201_6.3-to-50V_2 and UY-NP0X5RX7RY5V_0201_6.3-to-50V_2 - Define global part number - Description of "Halogen Free compliant" added - Test method and procedure updated