

### Sidelooker Infrared LED IR908-7C



#### Features

- High reliability
- High radiant intensity
- Peak wavelength  $\lambda_p=940\text{nm}$
- 2.54mm lead spacing
- Low forward voltage
- Pb free
- This product itself will remain within RoHS compliant version
- Compliance with EU REACH
- Compliance Halogen Free (Br < 900ppm, Cl < 900ppm, Br+Cl < 1500ppm)

#### Description

- EVERLIGHT's Infrared emitting diode IR908-7C is a high intensity diode, molded in a water clear plastic package
- The miniature side-facing device has a chip, that emits radiation from the side of the clear package

#### Applications

- Mouse
- Optoelectronic switch
- Infrared applied system

#### Device Selection Guide

Part Category	Chip Material	Lens Color
IR	GaAlAs	Water Clear

Package Dimension

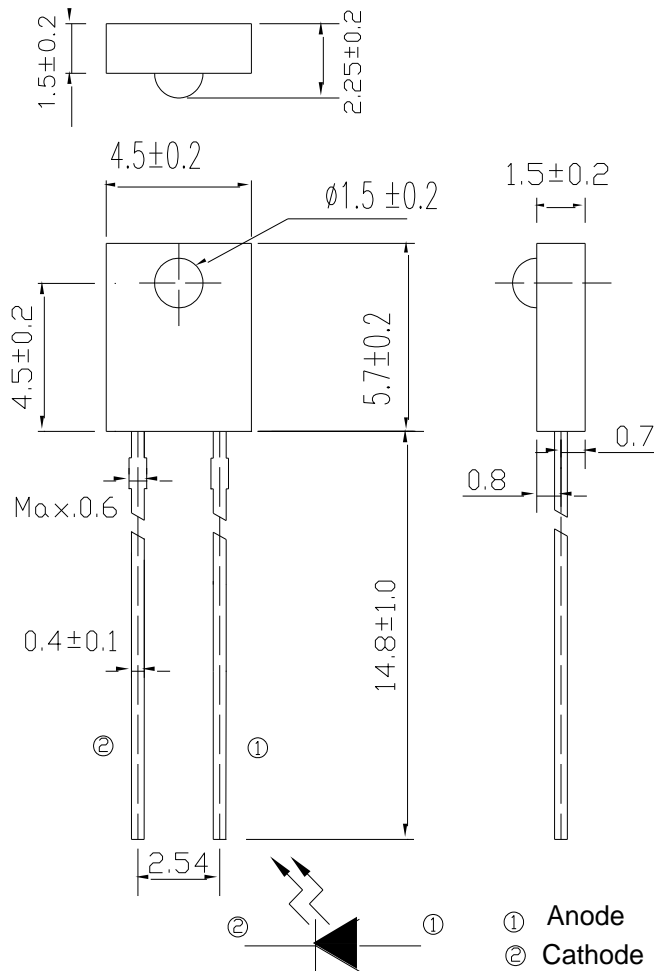

- Notes: 1. All dimensions are in millimeters.  
2. Tolerances unless dimensions  $\pm 0.3$  mm.  
3. Lead spacing is measured where the lead emerges from the package or under stopper.

Absolute Maximum Ratings ( $T_a=25^\circ\text{C}$ )

Parameter	Symbol	Rating	Unit
Continuous Forward Current	$I_F$	50	mA
Reverse Voltage	$V_R$	5	V
Operating Temperature	$T_{opr}$	-25 ~ +85	$^\circ\text{C}$
Storage Temperature	$T_{stg}$	-40 ~ +85	$^\circ\text{C}$
Soldering Temperature *1	$T_{sol}$	260	$^\circ\text{C}$
Power Dissipation at (or below) 25 $^\circ\text{C}$ Free Air Temperature	$P_d$	75	mW

Notes: \*1 Soldering time  $\leq 5$  seconds

**Electro-Optical Characteristics (Ta=25°C)**

Parameter	Symbol	Condition	Min.	Typ.	Max.	Units
Light Current	$I_{C(ON)}$	$I_F=4mA, V_{CE}=3.5V$	143	--	1274	$\mu A$
Peak Wavelength	$\lambda_p$	$I_F=20mA$	--	940	--	nm
Spectral Bandwidth	$\Delta\lambda$	$I_F=20mA$	--	50	--	nm
Forward Voltage	$V_F$	$I_F=20mA$	--	1.25	1.60	V
Reverse Current	$I_R$	$V_R=5V$	--	--	10	$\mu A$
View Angle	201/2	$I_F=20mA$	--	40	--	deg

**Rank**

Symbol	Condition	Ranks	Min.	Max.	Unit
$I_{C(ON)}$	$I_F=4mA$ $V_{CE}=3.5V$	E1	143	255	$\mu A$
		E2	214	343	
		E3	286	431	
		E4	357	519	
		E5	428	608	
		E6	500	696	
		E7	571	784	

**Rough Ranks**

Symbol	Condition	Ranks	Min.	Max.	Unit
$I_{C(ON)}$	$I_F=4mA$ $V_{CE}=3.5V$	7-2	306	441	$\mu A$
		7-1	347	550	
		6-2	465	750	
		6-1	650	1274	

**Notes:** This bin table is only for reference, not for specific bin shipment.

**Test Method For  $I_{C(ON)}$ :**

Condition:  $I_F=4mA, V_{CE}=3.5V$

The intensity testing method for infrared emitting diode

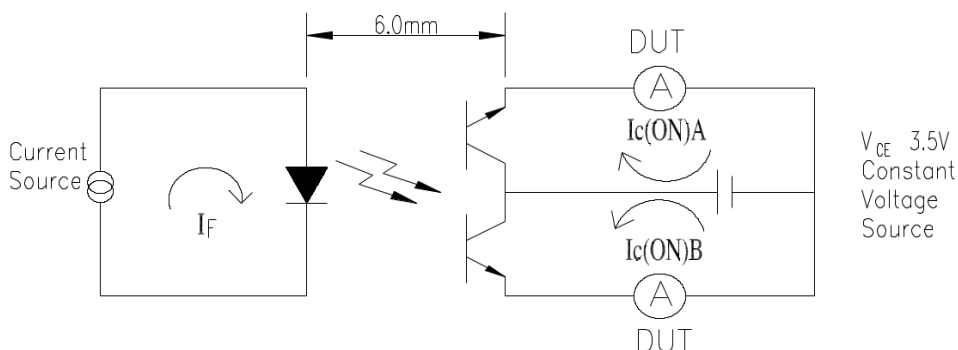

Typical Electro-Optical Characteristics Curves

Fig.1 Forward Current vs. Ambient Temperature

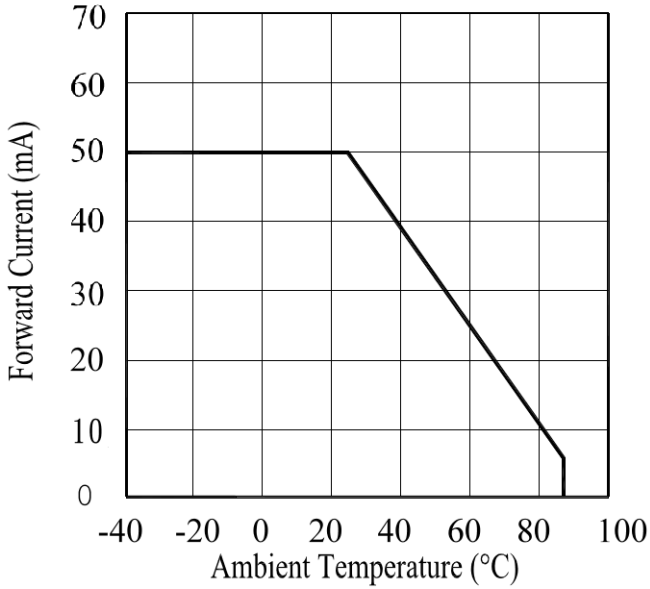

Fig.2 Spectral Distribution

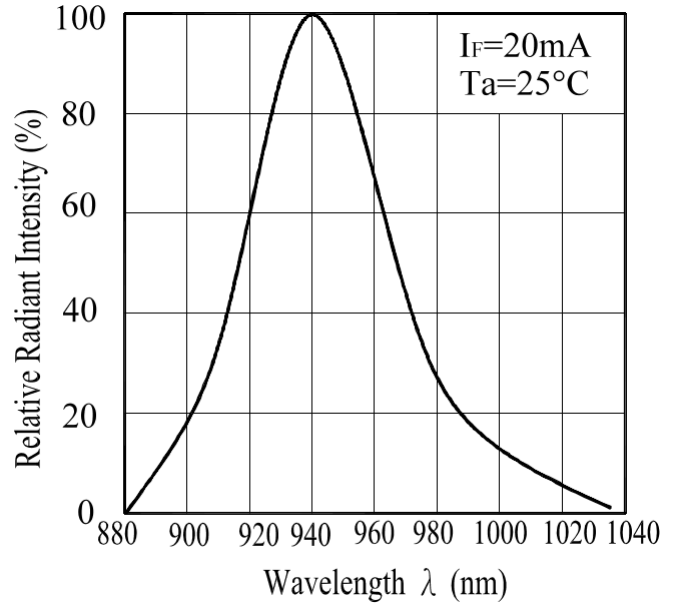

Fig.3 Forward Current vs. Forward Voltage

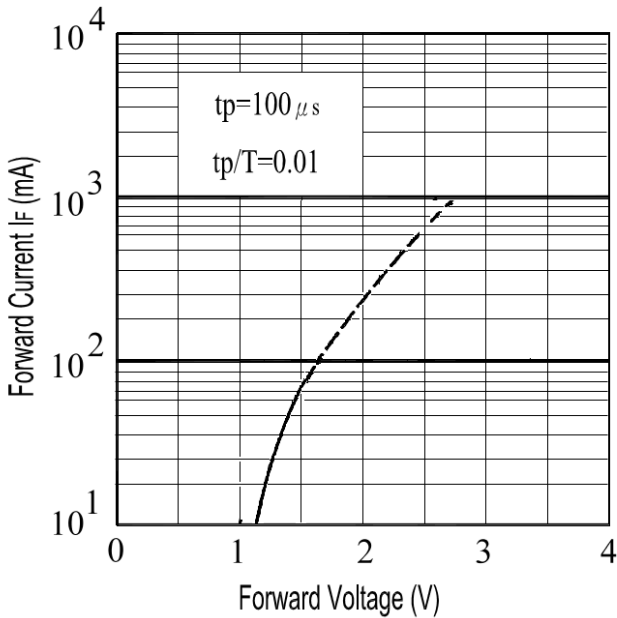
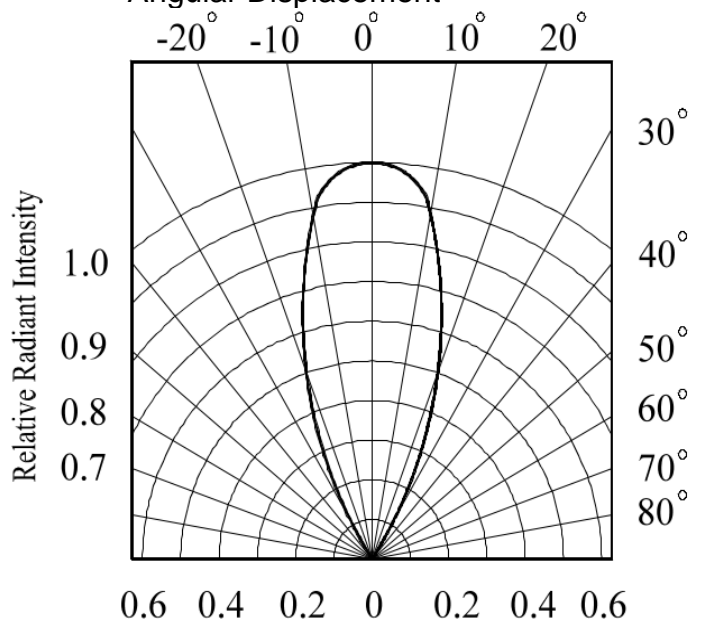

Fig. 4 Relative Radiant Intensity vs. Angular Displacement



### Packing Quantity Specification

1000 pcs/bag, 8 bags/box  
10 boxes/carton

### Label Form Specification

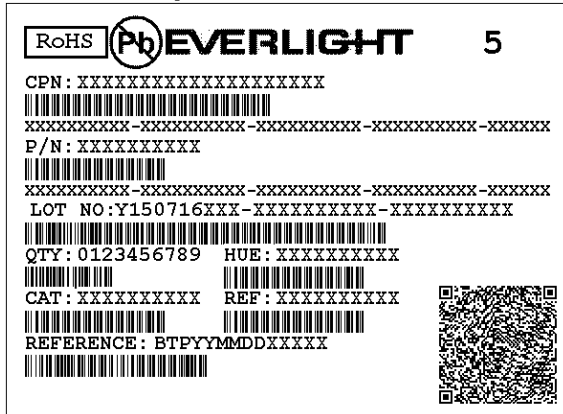

- CPN: Customer Part Number
- P/N: Part Number
- QTY: Packing Quantity
- CAT: Ranks
- REF: Reference
- LOT No: Lot Number

### Notes

#### Lead Forming

1. During lead frame bending, the lead frame should be bent at a distance more than 3mm from bottom of the epoxy.  
Note: Must fix lead frame and do not touch epoxy before bending to avoid LEDs broken.
2. Lead forming should be done before soldering.
3. Avoid stressing the LED package during leads forming. The stress to the base may damage the LED's characteristics or it may break the LEDs.
4. Cut the LED lead frame at room temperature. Cutting the lead frames at high temperatures may cause failure of the LEDs.
5. When mounting the LEDs onto a PCB, the PCB holes must be aligned exactly with the lead position of the LED. If the LEDs are mounted with stress at the leads, it causes deterioration of the epoxy resin and this will degrade the LEDs.

#### Storage

1. The LEDs should be stored at 10~30°C and 70%RH or less after being shipped from Everlight and the storage life limits are 3 months. If the LEDs are stored for 3 months or more, they can be stored at 10°C~25°C and 20%RH~60%RH for a year in a sealed container with a nitrogen atmosphere. After opening the package, the devices must be stored at 10°C~25°C and 20%RH~60%RH, and suggested to be used within 24 hours or as soon as possible. Besides, suggest that the remaining devices seal in the package bag as soon as possible please.
2. Please avoid rapid transitions in ambient temperature, especially in high humidity environments where condensation can occur.

### Soldering

- Careful attention should be paid during soldering. When soldering, leave more than 3mm from solder joint to epoxy bulb, and soldering beyond the base of the tie bar is recommended.
- Recommended soldering conditions:

Hand Soldering		DIP Soldering	
Temp. at tip of iron	300°C Max. (30W Max.)	Preheat temp.	100°C Max. (60 sec Max.)
Soldering time	3 sec Max.	Bath temp. & time	260 Max., 5 sec Max
Distance	3mm Min.(From solder joint to epoxy bulb)	Distance	3mm Min. (From solder joint to epoxy bulb)

- Recommended soldering profile

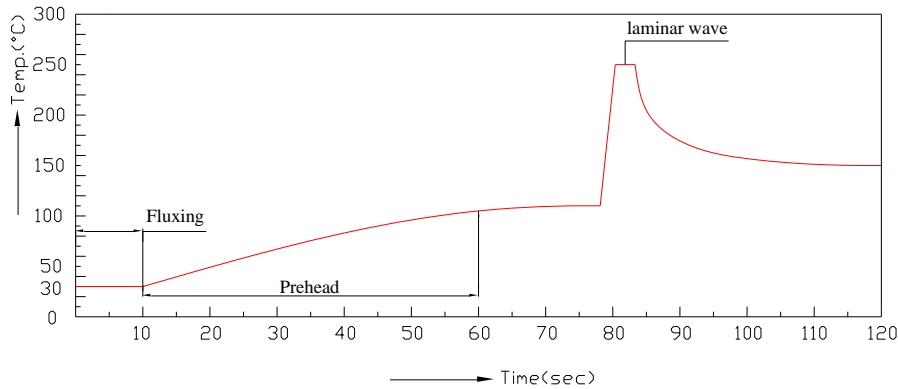

- Avoiding applying any stress to the lead frame while the LEDs are at high temperature particularly when soldering.
- Dip and hand soldering should not be done more than one time
- After soldering the LEDs, the epoxy bulb should be protected from mechanical shock or vibration until the LEDs return to room temperature.
- A rapid-rate process is not recommended for cooling the LEDs down from the peak temperature.
- Although the recommended soldering conditions are specified in the above table, dip or hand soldering at the lowest possible temperature is desirable for the LEDs.
- Wave soldering parameter must be set and maintain according to recommended temperature and dwell time in the solder wave.

### Cleaning

Do not clean the LEDs by the ultrasonic.

### Heat Management

- Heat management of LEDs must be taken into consideration during the design stage of LED application. The current should be de-rated appropriately by referring to the de-rating curve found in each product specification.
- The temperature surrounding the LED in the application should be controlled. Please refer to the data sheet de-rating curve.

### ESD (Electrostatic Discharge)

1. The products are sensitive to static electricity or surge voltage. ESD can damage a die and its reliability.
2. When handling the products, the following measures against electrostatic discharge are strongly recommended:
  - Eliminating the charge
  - Grounded wrist strap, ESD footwear, clothes and floors
  - Grounded workstation equipment and tools
  - ESD table/shelf mat made of conductive materials
3. Proper grounding is required for all devices, equipment, and machinery used in product assembly. Surge protection should be considered when designing of commercial products
4. If tools or equipment contain insulating materials such as glass or plastic, the following measures against electrostatic discharge are strongly recommended:
  - Dissipating static charge with conductive materials
  - Preventing charge generation with moisture
  - Neutralizing the charge with ionizers

### Directions for use

The LEDs should be operated with forward bias. The driving circuit must be designed so that the LEDs are not subjected to forward or reverse voltage while it is off. If reverse voltage is continuously applied to the LEDs, it may cause migration resulting in LED damage.

### DISCLAIMER

1. EVERLIGHT reserves the right(s) on the adjustment of product material mix for the specification.
2. The product meets EVERLIGHT published specification for a period of twelve (12) months from date of shipment.
3. The graphs shown in this datasheet are representing typical data only and do not show guaranteed values.
4. When using this product, please observe the absolute maximum ratings and the instructions for using outlined in these specification sheets. EVERLIGHT assumes no responsibility for any damage resulting from the use of the product which does not comply with the absolute maximum ratings and the instructions included in these specification sheets.
5. These specification sheets include materials protected under copyright of EVERLIGHT. Reproduction in any form is prohibited without obtaining EVERLIGHT's prior consent.
6. This product is not intended to be used for military, aircraft, automotive, medical, life sustaining or life saving applications or any other application which can result in human injury or death. Please contact authorized Everlight sales agent for special application request.