

### 4 TERMINAL 2A OUTPUT LOW DROP VOLTAGE REGULATOR

The KIA278R × × Series are Low Drop Voltage Regulator suitable for various electronic equipments. It provides constant voltage power source with TO-220-4 terminal lead full molded PKG. The Regulator has multi function such as over current protection, overheat protection and ON/OFF control.

#### FEATURES

- 2.0A Output Low Drop Voltage Regulator.
- Built in ON/OFF Control Terminal.
- Built in Over Current Protection, Over Heat Protection Function.

#### LINE UP

ITEM	OUTPUT VOLTAGE (Typ.)	UNIT
KIA278R05PI	5	V
KIA278R06PI	6	
KIA278R08PI	8	
KIA278R09PI	9	
KIA278R10PI	10	
KIA278R12PI	12	
KIA278R15PI	15	

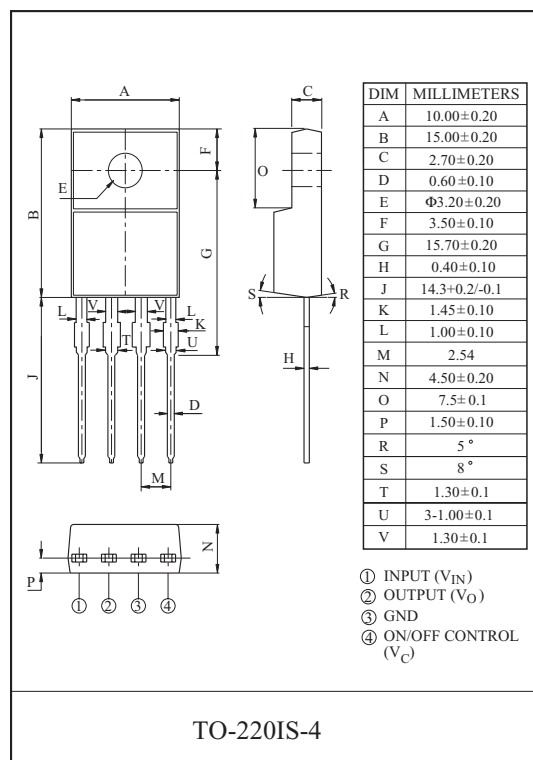

#### MAXIMUM RATINGS (T<sub>a</sub>=25 °C)

CHARACTERISTIC	SYMBOL	RATING	UNIT	Remark
Input Voltage	V <sub>IN</sub>	35	V	-
ON/OFF Control Voltage	V <sub>C</sub>	35	V	-
Output Current	I <sub>O</sub>	2	A	-
Power Dissipation 1	P <sub>d1</sub>	1.5	W	No heatsink
Power Dissipation 2	P <sub>d2</sub>	15	W	with heatsink
Operating Junction Temperature	T <sub>J(opr)</sub>	-40~150	°C	-
Storage Temperature	T <sub>stg</sub>	-45~150	°C	-
Soldering Temperature (10sec)	T <sub>sol</sub>	260	°C	-

# KIA278R05PI~KIA278R15PI

## ELECTRICAL CHARACTERISTICS

(Unless otherwise specified,  $I_O=1.0A$ ,  $T_a=25^\circ C$ , Note1.)

CHARACTERISTIC	SYMBOL	CONDITIONS	MIN.	TYP.	MAX.	UNIT
Output Voltage	KIA278R05	-	4.88	5.0	5.12	V
	KIA278R06	-	5.85	6.0	6.15	
	KIA278R08	-	7.80	8.0	8.2	
	KIA278R09	-	8.78	9.0	9.22	
	KIA278R10	-	9.75	10.0	10.25	
	KIA278R12	-	11.70	12.0	12.30	
	KIA278R15	-	14.70	15.0	15.30	
Load Regulation	Reg Load	$I_O=5mA \sim 2A$	-	0.1	2.0	%
Line Regulation	Reg Line	(Note 2)	-	0.5	2.5	%
Temperature Coefficient of Output Voltage	$T_C V_O$	$T_j=0 \sim 125^\circ C$	-	$\pm 0.02$	$\pm 0.05$	%/ $^\circ C$
Ripple Rejection	$R \cdot R$	-	45	55	-	dB
Drop Out Voltage	$V_D$	$I_O=2A$	-	-	0.5	V
Output ON state for control Voltage	$V_{C(ON)}$	-	2.0	-	-	V
Output ON state for control Current	$I_{C(ON)}$	$V_C=2.7V$	-	-	20	$\mu A$
Output OFF state for control Voltage	$V_{C(OFF)}$	-	-	-	0.8	V
Output OFF state for control Current	$I_{C(OFF)}$	$V_C=0.4V$	-	-	-0.4	mA
Quiescent Current	$I_Q$	$I_O=0$	-	-	10	mA

Note1)  $V_{IN}$  of KIA278R05=7V

Note2)  $V_{IN}$  of KIA278R05=6~12V

Note3) At  $V_{IN}=0.95V_O$

" KIA278R06=8V

" KIA278R06=7~15V

" KIA278R08=10V

" KIA278R08=9~25V

" KIA278R09=15V

" KIA278R09=10~25V

" KIA278R10=16V

" KIA278R10=11~26V

" KIA278R12=18V

" KIA278R12=13~29V

" KIA278R15=21V

" KIA278R15=16~32V

## BLOCK DIAGRAM

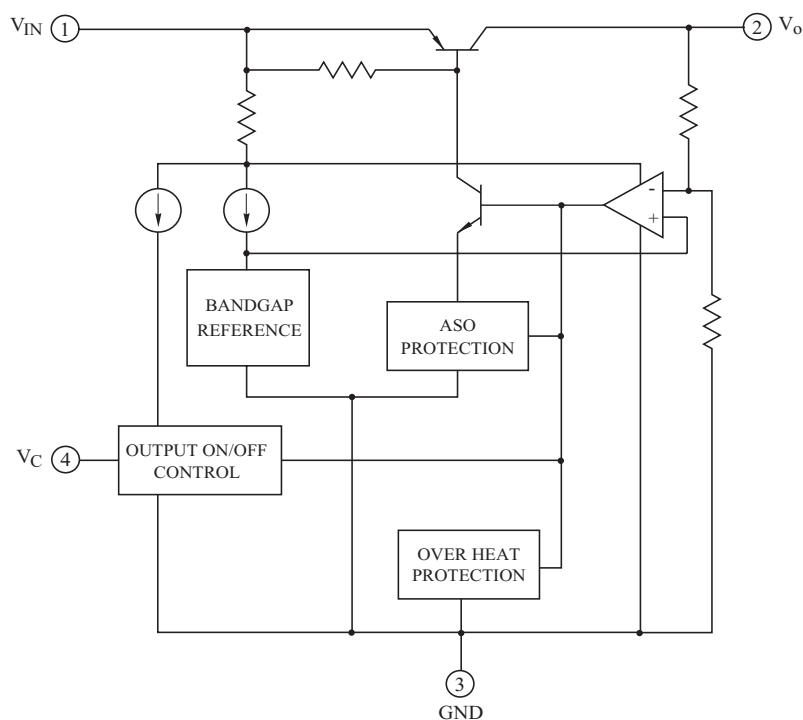

# KIA278R05PI~KIA278R15PI

Fig. 1 Standard Test Circuit

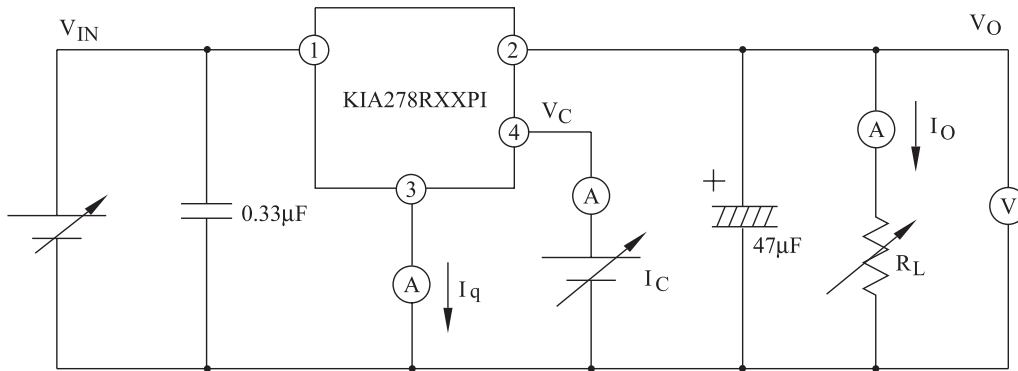

Fig. 1-2 Ripple Rejection Test Circuit

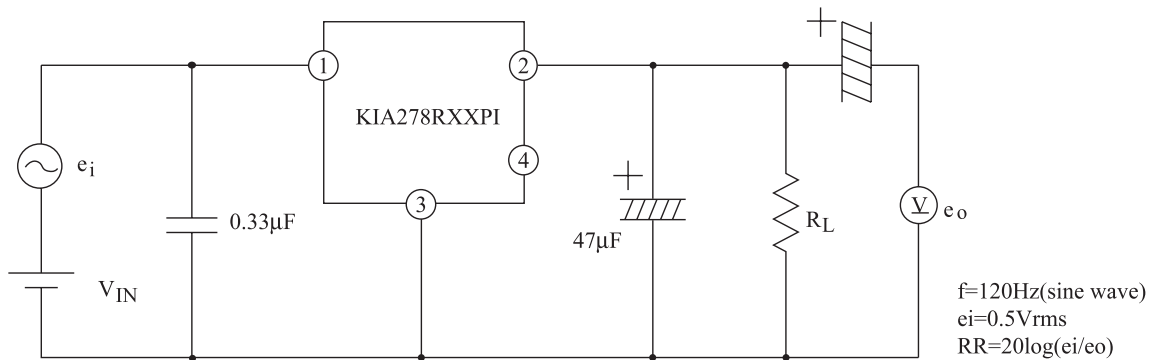
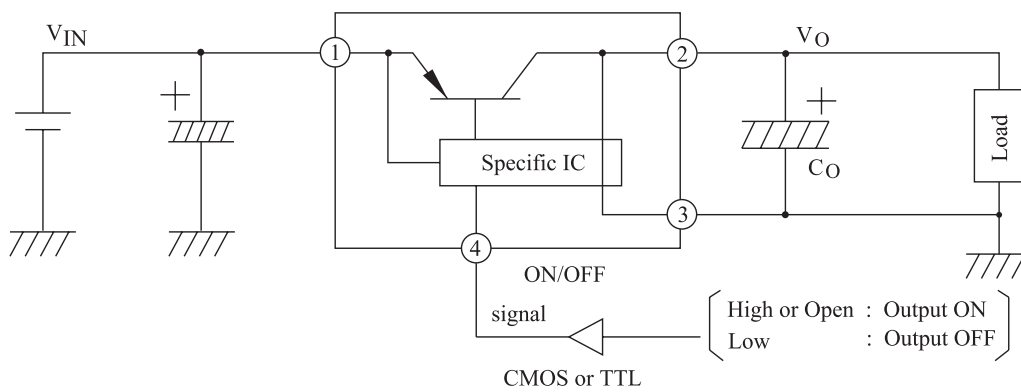
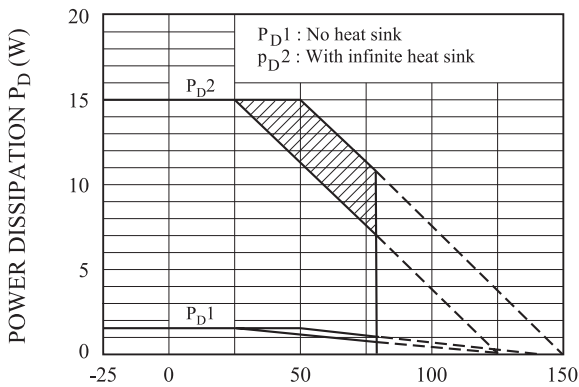

Fig. 2 Application Circuit for Standard



# KIA278R05PI~KIA278R15PI

Fig.3  $T_a - P_D$



AMBIENT TEMPERATURE  $T_a$  (°C)  
 Note) Oblique line portion : Overheat protection may operate in this area.

Fig.4  $I_O - V_O$

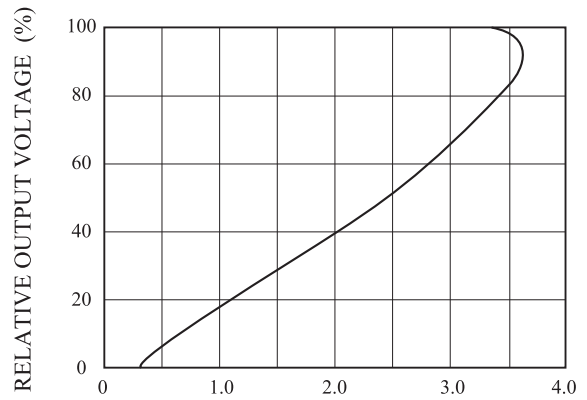

OUTPUT CURRENT  $I_O$  (A)

Fig.5-1  $T_j - \Delta V_O$  (KIA278R05)

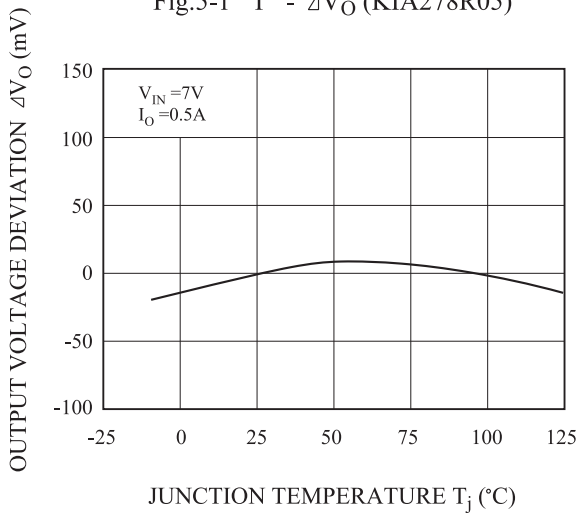

JUNCTION TEMPERATURE  $T_j$  (°C)

Fig.5-2  $T_j - \Delta V_O$  (KIA278R08)

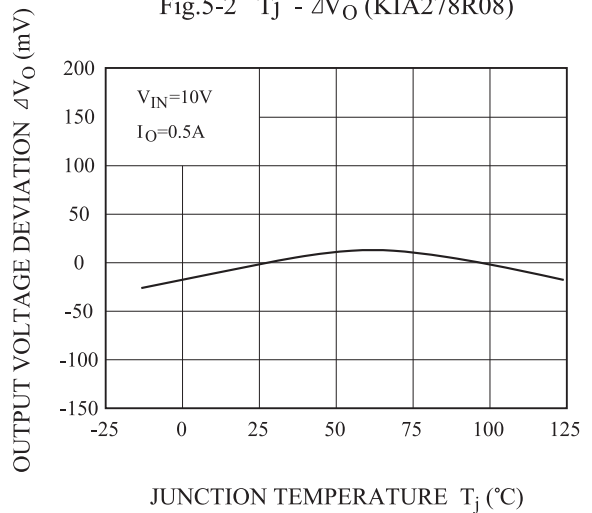

JUNCTION TEMPERATURE  $T_j$  (°C)

Fig.5-3  $T_j - \Delta V_O$  (KIA278R09)

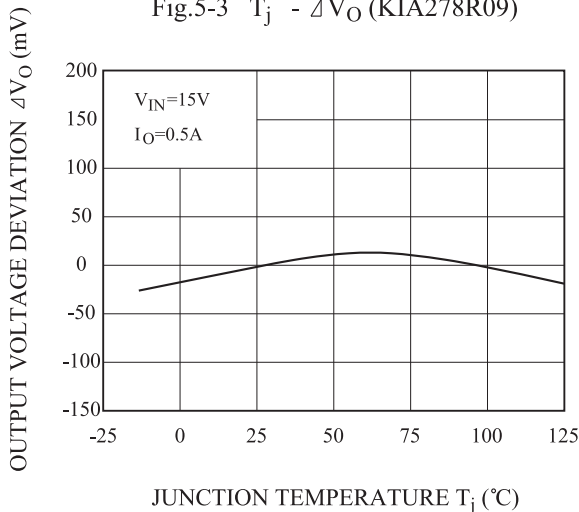

JUNCTION TEMPERATURE  $T_j$  (°C)

Fig.5-4  $T_j - \Delta V_O$  (KIA278R12)

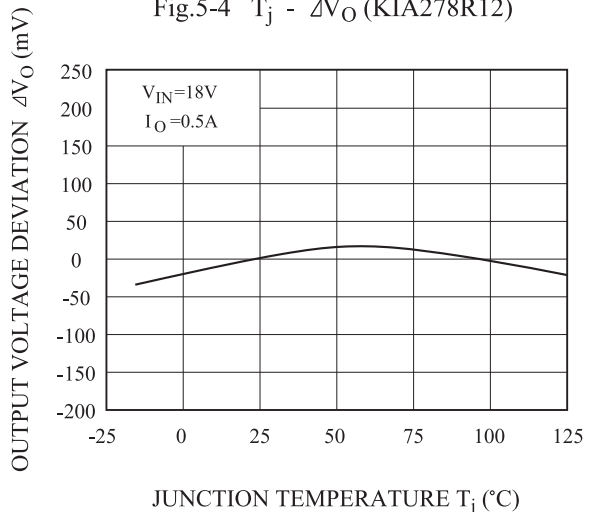

JUNCTION TEMPERATURE  $T_j$  (°C)

# KIA278R05PI~KIA278R15PI

Fig.5-5  $T_j - \Delta V_O$  (KIA278R15)

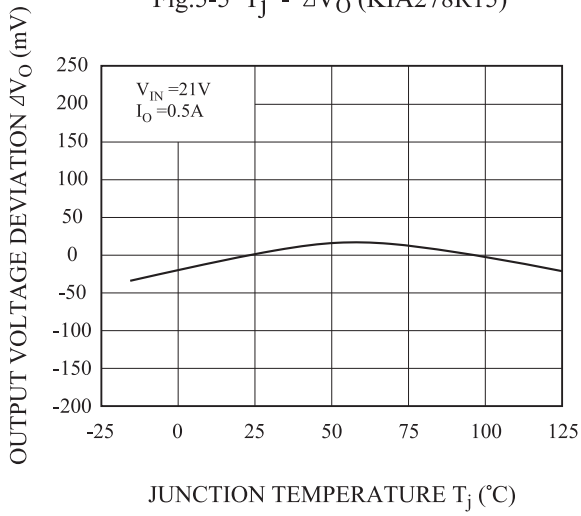

Fig.6-1  $T_j - V_O$  (KIA278R05)

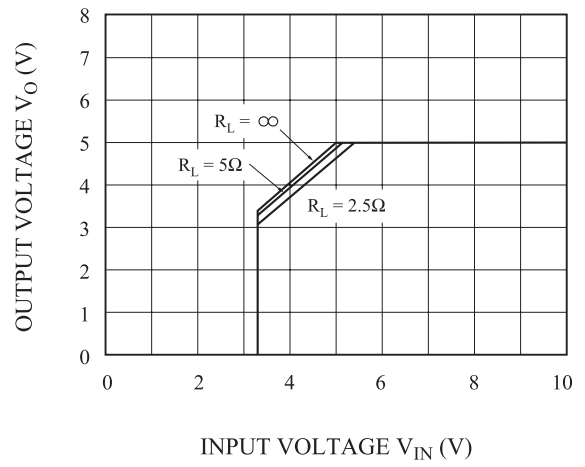

Fig.6-2  $V_{IN} - V_O$  (KIA278R08)

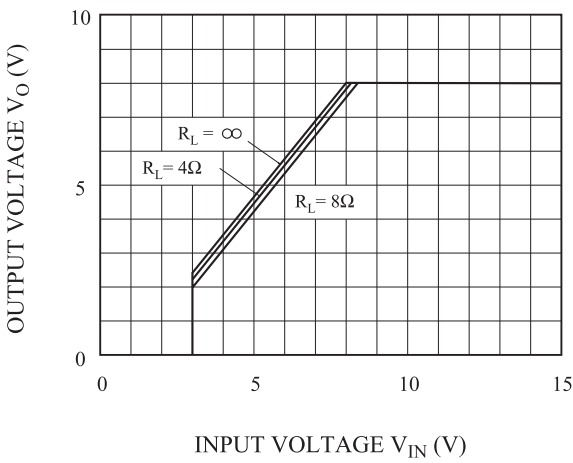

Fig.6-3  $V_{IN} - V_O$  (KIA278R09)

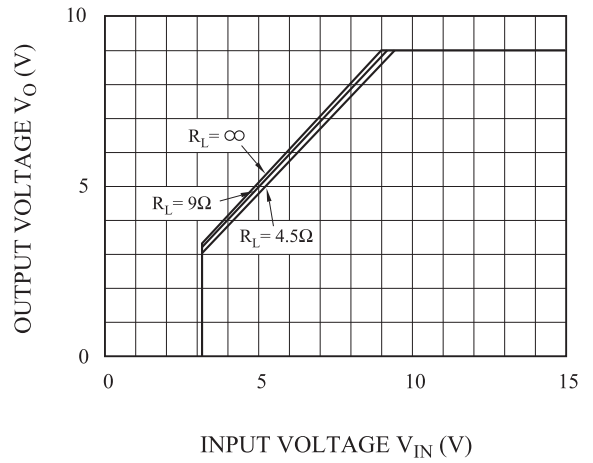

Fig.6-4  $V_{IN} - V_O$  (KIA278R12)

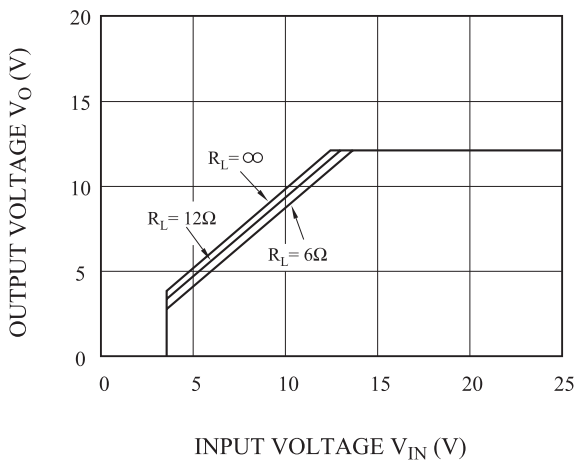
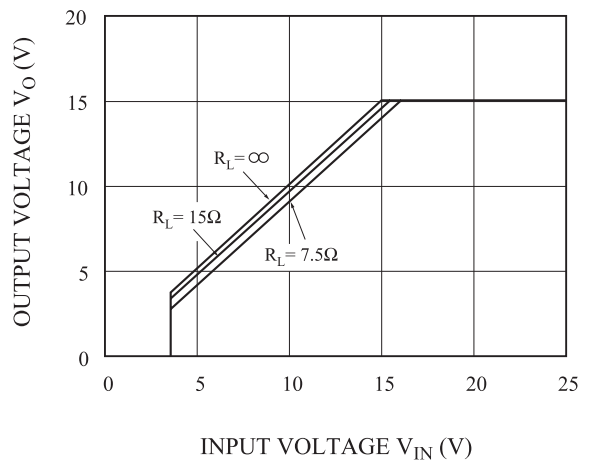
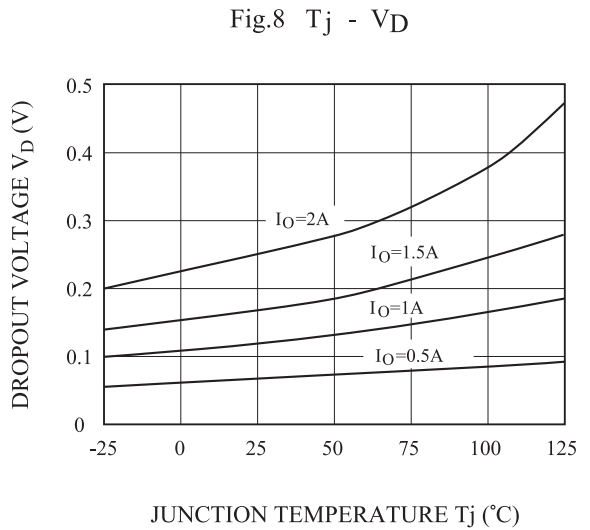
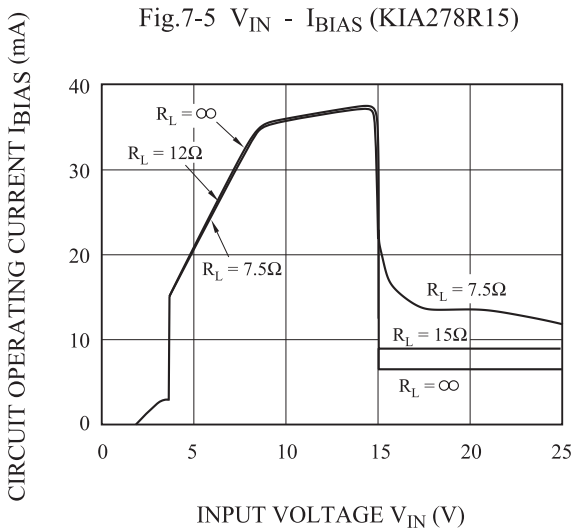
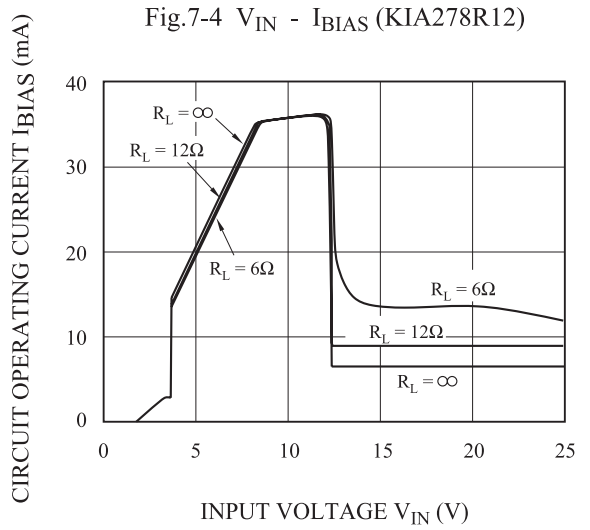
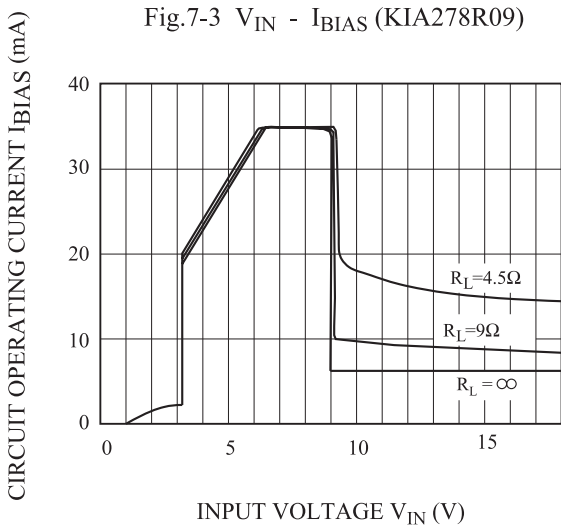
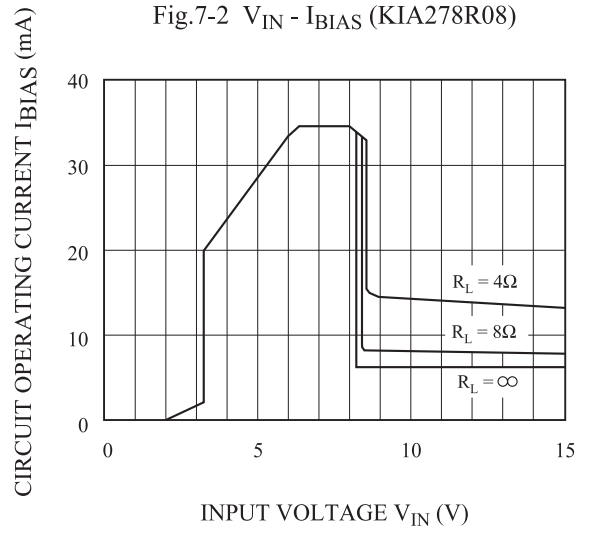
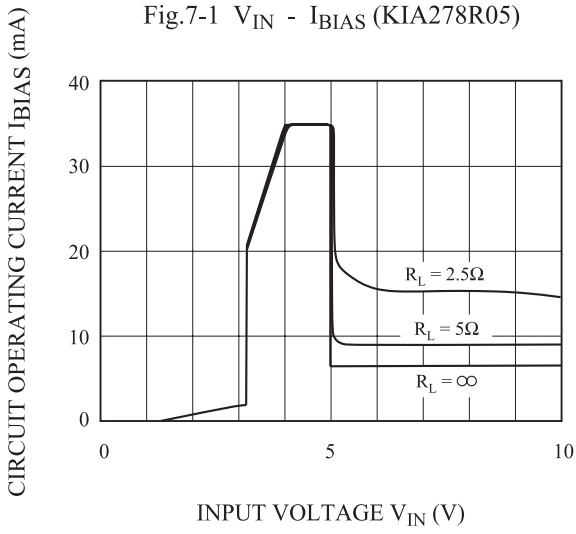

Fig.6-5  $V_{IN} - V_O$  (KIA278R15)



# KIA278R05PI~KIA278R15PI



# KIA278R05PI~KIA278R15PI

Fig.9  $T_j$  -  $I_q$

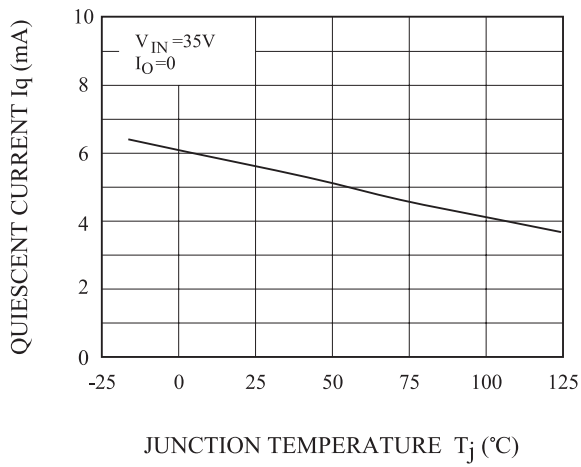

Fig. 10-1  $f$  - RR

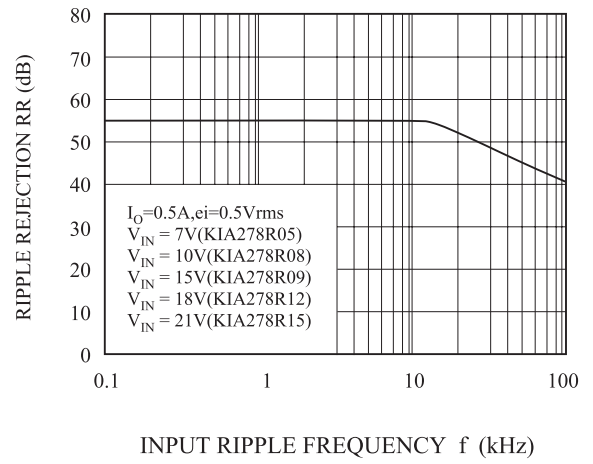

Fig.10-2  $I_O$  - RR

