

PRODUCT NO.	RoHS compliant
DSIC12LSGET	

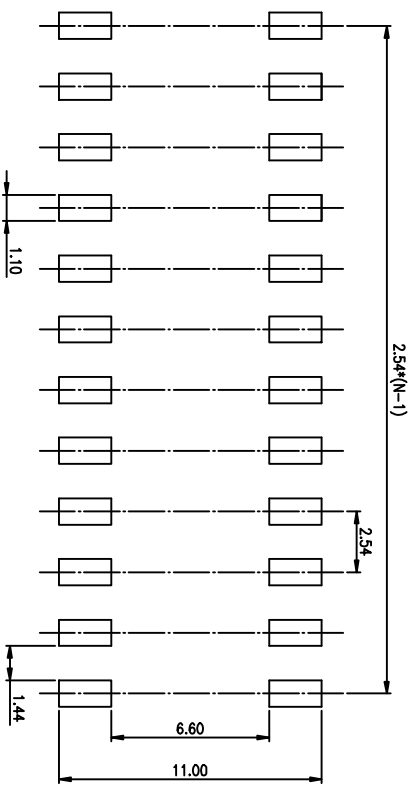
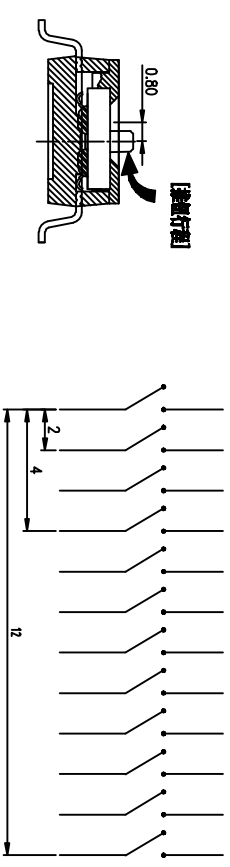
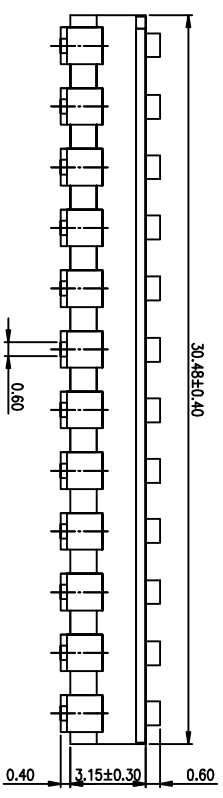
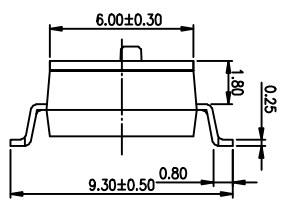
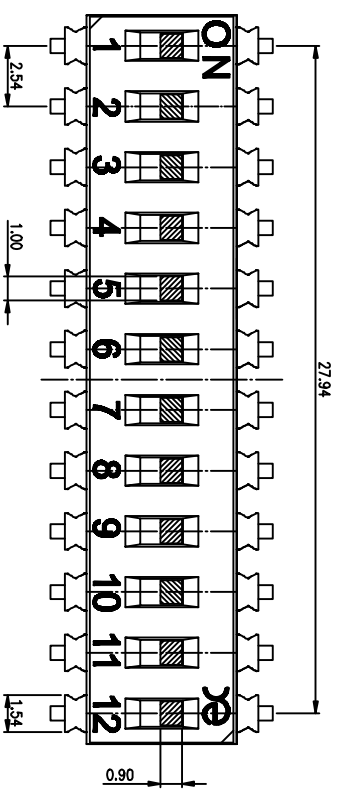

NOTES :

- 1> Specification:
  - 1> Operating force: 1000gf Max
  - 2> Operating Temperature: -40° to+85°
  - 3> Storage Temperature: -40° to+85°
  - 4> Mechanical Life: 3000cycles minimum
  - 5> Electrical Life: 2000cycles minimum
2. PLATING:
  - GOLD FLASH 1u"(min.) SOLDER TAIL,
  - 3u" GOLD PLATING ON THE CONTACT AREA,
  - WITH 50u" NICKEL UNDERPLATINGOVERALL.

3. PART NUMBER DESCRIPTION

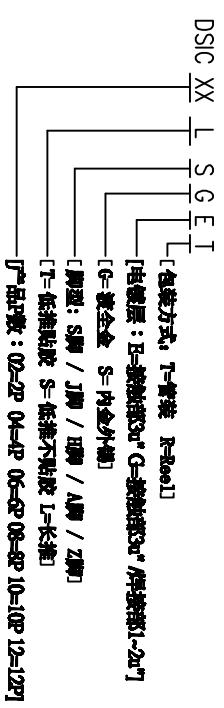

RECOMMENDED P.C.B. LAYOUT (TOP VIEW)

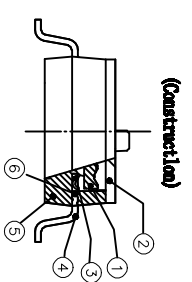

Number	Part Name	Material	Finished
①	Actuator	UL94 V0	White
②	Cover	UL94 V0	Black
③	Movable	Copper Alloy	3u"Gold
④	Terminal	Brass	1u"Gold
⑤	Base	UL94 V0	Black
⑥	Terminal Contact	Brass	3u"Gold

TOLERANCE UNLESS OTHERWISE SPECIFIED		INSPECTION	
LINER	ANGLES	COPY	PROJECTION
0 ± 0.25	0. ± 2'		
.00 ± 0.15	.0 ± 1'		
.000 ± 0.10	.00 ± 0.5'		
DESIGN	kathy	2012/04/12	
DRAWING			
CHECK			
APPRO.			

**东莞市广誉实业有限公司**  
Dongguan Kingtek Industrial Co., Ltd.

FILE NO.	DSIC12LSGET-A
SIZE	UNIT SCALE SHEET REV.
A4	mm 2 : 1 1 OF 1 A