

■ 塑胶薄膜电容器

Technical Terms & Calculation Formulae

术语说明及计算公式

介质材料

塑料薄膜电容器之电气特性主要取决于所使用之介质材料之性质。

聚乙烯酯 (PE) 膜

PE 膜具有较高之介质损耗，从而使其较适用于 10KH 以下之应用。

同时 PE 膜具有较高之介质常数，因此可以较小尺寸得到所需之容值。

而且 PE 膜之使用温度范围较其他常用之介质来得广阔。

PE 薄膜电容器公认属于一般用途之电容器，具有最佳之体积效率，而且价格较低，最适合使用于各种直流电路之应用，例如耦合，旁路，封锁及除噪等线路。

聚丙烯 (PP) 膜

PP 膜具有较低之损耗因素及介质损耗，从而使其适合高压高频及高脉冲电流之应用。

PP 薄膜电容器适用于高频之交流或脉冲电路之应用，例如驰返，调频及校正电路。

而且还广泛使用于开关式电源供应器，SNUBBER, 频率辨别及滤波电路，还适用于储能方面之应用。

薄膜电容器

塑料薄膜电容器可通分为膜箔式电容器与金属化膜电容器两大类。

膜箔式电容器

基本上膜箔式电容器由一双极版所构成，而极板间则由一绝缘塑料薄膜（亦称介质）分隔开。

而端子（或导线）则分别联接至一极板（一般为有感型），或者联接至电容素子之两端面（无感型）。膜箔式电容器具有高耐压强度，极佳之耐电流与耐脉冲能力，以及极佳之容值稳定性。

金属化膜电容器

金属化膜电容器之电极由一层极薄（厚仅 0.02um~0.1um 之铝质真空镀于介质薄膜或另外之载体薄膜之上所构成。而目前使用于薄膜电容器之介质材料之厚度则在 0.9um 与 20um 之间。

金属化膜电容器之素子端面需喷上焊接材料（俗称喷金层），而后再以焊接或熔接方式分别联接端子或导线，金属化膜电容器均具有高体积效率及具有自愈性之优点。

金属化膜电容器之自愈性质

所谓自愈是指可以自行排除由针孔，薄膜瑕疵或外部瞬间高压所导致之层间短路不良，而恢复正常。

在层间短路时电弧所产生之热能将失效点周围之极薄镀层蒸发，因此排除并隔离短路现象。自愈过程仅需数 U_w 之能量，而且通常在 10us 以内完成。较广泛而连续之自愈（例如误用）则会逐步降低容值。

■ 介质性质（典型参数）

参数	介质常数 25°C/50Hz	最小厚度 (micron)	最高工作温度 °C	损耗因数 at 1KHz(%)	绝缘电阻 (MΩ, μF)	吸湿度%重 量比	温度系数 (ppm/°C)
PE	3.2	1	125	0.5	25,000	0.4	+400 ± 200
PP	2.2	4	105	0.02	100,000	0.01	-200 ± 100

Technical Terms & Calculation Formulae

术语说明及计算公式

额定电压 (VR)

额定电压为电容器设计时予以设定之工作电压,指该电容器在操作温度+85℃以内,可以连续加于电容器端子间之最大直流电压(Vdc)或最大交流电压有效值(VRMS)或脉冲电压。

电容器之额定电压取决于介质材料特性,薄膜厚度及操作温度,如果操作温度高于+85℃但低于最高湿度,则额定电压应予以降低。

耐压强度或介质强度 (VT)

电容器之耐压强度高于其额定电压,但只能在有限时间内施加,一般耐压强度是在两电极间测试,典型的测试时间为2秒。

对金属化膜电容器而言,在耐压测试过程中出现自愈现象是可以容许的。

交流电压 (VAC)

本型录中所提及之交流电压额定电压均指无脉冲之弦波电压。因此除MPX型号以外,本型录之其他电容器均不应使用电力应用上(例如直接跨接交流电源)。

若使用于较高频率,则可使用之交流电压应予降低,降低比例请参见本型录中相关之,(容许交流电压 vs 频率曲线图)。

脉冲电压

脉冲电压之RMS有效值(VRMS)不可高于电容器之额定交流电压(VR(AC))。

$$VR(AC) \geq VRMS$$

脉冲电压之峰值(Vo-p)不可高于电容器之额定直流电压(VR(DC))。

$$VR(AC) \geq Vo-p$$

印加交流电压

当一交流电压印加于直流电压时,直流电压(VDC)与所印加交流电压峰值(Vo-p)之总和不可高于电容器之额定直流电压(VR(DC))。

$$VR(DC) \geq VDC + Vo-p$$

周温 (Tamb)

所谓周温是指电容器近周之温度,并不一定是室温。通常,周温与未加负载之电容器表面温度是一致的。

最高温度 (Tmax)

最高温度或称上限温度是指电容器仍可维持运作之最高温度。

在负载情形下,周温与因负载引致之温升总和不可超过电容之最高温度。

最低温度(Tmin)

最低温度或称下限温度是指电容器仍可维持运作之最低温度。

额定容值 (CR)

额定容值之定义为在电容器包括理想电容与等效串联电阻之等效串联电路中之电容那份。额定容值为电容器设计时设定之主要参数。

额定容值之测定应在测试电压1 VRMS max,测试频率在1KHz ±20%及周温+20℃条件下进行。容值容许差表示在+20℃条件下电容器之容值与额定容值间可接受之最大偏移范围。由于介质薄膜之介质常数与频率有关,容值会随着频率之上升而降低。高相对湿度则会使容值上升,而此项改变是可逆的。

容值漂移 (长期稳定性)

除了可逆性变化以外,电容器之容值也会有些不可逆之变化,亦称漂移。

漂移之方向与程度主要取决于介质材料,随着时间推移,漂移现象会逐频减小趋于稳定,经常或剧烈之温度变化可能增大漂移值。

温度系数 (TC)

温度系数是指在指定温度范围内,容值之平均变化率。

对电容器而言,一般在+20℃时之容值为基数计算,表示温度每变化1℃时容值之变化程度。温度系数为正为负依介质材料而定。

$$TC = \frac{(C2 - C1) \times 1,000,000}{C20 \times (T2 - T1)} \quad (\text{ppm}/^\circ\text{C})$$

C1=温度 T1 时之容值 (uF)

C2=温度 T2 时之容值 (uF)

C20=+20±2℃时之参考容值(uF)

Technical Terms & Calculation Formulae

术语说明及计算公式

损耗因素(DF) (tan δ)

损耗因素，亦“tan δ”，为电容器之等效串联电阻（ESR）与其容抗之比值，或为在特定频率之正弦波电压下，电容器之主动功率与感应功率之比值。

损耗因素一般反应介质薄膜之极化损耗及电容器导体接触电阻引起之损耗之大小，对薄膜电容器而言，由绝缘电阻产生之并联损耗是可以忽略的。

损耗因素随温度及频率而异，并非固定值。

$$DF = \frac{ESR}{X_c}$$

损耗因素之倒数亦称为 Q 因素。

$$Q = \frac{1}{\tan \delta}$$

等效串联电阻 (ESR)

等效串联电阻 (ESR) 系一等效串联电路之电阻部份，其值为假设电容器之所有损耗由与理想电容器串联之单一电阻来代表。下图右方为电容器之等效串联电路。



等效串联电阻 (ESR) 一般由介质材料之极化损耗 (RP)，绝缘电阻损耗 (RI)，及由导线导体之接触电阻所产生之损耗 (RS) 三部份构成。上图左为电容器代表性电路。

$$ESR = \frac{\tan \delta}{2 \pi f c} (\Omega)$$

绝缘电阻 (RI) 与时间常数 (t)

The insulation resistance is the ratio of an applied 绝缘电阻是电容器在充电停止后，该充电电压与流经介质及电容器外表面之漏电流之比值。

典型之绝缘电阻测试应在 +20°C 温度及相对湿度 50 ± 2% 环境下，于充电停止后 60 ± 5sec 进行。

$$RI = \frac{VDC}{IL} (\Omega)$$

绝缘电阻随介质材料之种类及品质与电容器之结构而异，绝缘电阻亦随着环境温度及/或湿度之上升而下降而回升。

对较大容值之电容器而言，其绝缘电阻系以时间常数 (t) 来表示，其为绝缘电阻与容值之乘积，单位为秒或 MΩ · uF。

$$t = RI \times C (M\Omega \cdot uF)$$

电感量(L)

电容器之电感量取决于电容素子之结构设计及导电端子之长度与厚度幅向导线型电容器之典型电感值为 1.0nH/1mm 导线长。

阻抗 (Z)

电容器之阻抗为其等效串联电阻 (ESR) 与容抗之向量和之大小。在此等效串联电路中一串联电感也列入考虑。

$$Z = \sqrt{ESR^2 + (\omega L - 1/\omega C)^2}$$

损耗功率

$$PD = V_{RMS}^2 \times 2 \pi f c \times \tan \delta \times 1000 (mW)$$

PD=损耗功率 (mW)

VRMS=电压 RMS 有效值 (V)

F=频率 (Hz)

C=容值 (F)

Tan=在频率 F 下之损耗因素 (DF)

共振频率 (f R)

共振频率 (f R) 是电容器之容值 C 与电感量 L 之函数。在共振频率下，电容器之容抗与感抗相等 ($1/\omega C = \omega L$)

在此共振曲线之底部，只有电阻部份是有效的，其阻抗 Z 等于其等效串联电阻 (ESR)。高于共振频率后，感抗将大于容抗。

脉冲上升梯度 (dv/dt)

电容器之脉冲上升梯度表示其耐受快速之电压变化及相应之高电流峰值之能力。

脉冲上升梯度以 V/us 为单位，代表一脉冲电压 (上升或下降) 曲线中最陡峭的坡度。

电容器之脉冲上升梯度取决于介质材料之特性，厚度及电容结构。

对膜箔式电容器而言，dv/dt 几乎不受限，只要该脉冲负载所引致之温升仍不超限即可。

脉冲负载与电流处理能力

为避免电容器过热，下列因素应详加考虑：

最大电压峰值 (Vp-p) . 脉冲形状，dv/dt，频率，脉冲电流，环境温度 (Tamb) 及冷却条件。

■ 塑胶薄膜电容器使用说明及注意事项

电容器工作电压

薄膜电容器的选用取决于施加的最高电压，并受施加的电压及电压波形，频率，环境，温度等因素的影响。使用前请确认施加到电容器两端的电压是否在额定电压值内，在任何时候都不要超过电容器的额定上限电压，即 $1.1U_r$ 。

电容器工作电流

通过电容器的脉冲电流等于电容量 C 与电压上升速率的乘积即 $I=C \times dv/dt$ 。通过电容的交流电流 $I=2\pi fcv$ 。（ f -电容器的最高频率； C -电容器的最高容量； v -电容器的最高电压）在任何时候都不要超过电容器的额定上限电流，即 $1.3I_r$ 。

对于使用在频率较高或高脉冲及交流条件下，SINCERITY 推荐客户使用聚丙烯膜电容器。不允许直流电容器使用在交流场合。

为了承受较大电流，从设计来讲，可以增加电容器的 dv/dt 值，可以增加电容器的端面面积 S ；也可以减小电容器的本体长度 L 或者增加电容器的电极的厚度，这需要确认电容器的使用场合和安装尺寸而不同。

电容器使用温度范围

电容器的使用温度定义为环境温度+电容器自身温度+环境辐射温度引起的温升，在交流或高频线路中电容器由于电流通过而发热，如温升过高将会烧毁电容器。

聚酯膜电容器温升在 10°C 以下，聚丙烯膜温升在 5°C 以下，可以正常使用。SINCERITY 建议电容器使用的温度不要超过其额定温度和自身温升范围内。

电容器机械谐振(噪音)

在交流及离散频率情形下，电容器的介质层可能产生机械振动而发出交流哼声(俗称噪音)，就目前的技术资料和 SINCERITY 试验判定对电容器的电性能使用没有任何影响，SINCERITY 还是建议使用前确认一下，目前只能尽量降低其交流哼声，完全杜绝是比较困难的。

电容器的电容量稳定性

尽管薄膜电容器以电容量稳定著称，如使用在 RC 定时电路中电容量稳定很高的场合，SINCERITY 推荐使用聚丙烯电容器或都由聚丙烯与聚脂混合介质薄膜而成的电容器。

抑制电源电磁干扰用电容器

一般分为两类“跨接电源线之间的 X 类抑制电源电磁干扰用电容器和跨接电线与地之间的 Y 类抑制电源电磁干扰用电容器”。

X 类与 Y 类电容器的峰值耐电压如下表：

类别	跨接绝缘类型 IEC664	使用时的脉冲峰值电压	电路应用	耐久性试验前施加的脉冲峰值电压
X1	III	$>2.5\text{KV}$ $<4.0\text{KV}$	高脉冲应用	$CR \leq 1.0 \mu\text{F}, 4\text{KV}$ $CR > 1.0 \mu\text{F}, 4 \sqrt{CR}$
X2	II	$\leq 2.5\text{KV}$	一般应用	$CR \leq 1.0 \mu\text{F}, 2.5\text{KV}$ $CR > 1.0 \mu\text{F}, 2.5 \sqrt{CR}$
X3	-----	$\leq 1.5\text{KV}$	一般应用	-----
Y1	双重绝缘或增强绝缘	4250VDC		8KV
Y2	基本绝缘或辅助绝缘	$>150\text{VAC}$ $<250\text{VAC}$		5KV
Y3	基本绝缘或辅助绝缘	$>150\text{VAC}$ $<250\text{VAC}$		
Y4	基本绝缘或辅助绝缘	$<150\text{VAC}$		2.5KV

电容器取用及存储

应避免带有锋利尖锐器件用力接触或碰撞电容器，会导致电容器的绝缘层的损坏引起电路板的短路，固定电容器时请使用阻燃材料，电容器的储存温度 $-10/+40^\circ\text{C}$ ，相对湿度不大于 75%。

■ 电容器的测试注意事项

电容量, 损耗角正切测试及环境

一般采用测试频率为 1KHz 均应在介质温度 20~25℃ 的范围进行。相对温度不大于 75%。气压为大气压。除另有约定外。

测试方法

端子间的电压:

测试漏电流一般设定在 10mA 但要根据电容器的电容量的大小适当增加或减小。电压施加的速度一般为 50V/S。若电压施加过快, 将使充电电流过大, 导致无法施加电压, 若采用交流测试, 其漏电流设定为 $I=2\pi fcv/1000(mA)$, 测试时间为 5S。

端子与外壳之间:

测试电压为 2UR+1000VAC, 但不低于 2000VAC。漏电流设定为 0.5mA, 测试时间为 60S。

电容器充电后请不要短路放电, 否则将损坏电容器, 最好采用电阻放电。

绝缘电阻的测试:

额定电压小于 10V, 测试电压为额定电压。 额定电压 10~100V (不含 100V) 测试电压为 10V。

额定电压 100~500V (不含 500V) 测试电压为 100V。 额定电压 500V (含 500V) 测试电压为 500V。

对于抑制电源磁干扰用 X 类与 Y 类等电容器测试电压为 100V。

■ 电容器的试验条件

项目	施加条件	性能要求
稳态湿热	温度: $40\pm 2^\circ\text{C}$ 湿度: 93%RH 持续时间: 21 天或 56 天	电容量: $\Delta C/C \leq 5\%$ 损耗角正切 (1KHz): 增加 ≤ 0.002 无可见损伤, 标志清晰
	绝缘电阻 IR;	\geq 额定值的 50%
而久性	额定温度 T_0 , 1000h 施加电压: 1.25 X 额定电压	电容量: $\Delta C/C \leq 10\%$ 绝缘电阻 IR: \geq 额定值的 50%
充电和放电	电容量: $\Delta C/C \leq$ 初始测量值的 $\pm 10\%$ 损耗角正切 (1KHz): tg 的增加 ≤ 0.001 绝缘电阻 IR: \geq 额定值的 50%	Refitemm4.13 次数: 10000 次 充电持续时间: 0.5S 放电持续时间: 0.5S 充电电压为额定电压 充电电阻: $220/C_r$ () 或 20 (取较大者) C_r 为标称电容量 (uF)
阻燃性试验	离开火焰后, 任一电容器继续燃烧的时间不超过 30S, 且电容器燃烧的滴落物不应引燃在其下铺设的棉纸。	IEC695-2-2 针焰法 耐燃性类别 C, 在火焰上暴露一次电容器体积: $V(\text{mm}^3) \leq 250$, 在火焰上暴露时间为 5S 电容体积: $250 < V(\text{mm}^3) \leq 500$, 在火焰上暴露时间为 10S 电容体积: $500 < V(\text{mm}^3) \leq 1750$, 在火焰上暴露时间为 20S 电容体积: $V(\text{mm}^3) > 1750$, 在火焰上暴露时间为 30S

■ 在订购或索要样品之前, 请尽可能多的提供以下信息

1. 额定工作电压: DC, AC 或其他。
2. 电容量及允许误差。
3. 最终产品种类: 电视机, 显示器, 开关电源, 电子节能灯, 小家电等。
用途或电路图: 直流回路, 交流脉冲回路 (S 校正电路, 行逆程电路, 尖峰吸收回路,) 跨线, 降压, 谐振, 滤波, 点火电路等。
5. 使用条件: 脉冲峰值, 频率, 波形, 电流等。电容器的使用环境温度。
6. 外形尺寸及形状: 电容器本体尺寸, 引线长度; 环氧包封或盒装, 直角, 成型, 编带等。
7. 安全性, 当电容器短路或者开路时是否对其他元器件有影响, 其他元器件异常是否对电容器有影响等。

■特性曲线图

Soldering/Frequency/Temperature Curves

焊锡温度、频率、温度特性曲线图

焊锡温度 VS 时间



频率特性



温度特性



■ 薄膜电容器编码规定

电容器料号编制方法

一. 封装型和轴向型电容器料号 18 位数产品代码如下：例如：MPP105K6231017###**



二. 盒装型电容器料号 15 位数产品代码如下：例如：MP2104KD2-###**



三. 各部分组成内容

①型号（第 1~3 位数）例如：MPP=CBB21 或 MPX-X2=MP2 产品系列型号代码见下表：

封装型号与轴向型号对应代码表						盒装型号对应代码表			
产品型号	代码	产品型号	代码	产品型号	代码	产品型号	代码	产品型号	代码
CBB21	MPP	CBB21A	MPS	CL11	PEI	CL233X	MEM	CBB21B	MPB
CL21X	MES	CBB13	PPN	CBB20T	MPT	MPX-X2	MP2	CBB81B	PPB
CBB81	PPS	CL20A	MEA	CL20T	MET	MKP-X1	MP1	CBB61	CB6
CBB90T	PPT	CBB90A	PPA	CBB20A	MPA	CL21B	MEB	R. C 组件	MRC
CL21	MEF								

②标称容量（第 4~6 位数） 例如：104=10×10 PF=0.1μF

③标容量误差代码（第 7 位数） 例如：J=±5% K=±10% M=±20%

④额定电压（第 8 位数）额定电压代码对应表

代码	电压	代码	电压	代码	电压	代码	电压	代码	电压
0	63 Vdc	6	630 Vdc	D	2000 Vdc	3	280 Vac	J	450 Vac
1	100 Vdc	8	800 Vdc	E	3000 Vdc	R	300 Vac	K	500 Vac
2	250 Vdc	A	1000 Vdc	F	125 Vac	H	350 Vac	L	600 Vac
4	400 Vdc	B	1250 Vdc	G	250 Vac	W	400 Vac	M	700 Vac
5	450 Vdc	C	1600 Vdc		275 Vac	T	440 Vac	S	2500Vdc
Q	520 Vdc								

注：当“G”用于 MP2 型号时代表 275 Vac，用于其它型号时代表 250 Vac

⑤外形编码（产品属于封装型和轴向型第 9~14 位数；产品属于盒装型第 9~10 位数）

⑥引线加工图形及切引线长度代码##（封装型和轴向型第 15、16 位数；盒装型第 12、13 位数）见附表 1

⑦塑壳颜色代码-（此码只适于盒装产品第 11 位数）

⑧内部识别码“**”（封装型和轴向型第 17、18 位数；盒装型第 14、15 位数）

引脚加工图形及切引线长度附表 1

说明：盒装型号标准引线长度为 13MM，封装型号标准引线长度为 26MM；轴向型号标准引线长度为 35MM。

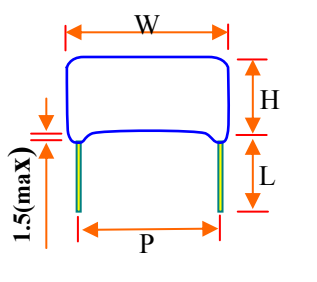
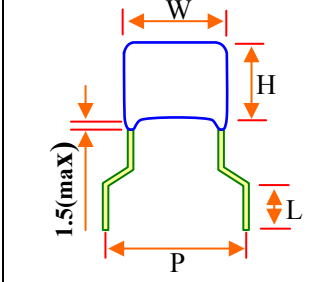
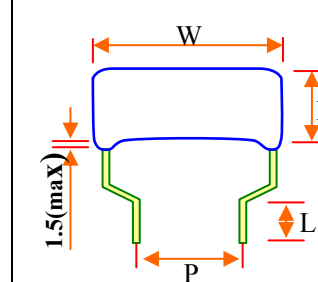
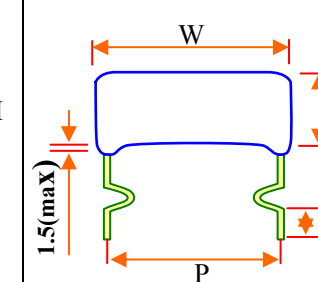
切引线标准长度	3.0±0.5 mm	3.5±0.5 mm	4.0±0.5 mm	4.5±0.5 mm	5.0±0.5 mm	5.5±0.5 mm
直切脚加工图形	外弯脚加工图形		内弯脚加工图形		K 弯脚加工图形	
						

■采用标准

GB10188(IEC384-13)

■结构

介质：聚丙烯膜

电极：金属真空蒸发层和铝箔

封装：阻燃粉末环氧树脂，符合 UL94 V-0

引脚：铜包钢镀锡（CP 线）或铜线

■典型应用

高频、直流、交流及脉冲大电流场合

如：灯具、电源，显示器及彩电行逆程线路等

电子整流器，节能灯等

■特点

有良好自愈性能。高频损耗小，温升低

高冲击强度。内部串联结构，电压高，过电流大等

■符合 ROHS 标准

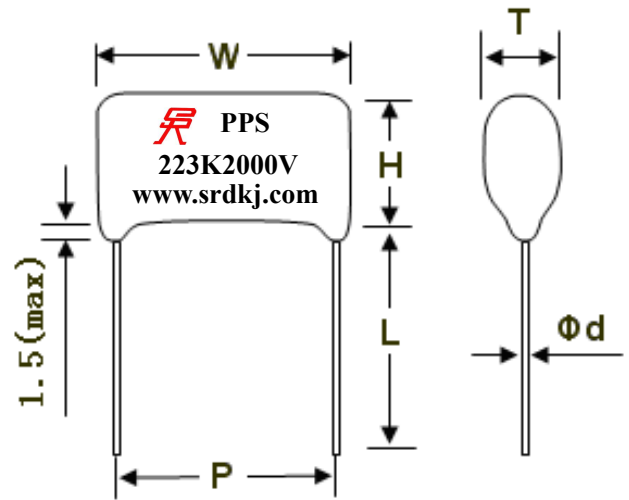

■技术参数

脚距 mm	10	15	20	22.5	27.5	31.5
引线直径 mm	0.6	0.6/0.8	0.8			
dv/dt(V/μs)	1000	1500	1000	500		

气候条件	-40—+85 (105) °C/56d	
额定电压	630VDC、1000VDC、1250VDC、1600VDC、2000VDC、3000VDC	
容量误差	J—±5% K—±10% M—±20%	
容量范围	0.0010 μF—0.47 μF	
耐电压	端子与端子：2.0UR 5S 端子与外壳：2000VAC 5S	无击穿或飞狐
损耗角	≤0.0010 10KHZ	20°C；1V 测试电压
绝缘电阻 或时间常数	CR≤0.33 μF IR≥30000MΩ CR>0.33 μF IR≥10000S(MΩ. μF)	UR≤500V, 充电电压 100V UR>500V, 充电电压 500V 20°C；充电 1min 测试后测得
稳态湿热	温度：40±2°C 湿度：93%RH 持续时间：56 天	无可见损伤，标志清晰 IR: ≥额定值的 50% 电容量：ΔC/C≤5% 损耗角（1KHZ）：增加≤0.0020
耐久性试验	+85 (105) °C，连续 10000 小时 施加电压：1.25×额定电压	绝缘电阻 IR: ≥额定值的 50% 电容量：ΔC/C≤10%

■结构图



- ① 金属化聚丙烯薄膜
- ② 喷金层
- ③ 引脚
- ④ 阻燃粉末环氧树脂
- ⑤ 铝箔
- ⑥ 聚丙烯薄膜

Permissible AC Voltage VS Frequency Curves

CBB81(PPS)

容许交流电压 VS 频率曲线图

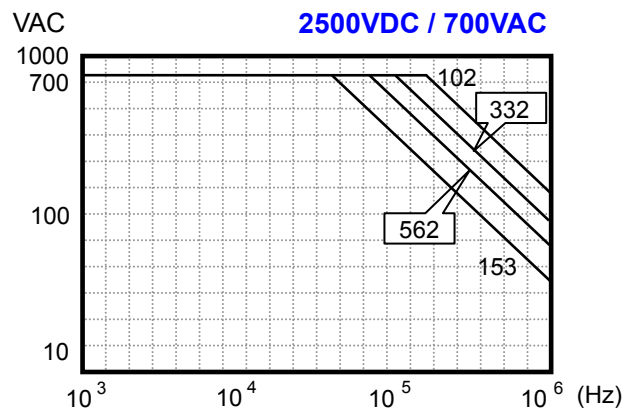
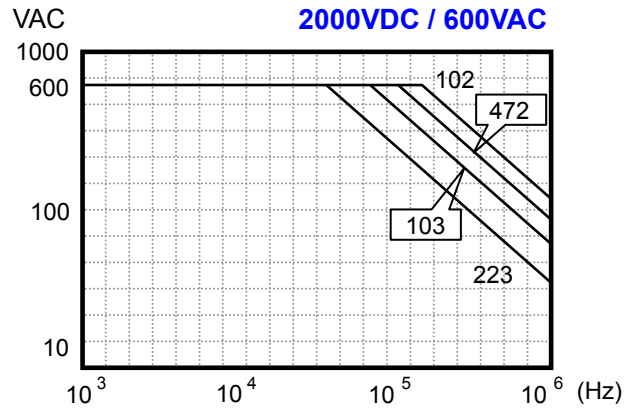
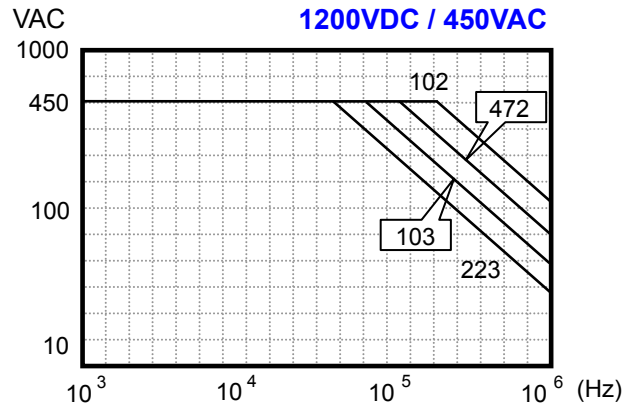



Permissible Pulse Current VS Frequency & Duty Tables

CBB81(PPS)

容许脉冲电流值 VS 频率与负载对照表

1000VDC

CAP (uF)	31.00KHz					37.00KHz					48.00KHz					56.00KHz								
	Vo-p (Volt)	Duty Time(uS)				Vo-p (Volt)	Duty Time(uS)				Vo-p (Volt)	Duty Time(uS)				Vo-p (Volt)	Duty Time(uS)							
		Duty (%)					Duty (%)					Duty (%)					Duty (%)							
	max.	30	25	20	15	10	max.	30	25	20	15	10	max.	30	25	20	15	10	max.	30	25	20	15	10
I p-p(Amp)max.																								
0.0010	900	1.6	1.9	2.3	3.2	4.7	900	1.7	2.0	2.6	3.4	5.1	900	2.0	2.3	2.9	3.9	5.9	900	2.1	2.6	3.3	4.4	6.5
0.0012	900	1.8	2.1	2.6	3.5	5.2	900	2.0	2.3	2.9	3.9	5.8	900	2.2	2.7	3.4	4.6	6.8	900	2.4	2.9	3.6	4.8	7.3
0.0015	900	2.0	2.3	2.9	3.9	5.8	900	2.1	2.5	3.2	4.3	6.3	900	2.5	3.0	3.7	5.0	7.5	900	2.7	3.2	4.0	5.3	8.0
0.0018	900	2.1	2.5	3.1	4.2	6.3	900	2.3	2.8	3.3	4.7	7.0	900	2.8	3.2	4.1	5.4	8.3	900	3.0	3.4	4.4	5.9	8.8
0.0022	900	2.3	2.8	3.4	4.6	6.9	900	2.5	3.0	3.7	5.0	7.6	900	3.0	3.5	4.5	6.0	8.9	900	3.2	3.8	4.7	6.3	9.6
0.0027	900	2.6	3.1	3.8	5.1	7.7	900	2.8	3.3	4.2	5.6	8.4	900	3.3	3.9	4.8	6.4	9.7	900	3.4	4.1	5.2	6.9	10.3
0.0033	900	2.9	3.4	4.3	5.7	8.5	900	2.1	3.7	4.7	6.1	9.3	900	3.5	4.3	5.3	7.2	10.7	900	3.8	4.6	5.7	7.6	11.4
0.0036	900	3.0	3.5	4.4	5.9	8.8	900	3.3	3.8	4.8	6.4	9.7	900	3.7	4.5	5.6	7.4	11.2	900	4.0	4.7	6.0	7.9	11.9
0.0039	900	3.1	3.6	4.6	6.0	9.1	900	3.3	4.0	5.0	6.6	10.0	900	3.8	4.7	5.8	7.7	11.5	900	4.1	4.9	6.1	8.2	12.4
0.0043	900	3.2	3.7	4.7	6.2	9.3	900	3.4	4.1	5.1	6.8	10.2	900	3.9	4.7	6.0	7.9	11.8	900	4.2	5.1	6.3	8.5	12.6
0.0047	900	3.3	3.8	4.8	6.4	9.7	900	3.5	4.2	5.3	7.1	10.6	900	4.1	4.9	6.1	8.2	12.2	900	4.4	5.3	6.5	8.7	13.1
0.0051	900	3.3	4.0	5.0	6.7	10.0	900	3.7	4.4	5.5	7.3	11.1	900	4.3	5.1	6.4	8.6	12.7	900	4.6	5.5	6.8	9.1	13.7
0.0056	900	3.5	4.2	5.2	7.0	10.5	900	3.8	4.6	5.8	7.6	11.4	900	4.5	5.3	6.6	8.8	13.3	900	4.7	5.7	7.1	9.5	14.2
0.0062	900	3.6	4.4	5.5	7.3	11.0	900	4.0	4.7	6.0	8.0	11.9	900	4.7	5.5	6.9	9.2	13.9	900	4.9	6.0	7.4	9.9	14.8
0.0068	900	3.9	4.7	5.9	7.8	11.7	900	4.2	5.0	6.1	8.5	12.6	900	4.8	5.8	7.3	9.6	14.4	900	5.1	6.2	7.8	10.3	15.4
0.0075	900	4.0	4.8	6.0	8.1	12.1	900	4.3	5.2	6.4	8.7	12.9	900	5.0	6.0	7.4	10.0	15.0	900	5.3	6.4	8.1	10.7	16.0
0.0082	900	4.2	5.0	6.3	8.5	12.6	900	4.5	5.4	6.8	9.0	13.5	900	5.2	6.2	7.8	10.4	15.6	900	5.6	6.7	8.4	11.2	16.7
0.0091	900	4.4	5.2	6.5	8.7	13.1	900	4.7	5.7	7.1	9.4	14.0	900	5.4	6.5	8.2	10.9	16.3	800	5.9	7.0	8.7	11.6	17.5
0.010	900	4.6	5.5	6.9	9.1	13.7	900	4.9	6.0	7.4	10.0	14.9	800	5.8	6.9	8.6	11.5	17.3	800	6.1	7.3	9.2	12.3	18.5
0.012	900	5.1	6.2	7.7	10.3	15.4	900	5.5	6.6	8.3	11.1	16.6	800	6.3	7.5	9.4	12.6	18.9	800	6.7	8.1	10.0	13.5	20.2
0.015	900	5.7	6.9	8.6	11.4	17.1	800	6.1	7.3	9.2	12.3	18.4	800	7.1	8.5	10.6	14.0	21.1	800	7.5	9.0	11.3	15.1	22.6
0.018	900	6.4	7.6	9.6	12.7	19.2	800	6.9	8.3	10.3	13.8	20.6	800	7.9	9.5	11.8	15.8	23.6	800	8.5	10.1	12.6	16.9	25.3
0.022	800	7.1	8.6	10.6	14.2	21.3	800	7.6	9.1	11.4	15.3	22.9	800	8.7	10.5	13.1	17.5	26.2	700	9.4	11.3	14.0	18.8	28.1

■ 测试条件

环境温度: +85°C ±5°C
 相对湿度: 65% -- 95%
 上升温度 (ΔT): 8°C max.

■ 电压波形



■ 电流波形

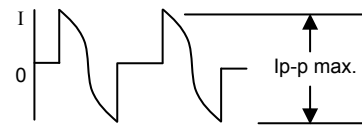

CAP (uF)	64.00KHz					78.00KHz					82.00KHz					96.00KHz								
	Vo-p (Volt)	Duty Time(uS)				Vo-p (Volt)	Duty Time(uS)				Vo-p (Volt)	Duty Time(uS)				Vo-p (Volt)	Duty Time(uS)							
		Duty (%)					Duty (%)					Duty (%)					Duty (%)							
	max.	30	25	20	15	10	max.	30	25	20	15	10	max.	30	25	20	15	10	max.	30	25	20	15	10
I p-p(Amp)max.																								
0.0010	900	2.3	2.8	3.5	4.7	7.1	900	2.6	3.2	4.0	5.3	7.9	900	2.7	3.3	4.1	5.4	8.2	900	3.0	3.6	4.5	6.0	9.0
0.0012	900	2.5	3.1	3.8	5.1	7.6	900	2.9	3.4	4.3	5.7	8.6	900	3.0	3.5	4.5	5.9	8.8	900	3.3	3.9	4.8	6.5	9.8
0.0015	900	2.8	3.3	4.2	5.6	8.4	900	3.2	3.7	4.7	6.2	9.4	900	3.3	3.9	4.8	6.4	9.7	900	3.5	4.3	5.4	7.2	10.7
0.0018	900	3.0	3.6	4.7	6.1	9.3	900	3.3	4.0	5.2	6.9	10.3	900	3.5	4.3	5.3	7.2	10.7	900	3.9	4.7	5.9	7.9	11.8
0.0022	900	3.3	4.0	5.0	6.7	10.0	900	3.7	4.5	5.6	7.4	11.2	900	3.8	4.7	5.8	7.7	11.5	900	4.3	5.1	6.4	8.5	12.7
0.0027	900	3.6	4.4	5.4	7.3	10.9	900	4.1	4.8	6.0	8.1	12.1	900	4.2	5.0	6.2	8.4	12.5	900	4.7	5.5	6.9	9.1	13.8
0.0033	900	4.0	4.7	6.0	7.9	11.9	900	4.5	5.3	6.6	8.8	13.3	900	4.6	5.4	6.8	9.0	13.6	900	5.0	6.0	7.5	10.0	15.0
0.0036	900	4.2	4.9	6.2	8.3	12.6	900	4.7	5.6	6.9	9.3	13.9	900	4.7	5.7	7.1	9.4	14.1	900	5.2	6.3	7.9	10.5	15.5
0.0039	900	4.3	5.1	6.4	8.6	12.9	900	4.8	5.8	7.2	9.6	14.3	900	4.9	6.0	7.3	9.8	14.7	900	5.4	6.6	8.2	11.0	16.2
0.0043	900	4.4	5.3	6.6	8.9	13.3	900	5.0	6.0	7.4	9.9	14.8	900	5.1	6.1	7.6	10.1	15.3	900	5.6	6.8	8.5	11.3	16.8
0.0047	900	4.6	5.5	6.9	9.2	13.7	900	5.2	6.1	7.7	10.2	15.3	900	5.3	6.3	7.9	10.5	15.8	900	5.9	7.0	8.7	11.7	17.5
0.0051	900	4.7	5.8	7.2	9.6	14.2	900	5.4	6.4	8.0	10.7	16.0	900	5.5	6.6	8.2	11.0	16.6	900	6.0	7.3	9.0	12.1	18.0
0.0056	900	4.9	6.0	7.4	10.0	14.9	900	5.6	6.7	8.4	11.1	16.6	900	5.7	6.9	8.5	11.4	17.1	800	6.2	7.5	9.4	12.6	18.7
0.0062	900	5.2	6.2	7.7	10.3	15.5	900	5.8	7.0	8.6	11.5	17.2	900	5.9	7.2	8.8	11.9	17.7	800	6.5	7.8	9.8	13.0	19.3
0.0068	900	5.4	6.5	8.1	10.8	16.3	900	6.0	7.3	9.0	12.1	18.0	800	6.1	7.4	9.2	12.4	18.9	800	6.8	8.2	10.2	13.6	20.3
0.0075	900	5.6	6.8	8.5	11.3	16.7	800	6.3	7.5	9.4	12.6	18.8	800	6.4	7.7	9.6	12.8	19.3	800	7.1	8.6	10.7	14.2	21.3
0.0082	800	5.9	7.1	8.8	11.7	17.6	800	6.6	7.9	9.9	13.1	19.6	800	6.8	8.1	10.0	13.4	20.3	800	7.4	8.9	11.2	14.9	22.3
0.0091	800	6.1	7.3	9.2	12.2	18.3	800	6.9	8.2	10.3	13.7	20.5	800	7.1	8.5	10.5	14.0	21.1	800	7.8	9.3	11.6	15.5	23.3
0.010	800	6.4	7.8	9.7	12.9	19.3	800	7.3	8.6	10.8	14.4	21.7	800	7.3	8.8	11.1	14.8	22.1	700	8.2	9.8	12.3	16.4	24.5
0.012	800	7.1	8.5	10.6	14.1	21.1	800	7.9	9.5	11.8	15.8	23.6	700	8.1	9.8	12.2	16.3	24.4	700	8.9	10.8	13.5	17.9	26.9
0.015	800	7.9	9.5	11.9	15.8	23.7	700	8.7	10.5	13.1	17.5	26.3	700	9.0	10.8	13.6	18.0	27.1	700	10.0	12.0	15.0	19.9	29.9
0.018	700	8.8	10.6	13.3	17.7	26.5	700	9.4	11.3	14.0	18.8	28.2	700	9.8	11.7	14.6	19.5	29.3	700	10.7	12.8	16.0	21.4	32.1
0.022	700	9.9	11.8	14.8	19.6	29.5	700	10.4	12.5	15.5	20.7	31.2	700	10.8	12.9	16.2	21.6	32.4	600	11.7	14.0	17.6	23.4	35.2

Permissible Pulse Current VS Frequency & Duty Tables

CBB81(PPS) 容许脉冲电流值 VS 频率与负载对照表

1200VDC

CAP (uF)	31.00 KHz					37.00 KHz					48.00 KHz					56.00 KHz								
	Vo-p (Volt) max.	Duty Time(uS)					Vo-p (Volt) max.	Duty Time(uS)					Vo-p (Volt) max.	Duty Time(uS)					Vo-p (Volt) max.	Duty Time(uS)				
		Duty (%)						Duty (%)						Duty (%)						Duty (%)				
		30	25	20	15	10		30	25	20	15	10		30	25	20	15	10		30	25	20	15	10
I p-p(Amp)max.					I p-p(Amp)max.					I p-p(Amp)max.					I p-p(Amp)max.									
0.0010	1000	1.7	2.0	2.5	3.3	5.0	1000	1.9	2.2	2.7	3.6	5.5	1000	2.0	2.5	3.1	4.2	6.2	1000	2.3	2.8	3.4	4.7	6.9
0.0012	1000	1.9	2.2	2.8	3.7	5.6	1000	2.0	2.5	3.1	4.1	6.1	1000	2.4	2.9	3.6	4.8	7.3	1000	2.6	3.1	3.9	5.2	7.8
0.0015	1000	2.0	2.5	3.1	4.1	6.1	1000	2.2	2.7	3.3	4.5	6.8	1000	2.7	3.2	4.0	5.3	8.0	1000	2.9	3.4	4.3	5.7	8.6
0.0018	1000	2.2	2.7	3.3	4.5	6.8	1000	2.4	3.0	3.7	4.9	7.3	1000	2.9	3.4	4.4	5.9	8.7	1000	3.2	3.7	4.7	6.2	9.4
0.0022	1000	2.4	2.9	3.7	4.9	7.4	1000	2.7	3.2	4.1	5.3	8.0	1000	3.2	3.8	4.7	6.3	9.5	1000	3.3	4.1	5.1	6.8	10.1
0.0027	1000	2.7	3.3	4.1	5.5	8.2	1000	3.0	3.5	4.5	5.9	8.8	1000	3.4	4.2	5.1	6.9	10.2	1000	3.6	4.5	5.5	7.3	11.1
0.0033	1000	3.0	3.6	4.6	6.0	9.0	1000	3.3	3.9	4.9	6.6	10.0	1000	3.8	4.6	5.7	7.6	11.4	1000	4.1	4.8	6.0	8.1	12.2
0.0036	1000	3.2	3.7	4.7	6.2	9.4	1000	3.4	4.1	5.1	6.8	10.2	1000	4.0	4.7	6.0	7.9	11.9	1000	4.3	5.1	6.3	8.5	12.7
0.0039	1000	3.3	4.0	4.9	6.6	9.9	1000	3.5	4.3	5.3	7.2	10.8	1000	4.2	5.0	6.2	8.4	12.6	1000	4.5	5.4	6.7	8.9	13.4
0.0043	1000	3.3	4.1	5.0	6.8	10.1	1000	3.6	4.4	5.5	7.3	11.1	1000	4.3	5.1	6.4	8.6	12.8	1000	4.6	5.5	6.9	9.1	13.8
0.0047	1000	3.4	4.2	5.1	6.8	10.2	1000	3.7	4.5	5.6	7.4	11.3	1000	4.4	5.2	6.5	8.6	13.0	1000	4.7	5.6	7.0	9.3	14.0
0.0051	1000	3.5	4.3	5.3	7.1	10.6	1000	3.9	4.7	5.8	7.7	11.6	1000	4.5	5.4	6.7	8.9	13.5	1000	4.8	5.8	7.2	9.6	14.4
0.0056	1000	3.7	4.4	5.5	7.3	11.1	1000	4.0	4.8	6.0	8.1	12.1	1000	4.7	5.6	7.0	9.3	14.0	1000	5.0	6.0	7.4	10.0	15.0
0.0062	1000	3.8	4.7	5.8	7.7	11.5	1000	4.2	5.0	6.3	8.4	12.6	1000	4.8	5.9	7.3	9.7	14.6	1000	5.2	6.2	7.8	10.4	15.6
0.0068	1000	4.0	4.8	6.0	8.0	12.1	1000	4.4	5.2	6.5	8.7	13.1	1000	5.0	6.0	7.5	10.0	15.2	1000	5.4	6.5	8.1	10.8	16.2
0.0075	1000	4.3	5.1	6.4	8.6	12.7	1000	4.6	5.5	6.8	9.1	13.6	1000	5.2	6.3	7.9	10.5	15.7	1000	5.6	6.7	8.5	11.3	16.8
0.0082	1000	4.5	5.4	6.8	9.0	13.5	1000	4.8	5.8	7.2	9.6	14.4	1000	5.6	6.7	8.4	11.1	16.6	1000	6.0	7.2	8.9	11.9	17.9
0.0091	1000	4.7	5.6	7.0	9.3	14.0	1000	5.0	6.0	7.5	10.0	15.0	1000	5.8	7.0	8.6	11.5	17.4	900	6.2	7.4	9.3	12.4	18.6
0.010	1000	4.8	5.9	7.3	9.7	14.5	1000	5.3	6.3	7.9	10.6	15.9	900	6.1	7.3	9.2	12.3	18.4	900	6.5	7.9	9.9	13.1	19.6
0.012	1000	5.6	6.7	8.3	11.1	16.6	1000	6.0	7.2	8.9	11.9	17.8	900	6.8	8.1	10.1	13.5	20.3	900	7.3	8.6	10.9	14.4	21.7
0.015	1000	6.0	7.3	9.1	12.2	18.2	900	6.5	7.8	9.8	13.0	19.6	900	7.5	9.0	11.3	15.0	22.5	900	8.0	9.6	12.0	16.0	24.1
0.018	1000	6.8	8.2	10.2	13.6	20.4	900	7.3	8.7	11.0	14.6	21.9	900	8.4	10.0	12.6	16.7	25.2	900	9.0	10.8	13.5	17.9	27.0
0.022	900	7.5	9.0	11.3	15.1	22.6	900	8.1	9.8	12.2	16.3	24.4	900	9.3	11.2	14.0	18.6	28.0	800	10.0	12.0	15.0	19.9	29.9

■ 测试条件

环境温度: +85°C ±5°C
 相对湿度: 65% -- 95%
 上升温度 (ΔT): 8°C max.

■ 电压波形



■ 电流波形

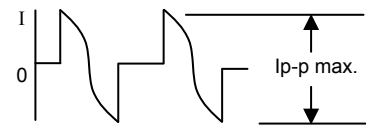

CAP (uF)	64.00 KHz					78.00KHz					82.00KHz					96.00KHz								
	Vo-p (Volt) max.	Duty Time(uS)					Vo-p (Volt) max.	Duty Time(uS)					Vo-p (Volt) max.	Duty Time(uS)					Vo-p (Volt) max.	Duty Time(uS)				
		Duty (%)						Duty (%)						Duty (%)						Duty (%)				
		30	25	20	15	10		30	25	20	15	10		30	25	20	15	10		30	25	20	15	10
I p-p(Amp)max.					I p-p(Amp)max.					I p-p(Amp)max.					I p-p(Amp)max.									
0.0010	1000	2.5	3.0	3.7	5.0	7.5	1000	2.8	3.3	4.2	5.6	8.5	1000	2.9	3.4	4.4	5.8	8.6	1000	3.2	3.8	4.8	6.4	9.6
0.0012	1000	2.7	3.3	4.1	5.4	8.2	1000	3.1	3.6	4.6	6.0	9.1	1000	3.2	3.7	4.7	6.2	9.4	1000	3.4	4.2	5.2	6.9	10.4
0.0015	1000	3.0	3.5	4.5	6.0	8.9	1000	3.3	4.0	5.0	6.7	10.0	1000	3.4	4.1	5.1	6.9	10.3	1000	3.8	4.5	5.7	7.6	11.3
0.0018	1000	3.3	3.9	4.9	6.6	9.9	1000	3.7	4.4	5.5	7.3	11.1	1000	3.8	4.6	5.7	7.5	11.3	1000	4.2	5.0	6.2	8.4	12.6
0.0022	1000	3.5	4.3	5.3	7.1	10.6	1000	4.0	4.7	6.0	7.9	11.9	1000	4.1	4.9	6.1	8.2	12.3	1000	4.6	5.4	6.8	9.0	13.5
0.0027	1000	3.8	4.7	5.8	7.7	11.5	1000	4.3	5.1	6.4	8.6	12.9	1000	4.5	5.3	6.7	8.8	13.3	1000	4.9	5.9	7.3	9.8	14.7
0.0033	1000	4.2	5.1	6.3	8.5	12.6	1000	4.7	5.7	7.1	9.5	14.1	1000	4.8	5.8	7.3	9.8	14.5	1000	5.3	6.4	8.0	10.7	16.0
0.0036	1000	4.5	5.3	6.7	8.8	13.3	1000	4.9	6.0	7.4	10.0	14.9	1000	5.1	6.1	7.6	10.2	15.3	1000	5.7	6.8	8.5	11.3	16.9
0.0039	1000	4.7	5.7	7.1	9.4	14.0	1000	5.1	6.3	7.9	10.5	15.7	1000	5.4	6.5	8.1	10.8	16.2	1000	6.0	7.2	8.9	11.9	17.9
0.0043	1000	4.8	5.8	7.2	9.6	14.4	1000	5.3	6.4	8.1	10.7	16.1	1000	5.5	6.6	8.3	11.1	16.6	1000	6.1	7.3	9.2	12.2	18.3
0.0047	1000	4.9	5.9	7.3	9.8	14.6	1000	5.5	6.5	8.2	10.9	16.3	1000	5.6	6.7	8.4	11.2	16.8	1000	6.2	7.4	9.3	12.4	18.6
0.0051	1000	5.0	6.0	7.5	10.0	15.1	1000	5.7	6.8	8.5	11.3	16.9	1000	5.8	7.0	8.7	11.6	17.4	1000	6.3	7.7	9.6	12.8	19.3
0.0056	1000	5.2	6.3	7.8	10.5	15.7	1000	5.9	7.0	8.7	11.7	17.6	1000	6.0	7.3	9.0	12.1	18.1	900	6.7	8.0	10.0	13.3	20.0
0.0062	1000	5.5	6.5	8.2	10.9	16.4	1000	6.1	7.3	9.1	12.2	18.3	1000	6.2	7.4	9.3	12.5	18.7	900	6.9	8.3	10.3	13.8	20.6
0.0068	1000	5.7	6.8	8.5	11.3	17.0	1000	6.3	7.6	9.5	12.6	19.0	900	6.4	7.7	9.7	12.9	19.3	900	7.2	8.6	10.7	14.2	21.4
0.0075	1000	5.9	7.1	8.8	11.8	17.7	900	6.6	7.9	9.9	13.1	19.7	900	6.8	8.1	10.1	13.6	20.4	900	7.5	9.0	11.3	15.0	22.5
0.0082	900	6.2	7.4	9.4	12.5	18.7	900	7.0	8.4	10.4	14.0	20.9	900	7.2	8.6	10.8	14.4	21.6	900	7.9	9.5	11.9	15.9	23.8
0.0091	900	6.5	7.8	9.8	13.0	19.4	900	7.3	8.7	10.9	14.5	21.8	900	7.4	9.0	11.3	15.0	22.4	800	8.3	10.0	12.4	16.6	24.8
0.010	900	6.9	8.3	10.3	13.8	20.6	900	7.7	9.2	11.5	15.3	23.1	900	7.9	9.4	11.8	15.7	23.6	800	8.6	10.4	13.0	17.4	26.0
0.012	900	7.6	9.1	11.3	15.2	22.8	900	8.5	10.1	12.7	16.9	25.4	800	8.7	10.5	13.1	17.5	26.2	800	9.7	11.5	14.5	19.3	28.9
0.015	900	8.4	10.1	12.6	16.8	25.2	800	9.3	11.2	14.0	18.6	28.0	800	9.6	11.5	14.4	19.3	28.8	800	10.6	12.7	15.9	21.2	31.8
0.018	800	9.4	11.3	14.1	18.8	28.3	800	10.0	12.0	15.0	20.0	29.9	800	10.4	12.5	15.6	20.7	31.2	800	11.3	13.7	17.0	22.7	34.1
0.022	800	10.4	12.6	15.7	20.9	31.3	800	11.1	13.2	16.6	22.0	33.1	800	11.5	13.8	17.2	23.0	34.5	700	12.5	15.0	18.7	24.9	37.4



Permissible Pulse Current VS Frequency & Duty Tables

CBB81(PPS)

容许脉冲电流值 VS 频率与负载对照表

1600VDC

CAP (uF)	31.00 KHz						37.00 KHz						48.00 KHz						56.00 KHz					
	Vo-p (Volt) max.	Duty Time(uS)					Vo-p (Volt) max.	Duty Time(uS)					Vo-p (Volt) max.	Duty Time(uS)					Vo-p (Volt) max.	Duty Time(uS)				
		Duty (%)						Duty (%)						Duty (%)						Duty (%)				
		9.7	8.1	6.5	4.8	3.2		8.1	6.8	5.4	4.1	2.7		6.3	5.2	4.2	3.1	2.1		5.4	4.5	3.6	2.7	1.8
30	25	20	15	10	30	25	20	15	10	30	25	20	15	10	30	25	20	15	10					
		I p-p(Amp)max.							I p-p(Amp)max.							I p-p(Amp)max.								
0.0010	1500	1.8	2.1	2.7	3.6	5.4	1500	2.0	2.4	3.0	4.0	6.0	1500	2.2	2.7	3.3	4.6	6.8	1500	2.5	3.0	3.7	5.0	7.5
0.0012	1500	2.0	2.4	3.1	4.1	6.1	1500	2.2	2.7	3.3	4.5	6.7	1500	2.6	3.2	4.0	5.3	7.9	1500	2.8	3.4	4.3	5.7	8.5
0.0015	1500	2.2	2.7	3.3	4.5	6.8	1500	2.5	3.0	3.7	4.9	7.4	1500	2.9	3.5	4.4	5.9	8.7	1500	3.1	3.7	4.7	6.2	9.3
0.0018	1500	2.5	3.0	3.7	4.9	7.4	1500	2.7	3.3	4.1	5.4	8.1	1500	3.3	3.8	4.8	6.4	9.7	1500	3.4	4.1	5.1	6.9	10.3
0.0022	1500	2.7	3.3	4.1	5.5	8.2	1500	3.0	3.5	4.4	6.0	8.8	1500	3.4	4.2	5.2	7.0	10.4	1500	3.6	4.5	5.6	7.4	11.2
0.0027	1500	3.0	3.6	4.5	6.0	9.0	1500	3.3	3.9	4.9	6.5	9.8	1500	3.8	4.6	5.7	7.5	11.3	1500	4.0	4.8	6.0	8.1	12.1
0.0033	1500	3.3	4.0	5.0	6.7	10.0	1500	3.6	4.4	5.5	7.3	11.0	1500	4.2	5.0	6.3	8.4	12.6	1500	4.5	5.4	6.7	8.9	13.4
0.0036	1500	3.4	4.2	5.2	6.9	10.3	1500	3.8	4.6	5.7	7.5	11.3	1500	4.4	5.3	6.6	8.7	13.1	1500	4.7	5.7	7.1	9.4	14.0
0.0039	1500	3.6	4.4	5.5	7.3	11.0	1500	4.0	4.8	6.0	8.0	12.0	1500	4.7	5.6	7.0	9.3	14.0	1500	4.9	6.0	7.4	10.0	14.9
0.0043	1500	3.8	4.6	5.8	7.6	11.5	1500	4.2	5.0	6.3	8.4	12.6	1500	4.8	5.9	7.3	9.8	14.6	1500	5.2	6.2	7.8	10.4	15.6
0.0047	1500	4.0	4.7	6.0	7.9	11.9	1500	4.4	5.2	6.5	8.6	13.0	1500	5.0	6.0	7.5	10.0	15.1	1500	5.4	6.5	8.1	10.8	16.2
0.0051	1500	4.2	5.0	6.3	8.5	12.6	1500	4.7	5.5	6.9	9.2	13.9	1500	5.3	6.4	8.0	10.7	16.0	1400	5.7	6.9	8.6	11.4	17.1
0.0056	1500	4.5	5.4	6.7	8.9	13.5	1500	4.9	5.9	7.3	9.9	14.7	1500	5.7	6.8	8.6	11.3	17.0	1400	6.0	7.3	9.1	12.2	18.2
0.0062	1500	4.7	5.7	7.1	9.5	14.1	1500	5.1	6.1	7.7	10.3	15.4	1500	6.0	7.2	8.9	11.9	17.9	1400	6.4	7.6	9.6	12.7	19.2
0.0068	1500	4.9	6.0	7.4	10.0	14.9	1500	5.4	6.5	8.1	10.8	16.2	1400	6.2	7.4	9.3	12.5	18.7	1300	6.7	8.0	10.0	13.3	20.0
0.0075	1500	5.3	6.4	8.0	10.6	16.0	1500	5.7	6.8	8.6	11.3	17.0	1400	6.5	7.9	9.9	13.1	19.6	1300	7.0	8.5	10.5	14.0	21.0
0.0082	1500	5.6	6.8	8.5	11.3	16.8	1400	6.0	7.2	9.0	12.0	17.9	1400	7.0	8.4	10.4	13.9	20.8	1300	7.4	8.9	11.2	14.9	22.3
0.0091	1500	5.9	7.0	8.7	11.6	17.5	1400	6.2	7.5	9.4	12.6	18.8	1300	7.3	8.7	10.9	14.5	21.8	1200	7.7	9.3	11.6	15.5	23.3
0.010	1400	6.1	7.3	9.1	12.2	18.3	1400	6.6	8.0	10.0	13.3	19.9	1300	7.7	9.2	11.5	15.3	23.1	1200	8.3	9.9	12.4	16.5	24.7
0.012	1400	7.0	8.4	10.5	14.0	20.9	1300	7.4	8.9	11.3	15.0	22.4	1200	8.5	10.2	12.7	17.0	25.5	1100	9.1	10.9	13.7	18.2	27.3
0.015	1400	7.6	9.2	11.5	15.3	23.0	1300	8.3	9.9	12.4	16.5	24.7	1200	9.5	11.3	14.2	18.9	28.4	1100	10.1	12.2	15.2	20.3	30.4
0.018	1300	8.8	10.3	12.9	17.2	25.9	1200	9.2	11.1	13.9	18.5	27.7	1100	10.6	12.7	15.9	21.2	31.9	1000	11.3	13.7	17.0	22.7	34.1
0.022	1300	9.6	11.5	14.3	19.2	28.7	1200	10.3	12.4	15.4	20.5	30.9	1000	11.8	14.2	17.8	23.6	35.4	1000	12.6	15.2	19.0	25.3	37.9

■ 测试条件

环境温度: +85°C ±5°C
 相对湿度: 65% -- 95%
 上升温度 (ΔT): 8°C max.

■ 电压波形

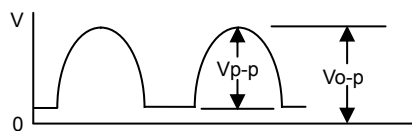

■ 电流波形

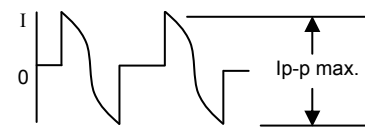

CAP (uF)	64.00 KHz						78.00 KHz						82.00 KHz						96.00 KHz					
	Vo-p (Volt) max.	Duty Time(uS)					Vo-p (Volt) max.	Duty Time(uS)					Vo-p (Volt) max.	Duty Time(uS)					Vo-p (Volt) max.	Duty Time(uS)				
		Duty (%)						Duty (%)						Duty (%)						Duty (%)				
		4.7	3.9	3.1	2.3	1.6		3.9	3.2	2.6	1.9	1.3		3.7	3.1	2.4	1.8	1.2		3.1	2.6	2.1	1.6	1.0
30	25	20	15	10	30	25	20	15	10	30	25	20	15	10	30	25	20	15	10					
		I p-p(Amp)max.							I p-p(Amp)max.							I p-p(Amp)max.								
0.0010	1500	2.7	3.3	4.1	5.5	8.2	1500	3.1	3.6	4.6	6.1	9.1	1500	3.2	3.8	4.7	6.3	9.4	1500	3.4	4.2	5.2	7.0	10.4
0.0012	1500	3.0	3.5	4.5	6.0	8.9	1500	3.3	4.0	5.0	6.6	10.0	1500	3.4	4.1	5.1	6.9	10.2	1500	3.8	4.6	5.7	7.5	11.3
0.0015	1500	3.3	3.9	4.9	6.5	9.8	1500	3.6	4.4	5.5	7.3	11.0	1500	3.7	4.6	5.7	7.5	11.3	1500	4.2	5.0	6.2	8.3	12.5
0.0018	1500	3.6	4.4	5.4	7.3	10.8	1500	4.0	4.8	6.0	8.1	12.1	1500	4.2	5.0	6.2	8.3	12.5	1500	4.6	5.5	6.9	9.2	13.8
0.0022	1500	3.9	4.7	5.9	7.8	11.7	1500	4.4	5.2	6.5	8.7	13.1	1500	4.5	5.4	6.7	9.0	13.5	1500	4.9	6.0	7.4	10.0	14.9
0.0027	1500	4.3	5.1	6.3	8.5	12.7	1500	4.7	5.7	7.1	9.5	14.2	1500	4.9	5.9	7.3	9.8	14.7	1500	5.4	6.5	8.1	10.8	16.2
0.0033	1500	4.7	5.6	7.0	9.2	14.0	1500	5.2	6.2	7.8	10.1	15.7	1500	5.3	6.4	8.0	10.7	16.0	1400	5.9	7.1	8.8	11.8	17.7
0.0036	1500	4.9	5.9	7.3	9.9	14.8	1500	5.5	6.6	8.3	11.0	16.5	1400	5.7	6.8	8.5	11.3	17.0	1400	6.2	7.5	9.4	12.6	18.8
0.0039	1500	5.2	6.2	7.8	10.4	15.6	1400	5.9	7.0	8.7	11.6	17.5	1400	6.0	7.3	9.0	12.0	18.0	1300	6.6	8.0	10.0	13.3	19.9
0.0043	1500	5.5	6.5	8.2	10.9	16.4	1400	6.1	7.3	9.1	12.2	18.3	1300	6.3	7.5	9.4	12.6	18.9	1300	7.0	8.4	10.4	13.9	20.8
0.0047	1400	5.7	6.8	8.5	11.3	16.9	1400	6.3	7.6	9.5	12.6	19.0	1300	6.5	7.8	9.8	13.0	19.5	1200	7.2	8.6	10.8	14.4	21.6
0.0051	1400	6.0	7.2	9.0	12.0	17.9	1300	6.7	8.0	10.0	13.4	20.1	1200	6.9	8.3	10.3	13.8	20.7	1200	7.6	9.1	11.4	15.3	22.9
0.0056	1300	6.4	7.6	9.6	12.7	19.2	1200	7.2	8.6	10.7	14.2	21.4	1200	7.3	8.8	11.1	14.7	22.0	1100	8.1	9.8	12.2	16.3	24.4
0.0062	1300	6.7	8.0	10.0	13.4	20.1	1200	7.4	9.0	11.3	15.0	22.4	1100	7.6	9.2	11.4	15.3	22.9	1100	8.5	10.1	12.6	16.8	25.3
0.0068	1200	7.0	8.4	10.5	14.0	20.9	1100	7.8	9.4	11.7	15.6	23.4	1100	8.0	9.6	12.0	15.9	23.9	1000	8.8	10.6	13.2	17.6	26.4
0.0075	1200	7.3	8.8	11.1	14.7	22.0	1100	7.8	9.9	12.4	16.5	24.6	1000	8.5	10.1	12.7	16.9	25.4	1000	9.4	11.3	14.0	18.7	28.1
0.0082	1100	7.8	9.4	11.7	15.6	23.3	1000	8.7	10.4	13.1	17.4	26.1	1000	9.0	10.8	13.5	17.9	27.0	1000	10.0	11.9	14.9	19.8	29.8
0.0091	1100	8.1	9.8	12.2	16.3	24.4	1000	9.1	10.9	13.7	18.2	27.2	900	9.4	11.3	14.0	18.8	28.1	900	10.3	12.5	15.5	20.7	31.1
0.010	1000	8.6	10.3	12.9	17.3	25.9	900	9.7	11.6	14.5	19.3	28.9	900	9.9	11.8	14.8	19.7	29.7	900	10.9	13.1	16.4	21.9	32.7
0.012	1000	9.6	11.4	14.3	19.1	28.6	900	10.7	12.8	16.3	21.4	32.0	800	11.0	13.2	16.5	22.0	33.0	800	12.2	14.6	18.2	24.3	36.5
0.015	900	10.6	12.7	15.9	21.2	31.9	900	11.8	14.1	17.7	23.5	35.3	800	12.1	14.5	18.2	24.3	36.4	800	13.4	16.1	20.1	26.8	40.2
0.018	900	11.9	14.3	17.9	23.8	35.7	800	12.5	15.2	19.0	25.3	37.9	800	13.1	15.8	19.7	26.3	39.4	800	14.4	17.3	21.6	29.4	43.2
0.022	900	13.3	15.9	19.9	26.5	39.8	800	14.0	16.8	21.0	28.0	42.0	800	14.6	17.5	21.9	29.2	43.7	700	15.8	19.0	23.7	31.6	47.4



Permissible Pulse Current VS Frequency & Duty Tables

CBB81(PPS)

容许脉冲电流值 VS 频率与负载对照表

2000VDC

CAP (uF)	31.00KHz					37.00KHz					48.00KHz					56.00KHz								
	Vo-p (Volt) max.	Duty Time(uS 10)					Duty Time(uS)					Duty Time(uS)					Duty Time(uS)							
		Duty (%)					Duty (%)					Duty (%)					Duty (%)							
		30	25	20	15	10	30	25	20	15	10	30	25	20	15	10	30	25	20	15	10			
I p-p(Amp)max.																								
0.0010	1800	2.6	3.1	3.9	5.2	7.7	1800	2.8	3.4	4.3	5.7	8.5	1800	3.3	3.9	4.9	6.5	9.9	1800	3.6	4.4	5.5	7.3	10.9
0.0012	1800	2.9	3.5	4.4	5.9	8.7	1800	3.3	3.9	4.8	6.4	9.7	1800	3.8	4.6	5.7	7.6	11.3	1800	4.1	4.8	6.1	8.1	12.2
0.0015	1800	3.2	3.7	4.7	6.2	9.4	1800	3.4	4.1	5.1	6.8	10.2	1800	4.0	4.8	6.0	8.1	12.1	1800	4.3	5.2	6.5	8.6	12.9
0.0018	1800	3.3	4.0	5.0	6.7	10.0	1800	3.6	4.4	5.5	7.3	11.0	1800	4.4	5.2	6.5	8.7	13.1	1800	4.7	5.6	7.0	9.3	14.0
0.0022	1800	3.7	4.4	5.5	7.3	10.9	1800	4.0	4.7	6.0	8.0	12.0	1800	4.7	5.7	7.1	9.5	14.1	1800	5.0	6.0	7.5	10.1	15.2
0.0027	1800	4.1	4.8	6.1	8.1	12.2	1800	4.4	5.3	6.6	8.8	13.2	1800	5.1	6.1	7.6	10.2	15.3	1800	5.5	6.6	8.2	11.0	16.5
0.0033	1800	4.5	5.3	6.7	8.9	13.4	1800	4.8	5.9	7.3	9.8	14.6	1800	5.6	6.7	8.4	11.2	16.7	1800	6.0	7.2	8.9	11.9	17.9
0.0036	1800	4.7	5.5	6.9	9.2	13.8	1800	5.0	6.0	7.5	10.0	15.2	1800	5.9	7.0	8.7	11.6	17.5	1800	6.2	7.5	9.4	12.5	18.7
0.0039	1800	4.8	5.8	7.3	9.7	14.5	1800	5.3	6.3	7.9	10.6	15.9	1800	6.1	7.3	9.2	12.3	18.4	1800	6.6	7.9	9.9	13.1	19.7
0.0043	1800	5.0	6.0	7.6	10.1	15.2	1800	5.6	6.6	8.3	11.1	16.6	1800	6.4	7.7	9.6	12.8	19.3	1800	6.9	8.3	10.3	13.8	20.6
0.0047	1800	5.3	6.3	7.9	10.6	15.8	1800	5.8	7.0	8.6	11.5	17.4	1800	6.7	8.0	10.0	13.4	20.1	1700	7.2	8.6	10.8	14.3	21.5
0.0051	1800	5.6	6.7	8.4	11.2	16.6	1800	6.0	7.3	9.1	12.2	18.2	1800	7.1	8.5	10.6	14.1	21.1	1700	7.5	9.0	11.3	15.1	22.6
0.0056	1800	5.9	7.1	8.8	11.8	17.7	1800	6.4	7.7	9.7	12.9	19.3	1800	7.4	8.9	11.3	15.0	22.4	1700	8.0	9.6	12.0	16.0	24.0
0.0062	1800	6.3	7.5	9.4	12.6	18.9	1800	6.9	8.2	10.2	13.7	20.6	1800	7.9	9.5	11.9	15.9	23.8	1600	8.5	10.2	12.7	17.0	25.5
0.0068	1800	6.7	8.0	10.0	13.3	20.0	1800	7.3	8.6	10.9	14.4	21.7	1800	8.4	10.0	12.6	16.7	25.0	1600	8.9	10.7	13.4	17.9	26.8
0.0075	1800	7.1	8.5	10.5	14.1	21.3	1800	7.5	9.1	11.3	15.2	22.7	1700	8.7	10.5	13.1	17.5	26.2	1600	9.3	11.3	14.0	18.7	28.0
0.0082	1800	7.4	8.9	11.2	14.9	22.3	1800	7.9	9.5	11.9	15.9	23.8	1700	9.2	11.1	13.8	18.4	27.5	1500	9.9	11.8	14.8	19.7	29.5
0.0091	1800	7.7	9.3	11.6	15.5	23.3	1800	8.4	10.0	12.5	16.6	25.0	1600	9.7	11.5	14.5	19.3	28.9	1500	10.3	12.4	15.5	20.6	31.0
0.010	1800	8.1	9.7	12.1	16.1	24.2	1800	8.7	10.5	13.1	17.6	26.3	1600	10.1	12.2	15.3	20.4	30.5	1400	10.9	13.0	16.3	21.8	32.6
0.012	1800	8.8	10.8	13.5	17.9	27.0	1700	9.7	11.5	14.4	19.3	28.9	1500	11.0	13.1	16.5	21.9	32.9	1400	11.7	14.0	17.6	23.4	35.2
0.015	1800	9.3	11.2	14.0	18.6	27.8	1700	10.1	12.2	15.3	20.3	30.5	1500	11.6	14.0	17.5	23.3	35.0	1400	12.5	15.0	18.7	24.9	37.5
0.018	1700	10.3	12.4	15.4	20.6	30.9	1700	11.2	13.4	16.7	22.3	33.5	1500	12.8	15.3	19.3	25.7	38.5	1300	13.8	16.5	20.6	27.4	41.2
0.022	1700	11.2	13.4	16.7	22.3	33.5	1600	12.0	14.4	18.0	24.0	36.0	1400	13.8	16.6	20.6	27.5	41.4	1300	14.8	17.7	22.1	29.5	44.3

■ 测试条件

环境温度: +85°C ±5°C
 相对湿度: 65% -- 95%
 上升温度 (ΔT): 8°C max.

■ 电压波形

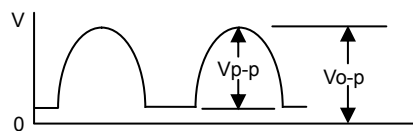

■ 电流波形

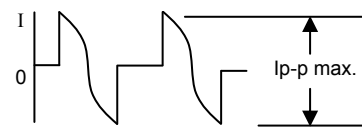

CAP (uF)	64.00KH6					78.00KHz					82.00KHz					96.00KHz								
	Vo-p (Volt) max.	Duty Time(uS)					Duty Time(uS)					Duty Time(uS)					Duty Time(uS)							
		Duty (%)					Duty (%)					Duty (%)					Duty (%)							
		30	25	20	15	10	30	25	20	15	10	30	25	20	15	10	30	25	20	15	10			
I p-p(Amp)max.																								
0.0010	1800	4.0	4.7	6.0	7.9	11.9	1800	4.5	5.3	6.6	8.8	13.3	1800	4.6	5.5	6.9	9.1	13.7	1800	5.1	6.1	7.6	10.2	15.3
0.0012	1800	4.3	5.1	6.4	8.6	12.7	1800	4.7	5.7	7.2	9.5	14.3	1800	4.9	5.9	7.3	9.9	14.7	1800	5.5	6.5	8.3	11.1	16.6
0.0015	1800	4.6	5.4	6.8	9.0	13.6	1800	5.0	6.0	7.6	10.1	15.2	1800	5.2	6.2	7.8	10.4	15.6	1800	6.0	7.1	8.9	11.8	17.8
0.0018	1800	4.9	5.9	7.3	9.8	14.7	1800	5.5	6.6	8.2	11.0	16.4	1800	5.7	6.8	8.5	11.3	16.9	1800	6.4	7.7	9.7	12.8	19.3
0.0022	1800	5.3	6.3	7.9	10.6	15.9	1800	6.0	7.1	8.9	11.8	17.8	1800	6.1	7.3	9.1	12.2	18.3	1700	7.0	8.4	10.5	14.0	21.0
0.0027	1800	5.8	6.9	8.6	11.4	17.2	1800	6.4	7.7	9.6	12.8	19.3	1700	6.6	7.9	10.0	13.2	19.8	1700	7.6	9.1	11.4	15.3	22.9
0.0033	1800	6.2	7.4	9.3	12.5	18.7	1700	7.0	8.4	10.4	14.0	20.8	1600	7.2	8.6	10.8	14.3	21.5	1600	8.3	9.9	12.4	16.5	24.7
0.0036	1700	6.5	7.9	9.9	13.1	19.6	1700	7.3	8.7	11.0	14.6	21.9	1600	7.5	9.0	11.3	15.1	22.6	1500	8.6	10.4	13.0	17.4	26.1
0.0039	1700	6.9	8.3	10.3	13.8	20.6	1600	7.7	9.2	11.5	15.4	23.2	1600	7.9	9.5	11.9	15.9	23.8	1500	9.1	11.0	13.7	18.2	27.3
0.0043	1700	7.2	8.6	10.8	14.4	21.6	1600	8.0	9.7	12.1	16.1	24.1	1500	8.3	10.0	12.5	16.6	24.8	1500	9.6	11.5	14.4	19.3	28.8
0.0047	1600	7.5	9.0	11.3	15.1	22.6	1600	8.4	10.0	12.6	16.8	25.2	1500	8.6	10.4	13.0	17.3	26.0	1400	10.0	12.1	15.1	20.1	30.1
0.0051	1600	7.9	9.5	11.9	15.8	23.7	1500	8.8	10.6	13.3	17.7	26.5	1500	9.1	11.0	13.7	18.2	27.3	1400	10.5	12.7	15.9	21.2	31.8
0.0056	1600	8.4	10.0	12.6	16.7	25.2	1500	9.4	11.3	14.0	18.8	28.2	1400	9.7	11.6	14.5	19.3	29.0	1400	11.1	13.3	16.6	22.2	33.3
0.0062	1500	8.9	10.7	13.4	17.8	26.7	1500	10.0	11.9	14.9	19.9	29.9	1400	10.1	12.2	15.3	20.3	30.5	1400	11.6	14.0	17.5	23.3	35.0
0.0068	1500	9.4	11.3	14.0	18.8	28.1	1400	10.5	12.6	15.7	20.9	31.4	1400	10.7	12.6	16.1	21.4	32.1	1300	12.3	14.7	18.4	24.6	36.8
0.0075	1500	9.8	11.7	14.7	19.6	29.4	1400	11.0	13.1	16.5	21.9	32.8	1300	11.3	13.6	16.9	22.6	33.9	1300	12.9	15.5	19.4	25.9	38.9
0.0082	1400	10.3	12.4	15.4	20.6	31.0	1400	11.5	13.9	17.3	23.1	34.6	1300	11.9	14.2	17.9	23.8	35.6	1300	13.7	16.4	20.5	27.2	40.9
0.0091	1400	10.8	13.0	16.3	21.7	32.5	1300	12.1	14.5	18.1	24.2	36.4	1300	12.5	15.0	18.7	24.9	37.5	1300	14.3	17.2	21.5	28.6	43.0
0.010	1400	11.4	13.7	17.1	22.8	34.2	1300	12.7	15.3	19.2	25.5	38.2	1300	13.0	15.6	19.6	26.1	39.2	1300	15.2	18.1	22.7	30.2	45.4
0.012	1400	12.3	14.8	18.4	24.6	36.9	1300	13.8	16.5	20.6	27.5	41.3	1300	14.1	17.0	21.3	28.4	42.5	1200	16.5	19.7	24.6	32.8	49.3
0.015	1300	13.1	15.7	19.6	26.1	39.2	1300	14.6	17.6	21.9	29.3	43.9	1200	15.1	18.1	22.6	30.1	45.3	1200	17.5	21.0	26.2	35.0	52.5
0.018	1300	14.4	17.3	21.6	28.7	43.2	1200	16.1	19.3	24.1	32.2	48.3	1200	16.6	19.9	24.8	33.2	49.8	1200	19.3	23.1	28.8	38.4	53.9
0.022	1200	15.4	18.6	23.2	31.0	46.4	1200	17.3	20.7	25.9	34.6	51.9	1200	17.9	21.4	26.8	35.6	53.5	1100	20.5	24.6	30.7	40.9	55.8



Permissible AC Voltage VS Frequency Curves

CBB81 (PPS)

容许脉冲电流 VS 频率曲线图



■ 电容器规格尺寸表 CBB81 (PPS)											
容量 μ F	成品编码	外形尺寸 (mm)				容量 μ F	成品编码	外形尺寸 (mm)			
		Wmax	Tmax	Hmax	P±1			Wmax	Tmax	Hmax	P±1
1000VDC/1250VDC											
0.00033	PPS331KA130509###	13.0	5.0	9.0	10.0	0.0022	PPS222KA130611###	13.0	6.0	11.0	10.0
0.00039	PPS391KA130509###	13.0	5.0	9.0	10.0	0.0027	PPS272KA130611###	13.0	6.0	11.0	10.0
0.00047	PPS471KA130510###	13.0	5.0	10.0	10.0	0.0033	PPS332KA130611###	13.0	6.0	11.0	10.0
0.00056	PPS561KA130610###	13.0	6.0	10.0	10.0	0.0039	PPS392KA130611###	13.0	6.0	11.0	10.0
0.00068	PPS681KA130611###	13.0	6.0	11.0	10.0	0.0047	PPS472KA130610###	13.0	6.0	10.0	10.0
0.00082	PPS821KA130611###	13.0	6.0	11.0	10.0	0.0056	PPS562KA130711###	13.0	7.0	11.0	10.0
0.0010	PPS102KA130509###	13.0	5.0	9.0	10.0	0.0068	PPS682KA130610###	13.0	6.0	10.5	10.0
0.0012	PPS122KA130509###	13.0	5.0	9.0	10.0	0.0082	PPS822KA130611###	13.0	6.0	11.0	10.0
0.0015	PPS152KA130509###	13.0	5.0	9.0	10.0	0.01	PPS103KA130712###	13.0	7.0	12.0	10.0
0.0018	PPS182KA130509###	13.0	5.0	9.0	10.0						
1000VDC/1250VDC											
0.001	PPS102KB190510###	19.0	6.0	10.0	15.0	0.022	PPS223KB241422###	24.0	13.5	22.0	20.0
0.0012	PPS122KB190510###	19.0	6.0	10.5	15.0	0.027	PPS273KB241523###	24.0	15.0	23.5	20.0
0.0015	PPS152KB190611###	19.0	6.0	11.0	15.0	0.018	PPS183KB290917###	29.0	9.0	17.5	25.0
0.0018	PPS182KB190611###	19.0	6.5	11.5	15.0	0.022	PPS223KB291019###	29.0	10.5	19.0	25.0
0.0022	PPS222KB190712###	19.0	7.0	12.5	15.0	0.027	PPS273KB290918###	29.0	9.5	18.0	25.0
0.0027	PPS272KB190813###	19.0	8.0	13.0	15.0	0.033	PPS333KB291019###	29.0	10.5	19.0	25.0
0.0033	PPS332KB190914###	19.0	8.5	14.0	15.0	0.039	PPS393KB291120###	29.0	11.5	20.0	25.0
0.0039	PPS392KB190916###	19.0	8.5	15.5	15.0	0.047	PPS473KB291321###	29.0	12.5	21.0	25.0
0.0047	PPS472KB191017###	19.0	10.0	17.0	15.0	0.056	PPS563KB291422###	29.0	14.0	22.0	25.0
0.0056	PPS562KB191118###	19.0	11.0	17.5	15.0	0.068	PPS683KB291524###	29.0	15.0	23.5	25.0
0.0056	PPS562KB240713###	24.0	7.5	13.0	20.0	0.082	PPS823KB291725###	29.0	17.0	25.5	25.0
0.0068	PPS682KB190713###	19.0	7.0	12.5	15.0	0.1	PPS104KB341220###	35.0	11.5	20.0	30.0
0.0068	PPS682KB240815###	24.0	8.0	15.0	20.0	0.12	PPS124KB341321###	35.0	13.0	21.0	30.0
0.0082	PPS822KB190813###	19.0	8.0	13.5	15.0	0.15	PPS154KB341423###	35.0	14.5	23.0	30.0
0.0082	PPS822KB240916###	24.0	8.6	15.6	20.0	0.18	PPS184KB341525###	35.0	15.0	25.0	30.0
0.01	PPS103KB190815###	19.0	8.0	15.0	15.0	0.22	PPS224KB341727###	35.0	17.0	27.0	30.0
0.01	PPS103KB241016###	24.0	9.5	16.5	20.0	0.27	PPS274KB341929###	35.0	19.0	29.0	30.0
0.012	PPS123KB241117###	24.0	10.5	17.5	20.0	0.33	PPS334KB342131###	35.0	21.0	31.0	30.0
0.015	PPS153KB241219###	24.0	12.0	18.5	20.0	0.39	PPS394KB342333###	35.0	23.0	33.0	30.0
0.018	PPS183KB241221###	24.0	12.5	20.5	20.0	0.47	PPS474KB342635###	35.0	25.5	33.5	30.0
1600VDC											
0.001	PPS102KC190611###	19.0	6.5	11.5	15.0	0.015	PPS153KC241219###	24.0	12.0	18.5	20.0
0.0012	PPS122KC190712###	19.0	7.0	12.5	15.0	0.018	PPS183KC241221###	24.0	12.0	21.0	20.0
0.0015	PPS152KC190611###	19.0	6.0	11.0	15.0	0.022	PPS223KC241422###	24.0	13.5	22.0	20.0
0.0018	PPS182KC190611###	19.0	6.5	11.5	15.0	0.015	PPS153KC290817###	29.0	8.0	16.5	25.0
0.0022	PPS222KC190712###	19.0	7.0	12.5	15.0	0.018	PPS183KC290917###	29.0	9.0	17.5	25.0
0.0027	PPS272KC190813###	19.0	8.0	13.0	15.0	0.022	PPS223KC291019###	29.0	10.5	19.0	25.0
0.0033	PPS332KC190815###	19.0	8.0	15.0	15.0	0.027	PPS273KC291220###	29.0	11.5	20.0	25.0
0.0039	PPS392KC190916###	19.0	8.5	15.5	15.0	0.033	PPS333KC291321###	29.0	13.0	21.0	25.0
0.0047	PPS472KC191017###	19.0	10.0	17.0	15.0	0.039	PPS393KC291422###	29.0	14.0	22.5	25.0

■ 电容器规格尺寸表 CBB81 (PPS)

容量 μF	成品编码	外形尺寸 (mm)				容量 μF	成品编码	外形尺寸 (mm)			
		Wmax	Tmax	Hmax	P ± 1			Wmax	Tmax	Hmax	P ± 1
1600VDC											
0.0056	PPS562KC240714###**	24.0	7.5	14.5	20.0	0.047	PPS473KC291525###**	29.0	15.0	24.5	25.0
0.0068	PPS682KC240815###**	24.0	8.0	15.0	20.0	0.056	PPS563KC291626###**	29.0	16.5	26.0	25.0
0.0082	PPS822KC240916###**	24.0	9.0	16.0	20.0	0.068	PPS683KC291828###**	29.0	18.0	28.0	25.0
0.01	PPS103KC241016###**	24.0	9.5	16.5	20.0	0.082	PPS823KC351725###**	35.0	17.0	25.5	31.5
0.012	PPS123KC241117###**	24.0	10.0	17.5	20.0	0.1	PPS104KC351927###**	35.0	19.0	27.5	31.5
2000VDC											
0.00056	PPS561KD190612###**	19.0	6.5	11.5	15.0	0.0047	PPS472KD241118###**	24.0	11.0	18.0	20.0
0.00068	PPS681KD190713###**	19.0	7.5	13.0	15.0	0.0056	PPS562KD241117###**	24.0	11.0	18.0	20.0
0.00082	PPS821KD190813###**	19.0	8.0	13.5	15.0	0.0068	PPS682KD241119###**	24.0	11.5	19.5	20.0
0.001	PPS102KD190815###**	19.0	8.0	15.0	15.0	0.0082	PPS822KD241221###**	24.0	12.0	20.0	20.0
0.0012	PPS122KD190815###**	19.0	8.0	15.0	15.0	0.01	PPS103KD241221###**	24.0	12.5	20.5	20.0
0.0015	PPS152KD191016###**	19.0	9.5	16.0	15.0	0.012	PPS123KD241221###**	24.0	13.5	21.5	20.0
0.0018	PPS182KD191017###**	19.0	10.0	17.0	15.0	0.0047	PPS472KD290917###**	29.0	8.5	17.0	25.0
0.0022	PPS222KD191116###**	19.0	10.5	16.0	15.0	0.0056	PPS562KD291018###**	29.0	10.0	18.0	25.0
0.0027	PPS272KD240916###**	24.0	9.0	16.0	20.0	0.0068	PPS682KD291119###**	29.0	11.0	19.0	25.0
0.0033	PPS332KD240916###**	24.0	9.0	16.0	20.0	0.0082	PPS822KD291119###**	29.0	11.0	19.0	25.0
0.0039	PPS392KD241017###**	24.0	10.5	17.0	20.0	0.01	PPS103KD291119###**	29.0	12.0	21.0	25.0
3000VDC											
0.00033	PPS331KE190510###**	18.0	5.0	10.0	15.0	0.0022	PPS222KE240914###**	23.0	9.0	14.0	20.0
0.00039	PPS391KE190611###**	18.0	6.0	11.0	15.0	0.0027	PPS272KE241015###**	23.0	10.0	15.0	20.0
0.00047	PPS471KE190611###**	18.0	6.0	11.0	15.0	0.0033	PPS332KE241017###**	23.0	10.0	17.0	20.0
0.00056	PPS561KE190612###**	18.0	6.0	12.0	15.0	0.0039	PPS392KE290816###**	29.0	8.0	17.0	25.0
0.00068	PPS681KE190713###**	18.0	7.0	13.0	15.0	0.0047	PPS472KE290917###**	29.0	9.0	17.0	25.0
0.00082	PPS821KE190813###**	18.0	8.0	13.0	15.0	0.0056	PPS562KE291017###**	29.0	10.0	17.0	25.0
0.001	PPS102KE190914###**	18.0	9.0	14.0	15.0	0.0068	PPS682EF291219###**	29.0	12.0	19.0	25.0
0.0012	PPS122KE240712###**	23.0	7.0	12.0	20.0	0.0082	PPS822KE291321###**	29.0	13.0	21.0	25.0
0.0015	PPS152KE240813###**	23.0	8.0	13.0	20.0	0.0091	PPS912KE291321###**	29.0	13.0	21.0	25.0
0.0018	PPS182KE240814###**	23.0	8.0	14.0	20.0	0.01	PPS103KE291422###**	29.0	14.0	22.0	25.0