

3W, AC/DC converter

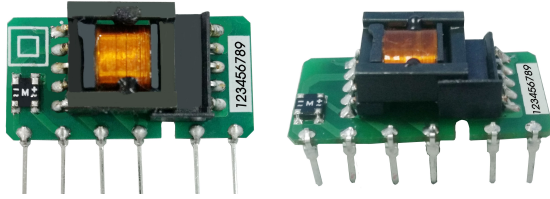

## FEATURES

- Ultra wide input voltage range: 85 - 305VAC/70 - 430VDC
- Output short circuit, over-current protection
- High efficiency, high power density
- Low power consumption, green power
- Industrial-grade design
- Open frame, compact size
- Flexible design of peripheral circuit reduces layout problems
- Meets IEC60950, UL60950, EN60950 standards (Pending)

LS03-15BxxSR2S (-F) series is a high efficiency green power modules provided by Mornsun. The features of this series are: Accept either AC or DC input, wide input voltage, high efficiency, low power consumption, safety isolation etc. All models are particularly suitable for the applications such as industrial, electric power, instrumentation, smart home which do not have high requirement on EMC. EMC application circuit must be added if the products need to be applied to EMC harsh environment .

## Selection Guide

Certification	Part No.	Output Power	Nominal Output Voltage and Current(Vo/Io)	Efficiency (230VAC, %/Typ.)	Max. Capacitive Load (uF)
UL/CE/CB (Pending)	LS03-15B03SR2S(-F)*	3W	3.3V/600mA	65	820
	LS03-15B05SR2S(-F)		5V/600mA	70	680
	LS03-15B09SR2S(-F)		9V/333mA	73	470
	LS03-15B12SR2S(-F)		12V/250mA	74	470
	LS03-15B15SR2S(-F)		15V/200mA	75	330
	LS03-15B24SR2S(-F)		24V/125mA	77	100

Note: \*The model of 90 degrees of corner is with -F. For example the LS03-15B03SR2S of 90 degrees of corner product is LS03-15B03SR2S-F.

## Input Specifications

Item	Operating Conditions	Min.	Typ.	Max.	Unit
Input Voltage Range	AC input	85	--	305	VAC
	DC input	70	--	430	VDC
Input frequency		47	--	63	Hz
Input current	115VAC	--	--	0.12	A
	277VAC	--	--	0.06	
Inrush current	115VAC	--	13	--	
	277VAC	--	23	--	
Recommended External Input Fuse		1A, slow fusing, necessary			
Hot Plug		Unavailable			

## Output Specifications

Item	Operating Conditions	Min.	Typ.	Max.	Unit
Output Voltage Accuracy	LS03-15B03SR2S(-F) <sup>①</sup>	--	--	±6	%
	LS03-15B05SR2S(-F) <sup>②</sup>	--	--	±5	
	LS03-15B09SR2S(-F) <sup>③</sup>	--	--		
	LS03-15B12SR2S(-F) <sup>④</sup>	--	--		
	LS03-15B15SR2S(-F)	--	--		
	LS03-15B24SR2S(-F)	--	--		
Line Regulation	Full load	3.3V	--	±2.5	--
		5V/9V/12V/15V/24V	--	±1.5	--
Load Regulation	10% - 100% load	--	±2.5	--	
Ripple & Noise <sup>⑤</sup>	20MHz bandwidth (peak-peak value)	--	80	150	mV

Temperature Coefficient		--	±0.15	--	%/°C
Stand-by Power Consumption	230VAC input	--	0.15	0.25	W
Short Circuit Protection		Continuous, self-recovery			
Over-current Protection		110 - 500%Io, self-recovery			
Min. Load		10	--	--	%
Note: ①②③④ When 3.3V/5V/9V/12V working in -20°C to -40°C temperature range output filter capacitor C2 need 270μF/16V solid-state capacitor. ⑤ Ripple and noise are measured by "parallel cable" method, please see AC-DC Converter Application Notes for specific operation.					

### General Specifications

Item	Operating Conditions	Min.	Typ.	Max.	Unit
Isolation Voltage	Input-output	3000	--	--	VAC
Operating Temperature		-40	--	+85	°C
Storage Temperature		-40	--	+105	
Storage Humidity		--	--	85	%RH
Switching Frequency		--	--	65	kHz
Power Derating	-40°C to -20°C (85 - 110VAC)	2.0	--	--	% / °C
	+70°C to +85°C	2.67	--	--	
Safety Standard		IEC60950/EN60950/UL60950			
Safety Certification		IEC60950/EN60950/UL60950 (Pending)			
Safety Class		CLASS II			
MTBF	MIL-HDBK-217F@25°C	>300,000 h			

### Physical Specifications

Package Dimensions	35.00*18.00*11.00 mm
Weight	6g (Typ.)
Cooling method	Free air convection

### EMC Specifications

EMI	CE	CISPR22/EN55022	CLASS A (See Fig. 1 for typical application circuit)	
		CISPR22/EN55022	CLASS B (See Fig. 2 for recommended circuit)	
	RE	CISPR22/EN55022	CLASS A (See Fig. 1 for typical application circuit)	
		CISPR22/EN55022	CLASS B (See Fig. 2 for recommended circuit)	
EMS	ESD	IEC/EN61000-4-2	Contact ±4KV	Perf. Criteria B
	RS	IEC/EN61000-4-3	10V/m (See Fig. 2 for recommended circuit)	perf. Criteria A
	EFT	IEC/EN61000-4-4	±2KV (See Fig. 1 for typical application circuit)	perf. Criteria B
		IEC/EN61000-4-4	±4KV (See Fig. 2 for recommended circuit)	perf. Criteria B
	Surge	IEC/EN61000-4-5	line to line ±1KV (See Fig. 1 for typical application circuit)	perf. Criteria B
		IEC/EN61000-4-5	line to line±1KV/line to ground ±2KV (See Fig. 2 for recommended circuit)	perf. Criteria B
	CS	IEC/EN61000-4-6	10Vr.m.s (See Fig. 2 for recommended circuit)	perf. Criteria A
Voltage dips, short interruptions and voltage variations immunity	IEC/EN61000-4-11	0%, 70% (See Fig. 2 for recommended circuit)	perf. Criteria B	

### Product Characteristic Curve

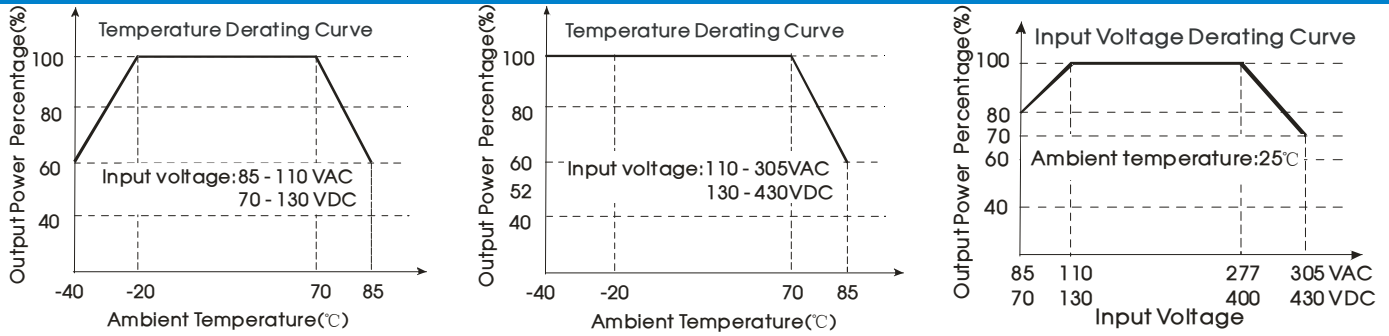

Note:

- ① Input voltage should be derated based on temperature derating when it is 85 - 110VAC/277 - 305VAC/70 - 130VDC/400 - 430VDC;
- ② This product is suitable for use in natural air cooling environments, if in a closed environment, please contact our company's FAE.

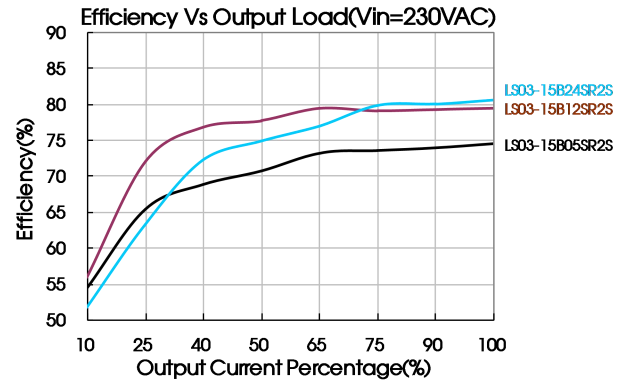
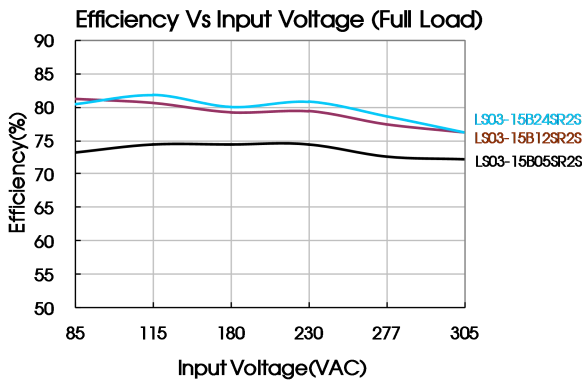

### Design Reference

#### 1. Typical application circuit

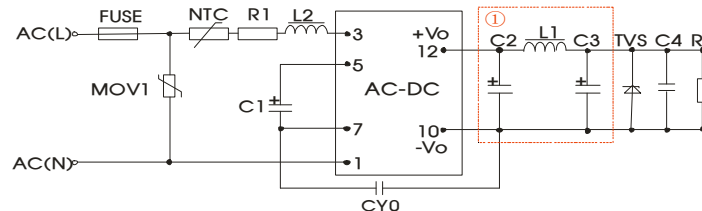

Fig. 1

Note: ① is PI filter circuit.

Model	FUSE (necessary)	C1 (necessary)	L2	NTC	C2 (necessary)	L1 (necessary)	C3 (necessary)	C4	CY0	TVS	
LS03-15B03SR2S(-F)	1A/ 300V	10μF/450V (-20°C to +85°C) 22μF/450V (-40°C to +85°C)	4.7mH	13D-5	270μF/ 16V (Solid Capacitor)	4.7μH	120μF/25V	0.1μF/ 50V	1nF/400 VAC	SMBJ7.0A	
LS03-15B05SR2S(-F)							47μF/35V			SMBJ12A	
LS03-15B09SR2S(-F)										47μF/35V	SMBJ20A
LS03-15B12SR2S(-F)											SMBJ30A
LS03-15B15SR2S(-F)										220μF/ 35V	
LS03-15B24SR2S(-F)											

- Note:
- C1: AC input, C1 is input filter capacitor (which is required);
  - DC input, is a filtering capacitor in EMC Filter (which is required);
  - R1: Limit current resistance, the value of R1 is 12Ω, 2W; If the capacitance value of C1 ≥ 22μF, you can not take;
  - C2 and C3 are output filter capacitors (which is required), C2, C3 and L1 form a pi-type filter circuit, they are recommended to be high frequency and low impedance electrolytic capacitors. Capacitance and rated ripple current of capacitors refer to the datasheets provided by the manufactures. Capacitor voltage reduced to at least 80%. C4 is a ceramic capacitor, which is used to filter high frequency noise. Current of L1 and L2 refer to the datasheets provided by the manufactures, current derating to at least 80%. TVS is a recommended component to protect post-circuits (if converter fails). External input NTC model is recommended to use 13D-5. External input MOV model is recommended to use S14K350.

2. EMC solution-recommended circuit

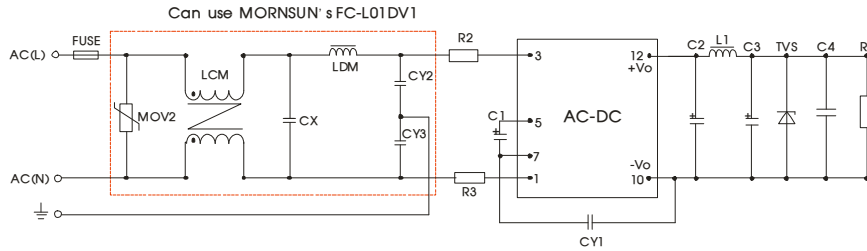

Fig 2

Components	Recommend Parameter
MOV2	S14K350
CY1	2.2nF/400VAC
CY2/CY3	1nF/400VAC
CX	0.1μF/310VAC
LCM	3.50mH
LDM	0.33mH
R2/R3	12 Ω /2W
FUSE (necessary)	1A/300V, slow fusing

Can use MORNSUN's FC-L01DV1 EMC model

3. For more information Please find the application note on [www.mornsun-power.com](http://www.mornsun-power.com)

LS03-15BxxSR2S Dimensions and Recommended Layout

THIRD ANGLE PROJECTION

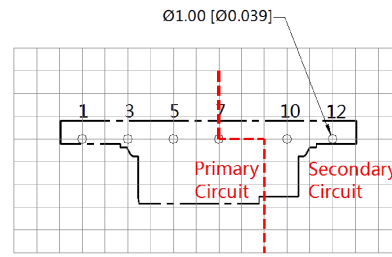
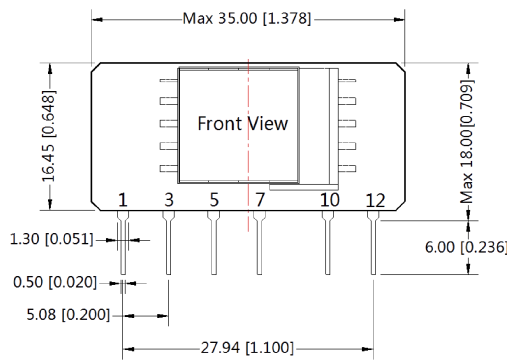

Note:Grid 2.54\*2.54mm

Pin-Out	
Pin	Function
1	AC ( N )
3	AC ( L )
5	+V(cap)
7	-V(cap)
10	-Vo
12	+Vo

Note:  
Unit: mm[inch]  
Pin section tolerances: ±0.10[±0.004]  
General tolerances: ±0.50[±0.020]  
The layout of the device is for reference only , please refer to the actual product

- 1.It is necessary to add C1 between pin5 and pin7 ;
- 2.It is necessary to add pi-type filter circuit to the output,such as the typical application of Figure 1;
- 3.It is needed to have distance ≥6.4mm for safety between external componets in primary circuit and secondary circuit.

LS03-15BxxSR2S -F Dimensions and Recommended Layout

THIRD ANGLE PROJECTION 

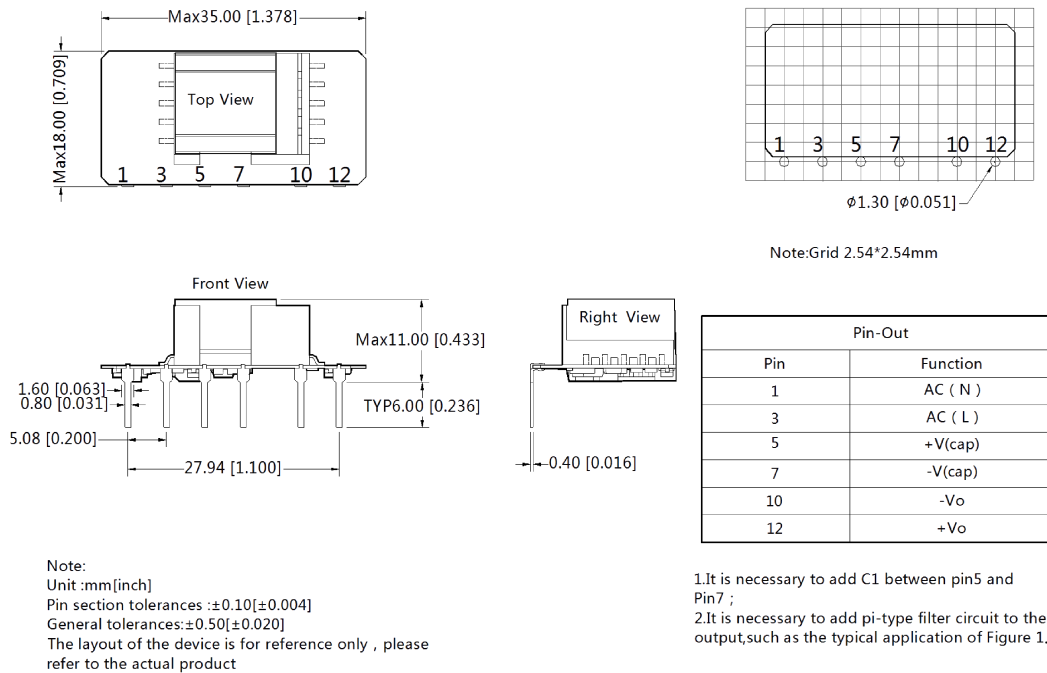

Note:

1. Packing information please refer to Product Packing Information which can be downloaded from [www.mornsun-power.com](http://www.mornsun-power.com). Packing bag number: 58220032(LS03-15BxxSR2S)/58220025 (LS03-15BxxSR2S-F);
2. External electrolytic capacitors are required to modules, more details refer to typical applications;
3. This part is open frame, at least 6.4mm safety distance between the primary and secondary external components of the module is needed to meet the safety requirement;
4. Unless otherwise specified, parameters in this datasheet were measured under the conditions of  $T_a=25^{\circ}\text{C}$ , humidity<75%, nominal input voltage (115V and 230V) and rated output load;
5. In order to increase the conversion efficiency of the product with light load in the design, the product will have audio noise when it is operating, but don't affect the product's reliability and performance;
6. Module required dispensing fixed after assembled;
7. All index testing methods in this datasheet are based on our Company's corporate standards;
8. We can provide product customization service, please contact our technicians directly for specific information;
9. Specifications are subject to change without prior notice.

Mornsun Guangzhou Science & Technology Co., Ltd.

Address: No. 5, Kehui St. 1, Kehui Development Center, Science Ave., Guangzhou Science City, Luogang District, Guangzhou, P. R. China  
Tel: 86-20-38601850-8801 Fax: 86-20-38601272 E-mail: info@mornsun.cn