



**MPSA44/45**

**NPN SILICON TRANSISTOR**

**HIGH VOLTAGE TRANSISTOR**

■ **FEATURES**

- \* Collector-Emitter Voltage:  
 $V_{CE0}=400V$  (UTC **MPSA44**)  
 $V_{CE0}=350V$  (UTC **MPSA45**)
- \* Collector Current up to 300mA

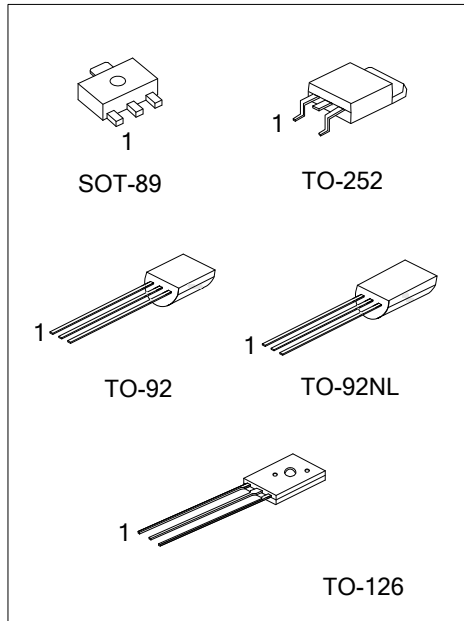

■ **ORDERING INFORMATION**

Ordering Number		Package	Pin Assignment			Packing
Lead Free	Halogen Free		1	2	3	
-	MPSA44G-AB3-R	SOT-89	B	C	E	Tape Reel
MPSA44L-AN3-R	MPSA44G-TN3-R	TO-252	B	C	E	Tape Reel
MPSA44L-T60-K	MPSA44G-T60-K	TO-126	B	C	E	Bulk
MPSA44L-T92-B	MPSA44G-T92-B	TO-92	E	B	C	Tape Box
MPSA44L-T92-K	MPSA44G-T92-K	TO-92	E	B	C	Bulk
MPSA44L-T92-A-B	MPSA44G-T92-A-B	TO-92	E	C	B	Tape Box
MPSA44L-T92-A-K	MPSA44G-T92-A-K	TO-92	E	C	B	Bulk
MPSA44L-T9N-B	MPSA44G-T9N-B	TO-92NL	E	B	C	Tape Box
MPSA44L-T9N-K	MPSA44G-T9N-K	TO-92NL	E	B	C	Bulk
-	MPSA45G-AB3-R	SOT-89	B	C	E	Tape Reel
MPSA45L-T92-B	MPSA45G-T92-B	TO-92	E	B	C	Tape Box
MPSA45L-T92-K	MPSA45G-T92-K	TO-92	E	B	C	Bulk
MPSA45L-T9N-B	MPSA45G-T9N-B	TO-92NL	E	B	C	Tape Box
MPSA45L-T9N-K	MPSA45G-T9N-K	TO-92NL	E	B	C	Bulk

Note: Pin Assignment: C: Collector B: Base E: Emitter

<p>MPSA44L-T92-A-R</p>	<p>(1) Packing Type                  (2) refer to Pin Assignment                  (3) AB3: SOT-89, TN3: TO-252, T60: TO-126, T92: TO-92, T9N: TO-92NL                  (4) G: Halogen Free and Lead Free, L: Lead Free</p>
------------------------	--

## MARKING

Package	MPSA44	MPSA45
SOT-89		
TO-252		
TO-126		
TO-92		
TO-92NL		

## ■ ABSOLUTE MAXIMUM RATING

PARAMETER		SYMBOL	RATINGS	UNIT
Collector-Base Voltage	MPSA44	$V_{CB0}$	500	V
	MPSA45		400	
Collector-Emitter Voltage	MPSA44	$V_{CE0}$	400	V
	MPSA45		350	
Emitter-Base Voltage		$V_{EBO}$	6	V
Collector Current		$I_C$	300	mA
Collector Dissipation	SOT-89	$P_C$	500	mW
	TO-252		1400	
	TO-126		1200	
	TO-92		625	
Junction Temperature		$T_J$	125	°C
Operating Temperature		$T_{OPR}$	-20 ~ +85	°C
Storage Temperature		$T_{STG}$	-40 ~ +150	°C

Note: Absolute maximum ratings are those values beyond which the device could be permanently damaged. Absolute maximum ratings are stress ratings only and functional device operation is not implied.

## ■ ELECTRICAL CHARACTERISTICS ( $T_J=25^\circ\text{C}$ , unless otherwise specified)

PARAMETER		SYMBOL	TEST CONDITIONS	MIN	TYP	MAX	UNIT
Collector-Base Breakdown Voltage	MPSA44	$BV_{CB0}$	$I_C=100\mu\text{A}, I_E=0$	500			V
	MPSA45			400			
Collector-Emitter Breakdown Voltage	MPSA44	$BV_{CE0}$	$I_C=1\text{mA}, I_B=0$	400			V
	MPSA45			350			
Emitter-Base Breakdown Voltage		$BV_{EBO}$	$I_E=100\mu\text{A}, I_C=0$	6			V
Collector Cutoff Current	MPSA44	$I_{CB0}$	$V_{CB}=400\text{V}, I_E=0$			0.1	$\mu\text{A}$
	MPSA45		$V_{CB}=320\text{V}, I_E=0$			0.1	
Collector Cutoff Current	MPSA44	$I_{CE0}$	$V_{CE}=400\text{V}, I_B=0$			0.5	$\mu\text{A}$
	MPSA45		$V_{CE}=320\text{V}, I_B=0$			0.5	
Emitter Cutoff Current		$I_{EBO}$	$V_{EB}=4\text{V}, I_C=0$			0.1	$\mu\text{A}$
<b>ON CHARACTERISTICS</b>							
DC Current Gain (Note)		$h_{FE}$	$V_{CE}=10\text{V}, I_C=1\text{mA}$	40		240	
			$V_{CE}=10\text{V}, I_C=10\text{mA}$	82		240	
			$V_{CE}=10\text{V}, I_C=50\text{mA}$	45		240	
			$V_{CE}=10\text{V}, I_C=100\text{mA}$	40		240	
Collector-Emitter Saturation Voltage		$V_{CE(SAT)}$	$I_C=1\text{mA}, I_B=0.1\text{mA}$			0.4	V
			$I_C=10\text{mA}, I_B=1\text{mA}$			0.5	
			$I_C=50\text{mA}, I_B=5\text{mA}$			0.75	
Base-Emitter Saturation Voltage		$V_{BE(SAT)}$	$I_C=10\text{mA}, I_B=1\text{mA}$			0.75	V
<b>SMALL-SIGNAL CHARACTERISTICS</b>							
Current Gain Bandwidth Product		$f_T$	$V_{CE}=20\text{V}, I_C=10\text{mA}, f=100\text{MHz}$	50			MHz
Output Capacitance		$C_{OB}$	$V_{CB}=20\text{V}, I_E=0, f=1\text{MHz}$			7	pF

Note: Pulse test:  $PW < 300\mu\text{s}$ , Duty Cycle  $< 2\%$

## TYPICAL CHARACTERISTICS

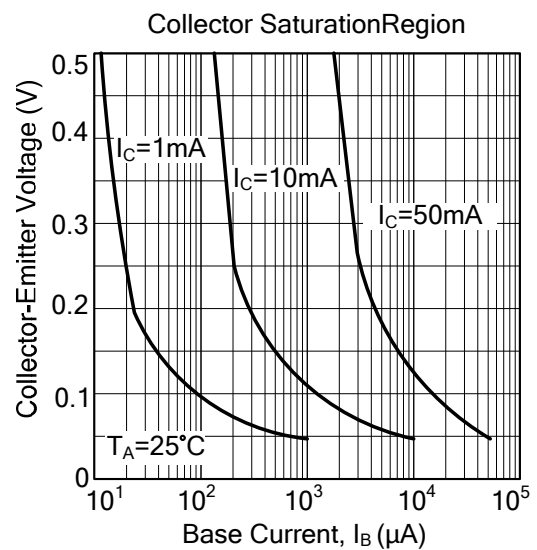
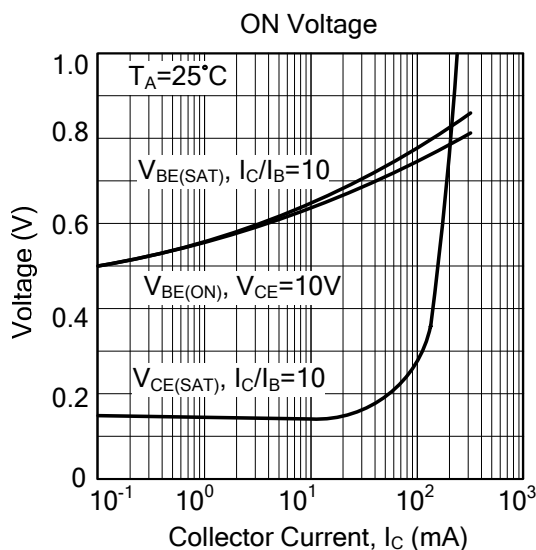
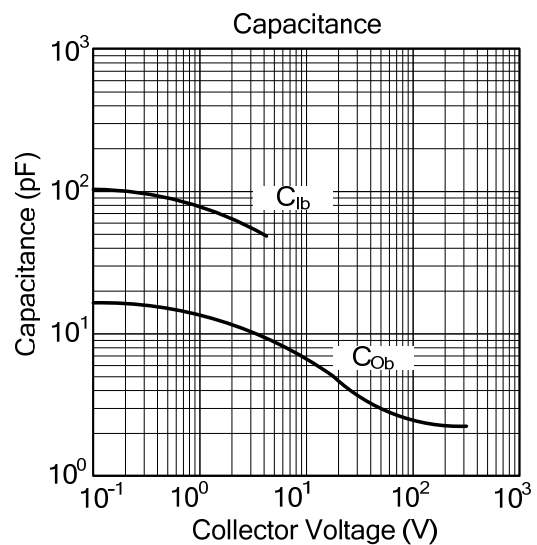
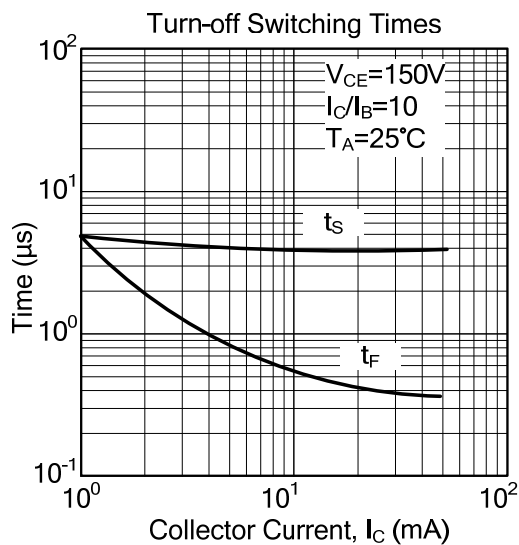
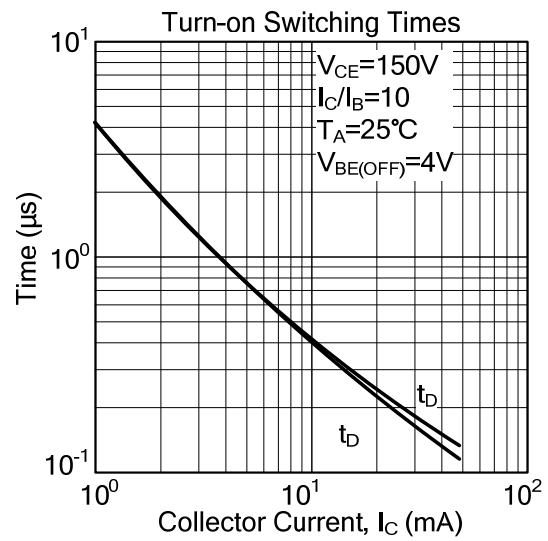
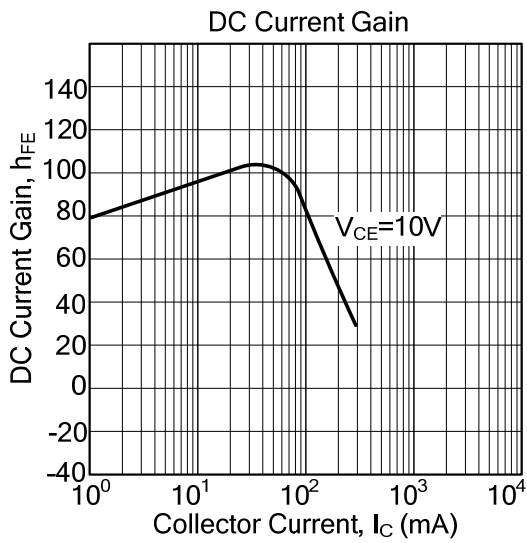

■ TYPICAL CHARACTERISTICS(Cont.)

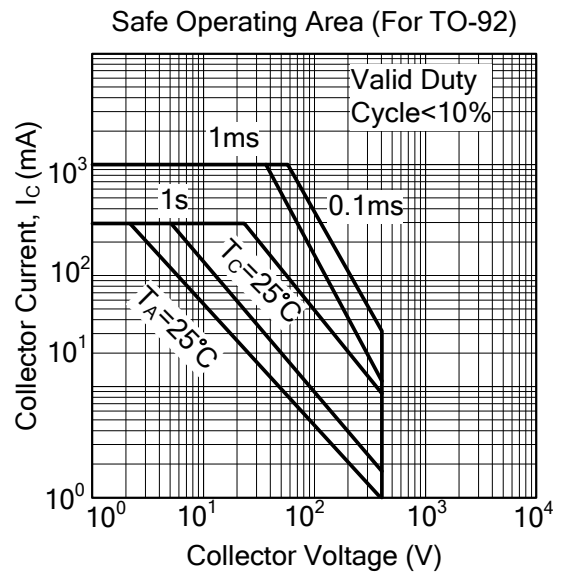
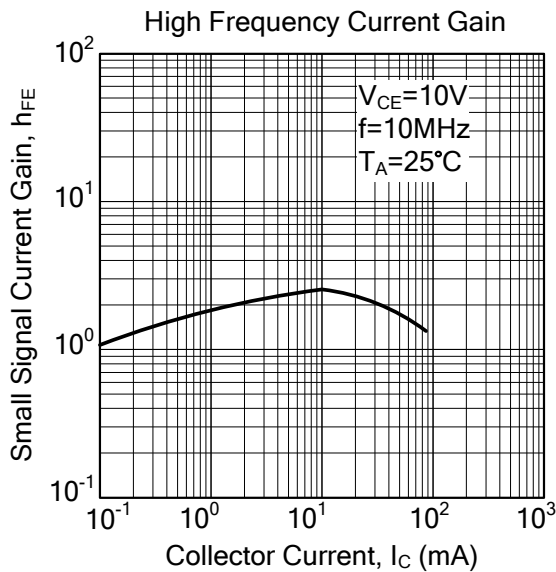

UTC assumes no responsibility for equipment failures that result from using products at values that exceed, even momentarily, rated values (such as maximum ratings, operating condition ranges, or other parameters) listed in products specifications of any and all UTC products described or contained herein. UTC products are not designed for use in life support appliances, devices or systems where malfunction of these products can be reasonably expected to result in personal injury. Reproduction in whole or in part is prohibited without the prior written consent of the copyright owner. The information presented in this document does not form part of any quotation or contract, is believed to be accurate and reliable and may be changed without notice.