

Features

- Internal Frequency Compensation for Unity Gain
- High DC Voltage Gain: 110dB(Typ)
- Wide Bandwidth at Unity Gain: 1.2MHz(Typ)
- Wide Power Supply Range: 3V to 36V
- Dual Supplies: $\pm 1.5V$ to $\pm 18V$
- EMIRR IN+: 71dB(Under 1GHz)
- Low Supply Current: 100 μA (Typ)
- Offset Voltage Temperature Drift: 1 $\mu V/^{\circ}C$
- Input Bias Current: 60pA Typical
- Input Common-Mode Voltage Range Includes Ground
- Rail-to-Rail Output
- No Phase Reversal for Overdriven Inputs
- $-40^{\circ}C$ to $125^{\circ}C$ Operation Range
- ESD Rating: Robust 2KV – HBM, 2KV – CDM
- High Performance Drop-In Compatible With 321, 358, 324 Series Product

Applications

- Walkie-Talkie
- Battery Management Solution
- Transducer Amplifiers
- Summing Amplifiers
- Multivibrators
- Oscillators
- DC Gain Blocks

Description

LM321/358/324 types consist of single/dual/quad channel independent, high gain, internally frequency compensated operational amplifiers which are designed specifically to operate from a single power supply over a wide range of voltages. They may also be operated from split power supplies. The supply current is basically independent of the supply voltage over the recommended voltage range.

These devices are particularly useful in interface circuits with digital systems and can be operated from the single common 5V_{DC} power supply. They are also intended for transducer amplifiers, DC gain blocks and many other conventional op amp circuits which can benefit from the single power supply capability.

In the linear mode, the input common-mode voltage range includes ground and the output voltage can also swing to both ground and power rail, even though operated from a single power supply.

The LM321 is single channel version available in 5-pin SOT23 packages. The LM358 is dual channel version available in 8-pin SOP and MSOP packages. The LM324 is quad channel version available in 14-pin SOP and TSSOP packages.

3PEAK and the 3PEAK logo are registered trademarks of 3PEAK INCORPORATED. All other trademarks are the property of their respective owners.

Pin Configuration (Top View)

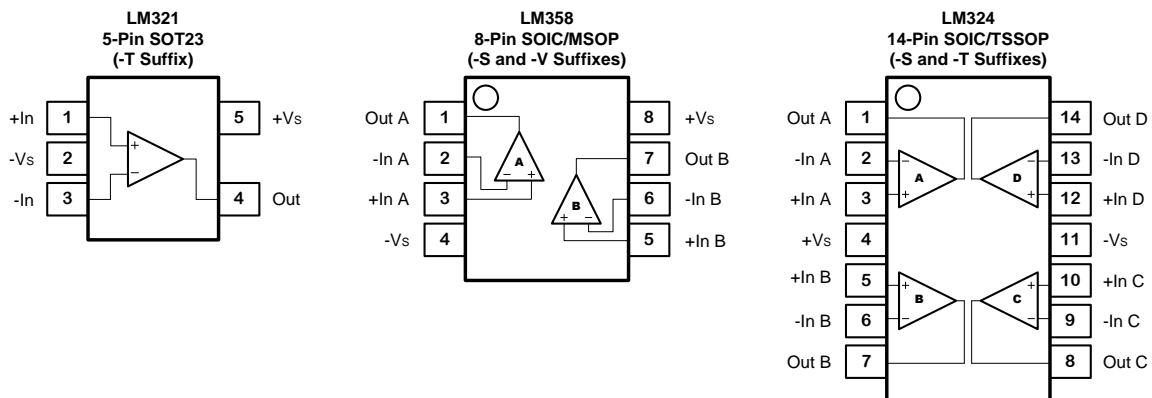

LM321 / LM358 / LM324

1.2MHz, Low-Power 36V Op Amps

Order Information

| Model Name | Order Number | Package | Transport Media, Quantity | Marking Information |
|------------|--------------|--------------|---------------------------|---------------------|
| LM321 | LM321-TR | 5-Pin SOT23 | Tape and Reel, 3,000 | H21 |
| LM358 | LM358-SR | 8-Pin SOP | Tape and Reel, 4,000 | LM358 |
| | LM358-VR | 8-Pin MSOP | Tape and Reel, 3,000 | LM358 |
| LM324 | LM324-SR | 14-Pin SOP | Tape and Reel, 2,500 | LM324 |
| | LM324-TR | 14-Pin TSSOP | Tape and Reel, 3,000 | LM324 |

Absolute Maximum Ratings Note 1

Supply Voltage: $V^+ - V^-$ Note 2..... 42V
Input Voltage..... $V^- - 0.3$ to $V^+ + 0.3$
Input Current: $+IN, -IN$ Note 3..... ± 20 mA
Differential Input Voltage..... ± 42 V
Output Short-Circuit Duration Note 4..... Infinite

Current at Supply Pins..... ± 60 mA
Operating Temperature Range..... -40°C to 125°C
Maximum Junction Temperature..... 150°C
Storage Temperature Range..... -65°C to 150°C
Lead Temperature (Soldering, 10 sec) 260°C

Note 1: Stresses beyond those listed under Absolute Maximum Ratings may cause permanent damage to the device. Exposure to any Absolute Maximum Rating condition for extended periods may affect device reliability and lifetime.

Note 2: The op amp supplies must be established simultaneously, with, or before, the application of any input signals.

Note 3: The inputs are protected by ESD protection diodes to each power supply. If the input extends more than 500mV beyond the power supply, the input current should be limited to less than 10mA.

Note 4: A heat sink may be required to keep the junction temperature below the absolute maximum. This depends on the power supply voltage and how many amplifiers are shorted. Thermal resistance varies with the amount of PC board metal connected to the package. The specified values are for short traces connected to the leads.

ESD, Electrostatic Discharge Protection

| Symbol | Parameter | Condition | Minimum Level | Unit |
|--------|--------------------------|----------------------------|---------------|------|
| HBM | Human Body Model ESD | MIL-STD-883H Method 3015.8 | 2 | kV |
| CDM | Charged Device Model ESD | JEDEC-EIA/JESD22-C101E | 2 | kV |

Thermal Resistance

| Package Type | θ_{JA} | θ_{JC} | Unit |
|--------------|---------------|---------------|---------------------------|
| 5-Pin SOT23 | 250 | 81 | $^\circ\text{C}/\text{W}$ |
| 8-Pin SOP | 158 | 43 | $^\circ\text{C}/\text{W}$ |
| 8-Pin MSOP | 210 | 45 | $^\circ\text{C}/\text{W}$ |
| 14-Pin SOP | 120 | 36 | $^\circ\text{C}/\text{W}$ |
| 14-Pin TSSOP | 180 | 35 | $^\circ\text{C}/\text{W}$ |

Electrical Characteristics

The specifications are at $T_A = 27^\circ\text{C}$. $V_S = 5\text{V}$, $V_{CM} = V_{OUT} = 2.5\text{V}$, $R_L = 2\text{k}\Omega$, $C_L = 100\text{pF}$. Unless otherwise noted.

| SYMBOL | PARAMETER | CONDITIONS | MIN | TYP | MAX | UNITS |
|--------------|---|---|-------|---------|-----------|------------------------------|
| V_{OS} | Input Offset Voltage | $V_S = 5\text{V}$, $V_{CM} = 2.5\text{V}$ and $V_{CM} = 0\text{V}$ | -3 | ± 1 | 3 | mV |
| | | $V_S = 30\text{V}$, $V_{CM} = 15\text{V}$ and $V_{CM} = 0\text{V}$ | -3 | ± 1 | 3 | mV |
| $V_{OS\ TC}$ | Input Offset Voltage Drift | -40°C to 125°C | | 1 | | $\mu\text{V}/^\circ\text{C}$ |
| I_B | Input Bias Current | $T_A = 27^\circ\text{C}$ | | 60 | | pA |
| | | $T_A = 85^\circ\text{C}$ | | 200 | | pA |
| I_{OS} | Input Offset Current | | | 0.001 | | pA |
| V_n | Input Voltage Noise | $f = 0.1\text{Hz}$ to 10Hz | | 10 | | μV_{PP} |
| e_n | Input Voltage Noise Density | $f = 1\text{kHz}$ | | 48 | | $\text{nV}/\sqrt{\text{Hz}}$ |
| i_n | Input Current Noise | $f = 1\text{kHz}$ | | 2 | | $\text{fA}/\sqrt{\text{Hz}}$ |
| C_{IN} | Input Capacitance | Differential | | 2.5 | | pF |
| | | Common Mode | | 5 | | |
| CMRR | Common Mode Rejection Ratio | DC, $V_{CM} = 0\text{V}$ to 28V | 80 | 120 | | dB |
| V_{CM} | Common-mode Input Voltage Range | $V_S = 5\text{V}$ to 30V | V- | | $V^+ - 2$ | V |
| PSRR | Power Supply Rejection Ratio | $V_S = 5\text{V}$ to 30V | 90 | 120 | | dB |
| A_{VOL} | Open-Loop Large Signal Gain | $V_S = 15\text{V}$, $V_O = 1\text{V}$ to 11V , $R_L = 2\text{k}\Omega$ | 98 | 110 | | dB |
| V_{OH} | Output Swing from Supply Rail | $R_{LOAD} = 10\text{k}\Omega$, $V_S = \pm 15\text{V}$ | 14.70 | 14.75 | | V |
| | | $R_{LOAD} = 2\text{k}\Omega$, $V_S = \pm 15\text{V}$ | 13.70 | 13.90 | | V |
| V_{OL} | Output Swing from Supply Rail | $R_{LOAD} = 10\text{k}\Omega$, $V_S = \pm 15\text{V}$ | | -14.85 | -14.70 | V |
| | | $R_{LOAD} = 2\text{k}\Omega$, $V_S = \pm 15\text{V}$ | | -14.25 | -14.10 | V |
| | | $R_{LOAD} \geq 10\text{k}\Omega$, $V_S = 15\text{V}$ | | 5 | | mV |
| R_{OUT} | Closed-Loop Output Impedance | $G = 1$, $f = 1\text{kHz}$, $I_{OUT} = 0$ | | 0.002 | | Ω |
| R_O | Open-Loop Output Impedance | $f = 1\text{kHz}$, $I_{OUT} = 0$ | | 120 | | Ω |
| I_{SC} | Output Short-Circuit Current | Sink or source current, $V_S = 30\text{V}$ | 20 | 35 | | mA |
| V_S | Supply Voltage | | 3 | | 36 | V |
| I_Q | Quiescent Current per Amplifier | $V_S = 5\text{V}$, No load | | 100 | 150 | μA |
| | | $V_S = 30\text{V}$, No load | | 110 | 200 | μA |
| PM | Phase Margin | $R_{LOAD} = 1\text{k}\Omega$, $C_{LOAD} = 100\text{pF}$ | | 62 | | $^\circ$ |
| GM | Gain Margin | $R_{LOAD} = 1\text{k}\Omega$, $C_{LOAD} = 60\text{pF}$ | | 18 | | dB |
| GBWP | Gain-Bandwidth Product | $f = 1\text{kHz}$ | | 1.2 | | MHz |
| SR | Slew Rate at unity gain | $A_V = 1$, $V_{OUT} = -10\text{V}$ to 10V , $C_{LOAD} = 60\text{pF}$, $R_{LOAD} = 10\text{k}\Omega$, $V_S = \pm 15\text{V}$ | | 0.55 | | $\text{V}/\mu\text{s}$ |
| FPBW | Full Power Bandwidth ^{Note 1} | | | 17.5 | | kHz |
| t_s | Settling Time, 0.1% Settling Time, 0.01% | $A_V = 1.5\text{V}$ to 3.5V Step | | 2.8 | | μs |
| | | | | 3.1 | | |
| THD+N | Total Harmonic Distortion and Noise | $f = 1\text{kHz}$, $A_V = 1$, $R_L = 2\text{k}\Omega$, $V_{OUT} = 1\text{V}_{p-p}$ | | 0.001 | | % |
| X_{talk} | Channel Separation | $f = 1\text{kHz}$ to 20kHz | | 80 | | dB |

Note 1: Full power bandwidth is calculated from the slew rate $FPBW = SR/\pi \cdot V_{P-P}$

1.2MHz, Low-Power 36V Op Amps

Typical Performance Characteristics

$V_S = \pm 15V$, $V_{CM} = 0V$, $R_L = \text{Open}$, unless otherwise specified.

Offset Voltage Production Distribution

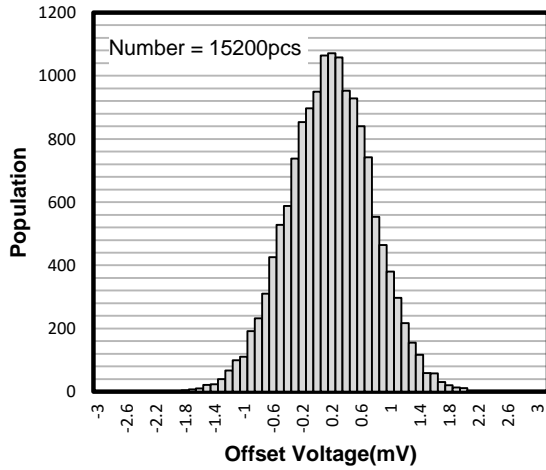

Unity Gain Bandwidth vs. Temperature

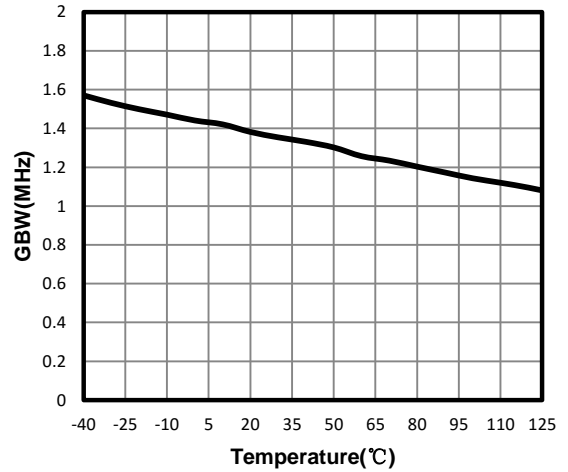

Open-Loop Gain and Phase

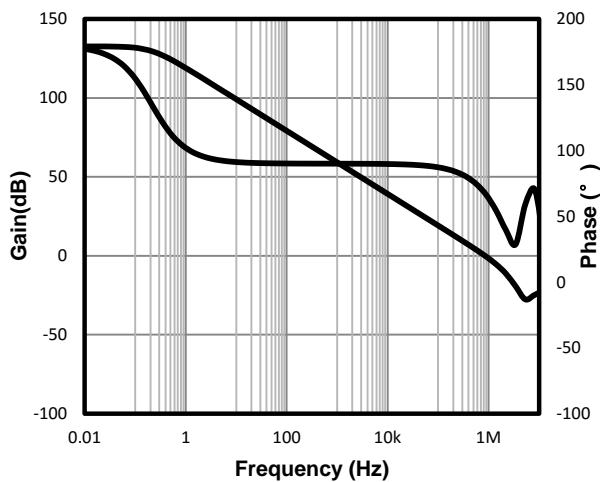

Input Voltage Noise Spectral Density

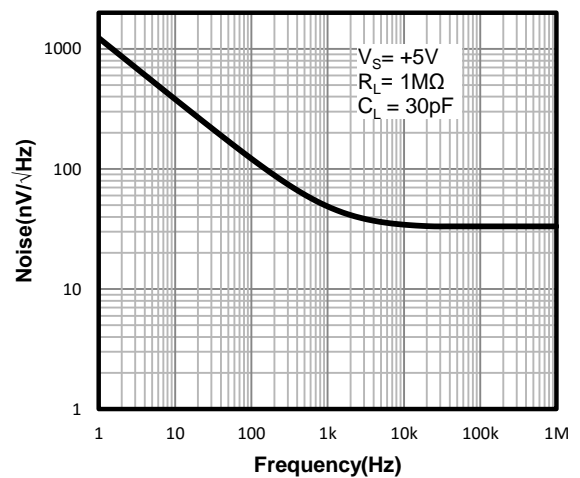

Input Bias Current vs. Temperature

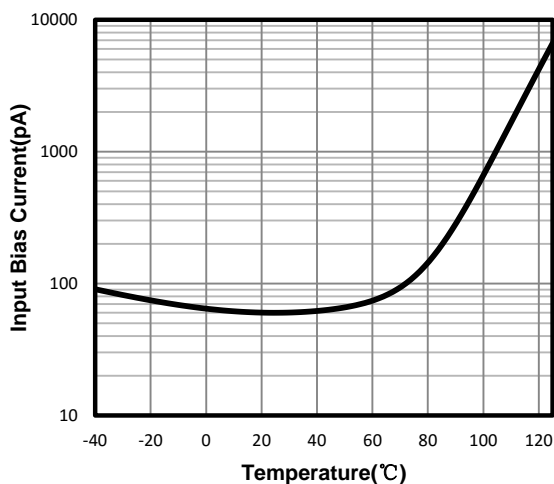

Input Bias Current vs. Input Common Mode Voltage

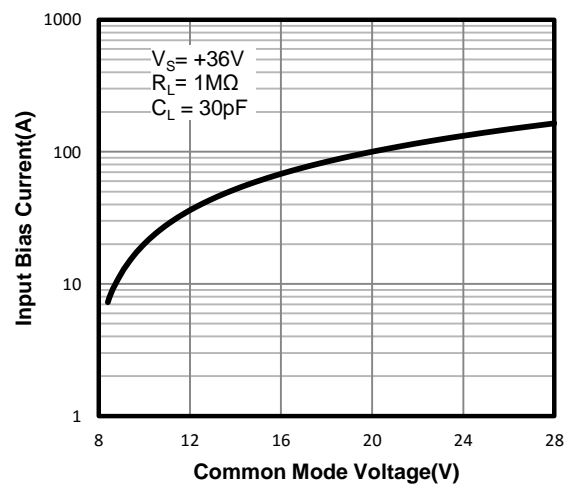

Typical Performance Characteristics

$V_S = \pm 15V$, $V_{CM} = 0V$, $R_L = \text{Open}$, unless otherwise specified. (Continued)

Common Mode Rejection Ratio

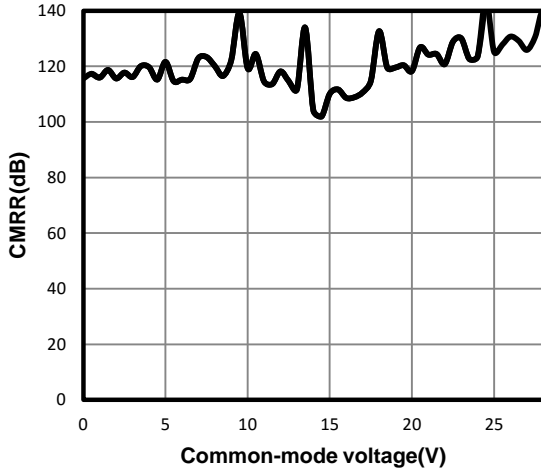

CMRR vs. Frequency

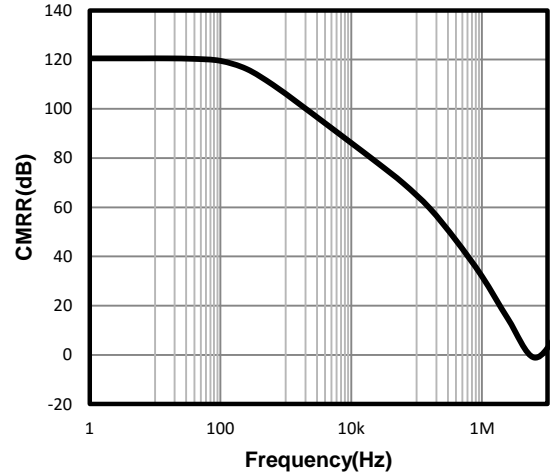

Quiescent Current vs. Temperature

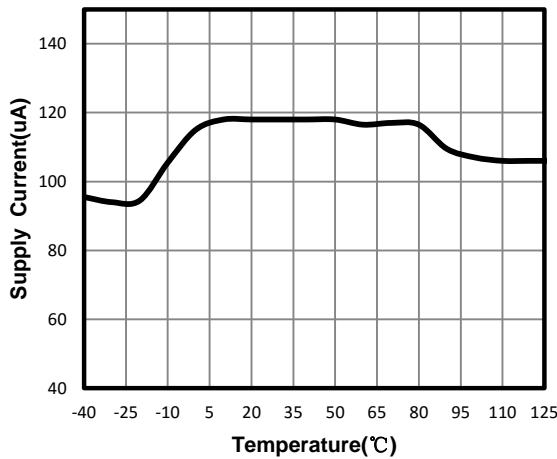

Short Circuit Current vs. Temperature

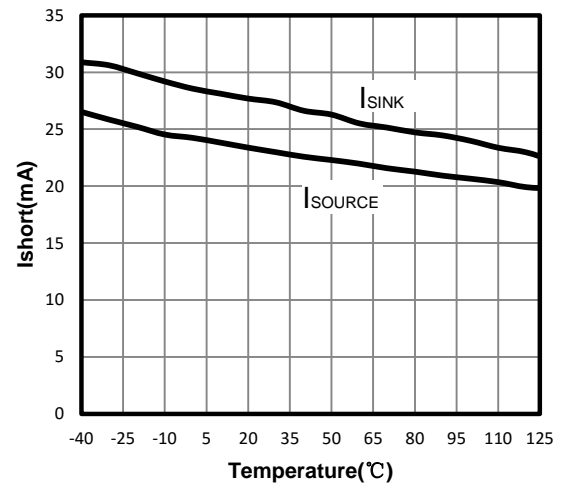

Power-Supply Rejection Ratio

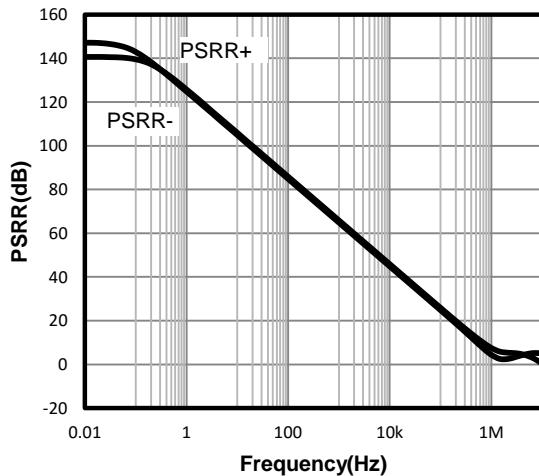

Quiescent Current vs. Supply Voltage

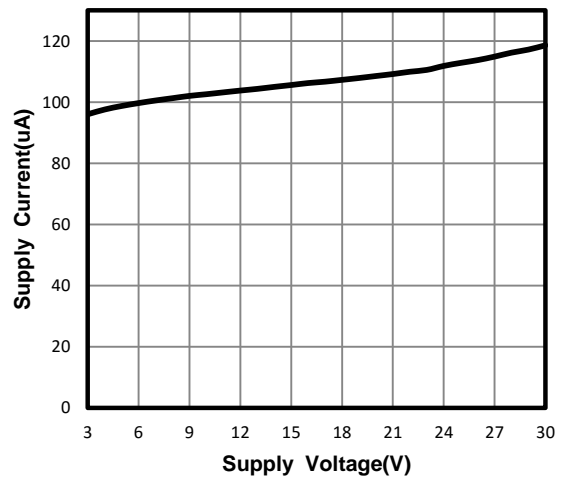

1.2MHz, Low-Power 36V Op Amps

Typical Performance Characteristics

$V_S = \pm 15V$, $V_{CM} = 0V$, $R_L = \text{Open}$, unless otherwise specified. (Continued)

Power-Supply Rejection Ratio vs. Temperature

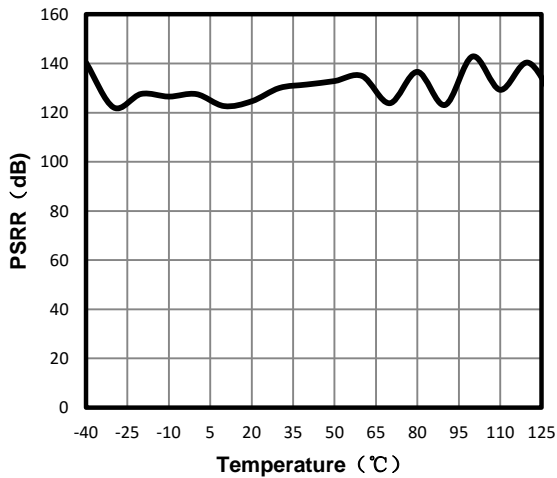

CMRR vs. Temperature

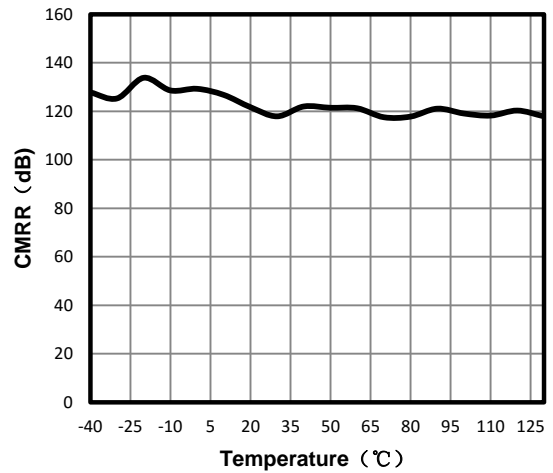

EMIRR IN+ vs. Frequency

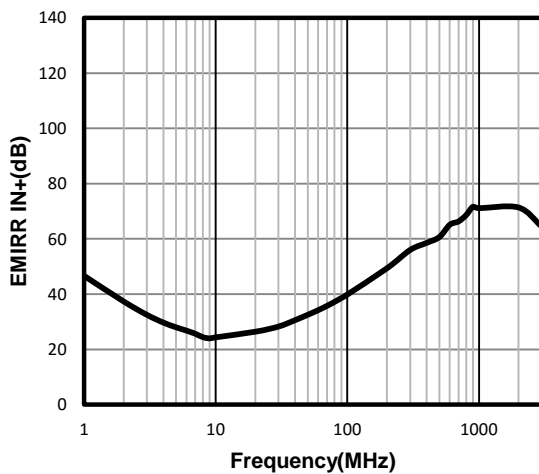

Small-Scale Step Response

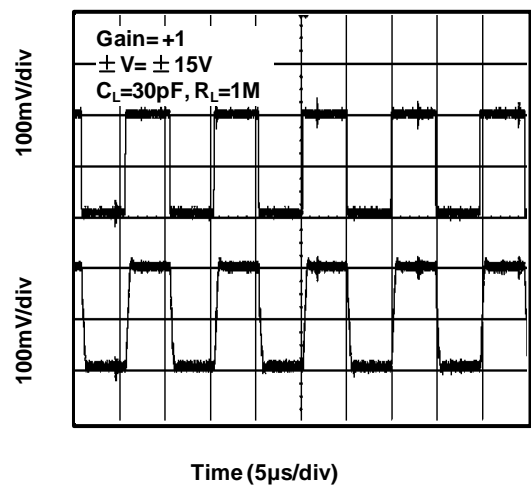

Negative Over-Voltage Recovery

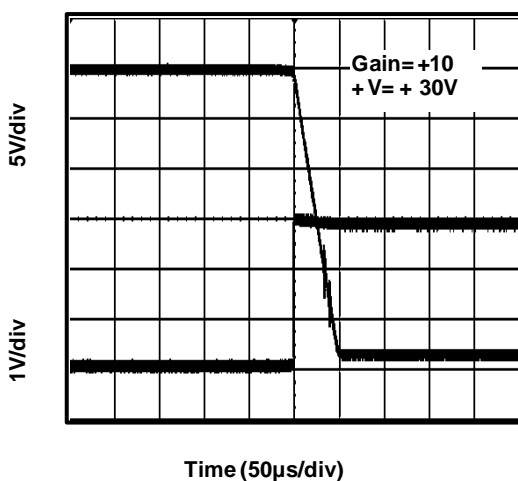

Positive Over-Voltage Recovery

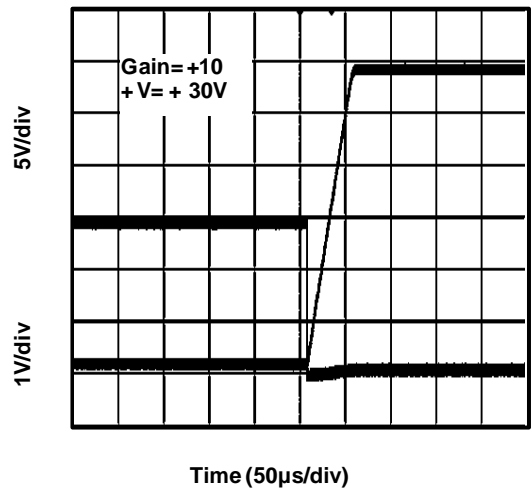

Typical Performance Characteristics

$V_S = \pm 15V$, $V_{CM} = 0V$, $R_L = \text{Open}$, unless otherwise specified. (Continued)

0.1 Hz TO 10 Hz Input Voltage Noise

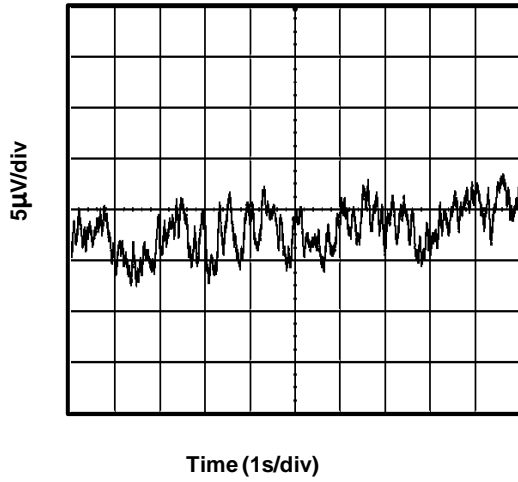

Offset Voltage vs Common-Mode Voltage

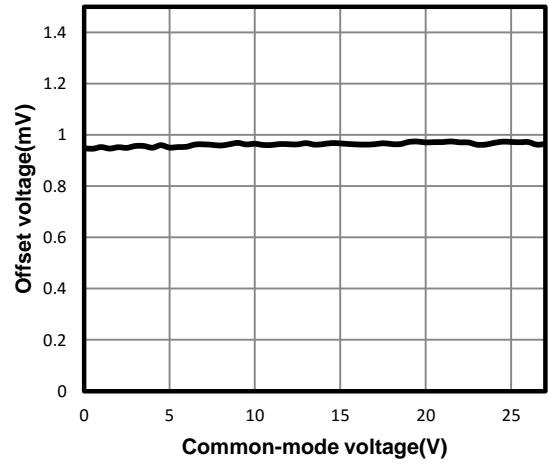

Large-Scale Step Response

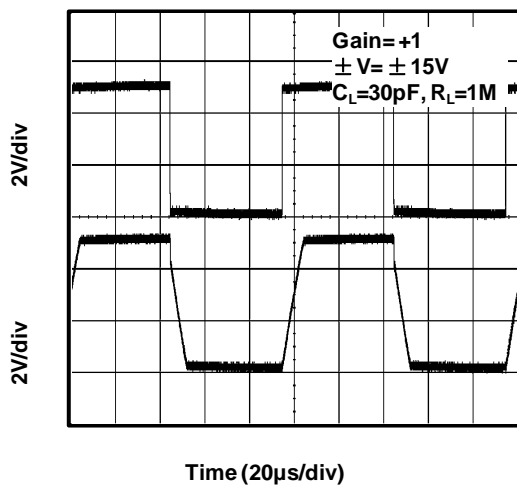

Positive Output Swing vs. Load Current

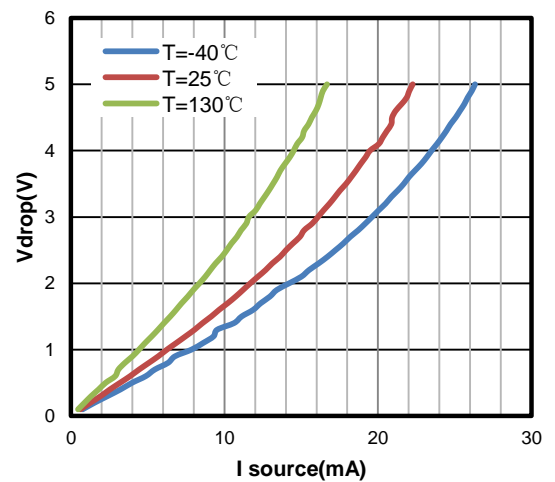

Negative Output Swing vs. Load Current

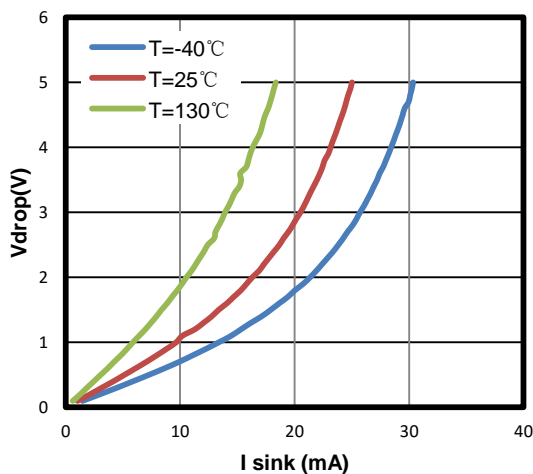

LM321 / LM358 / LM324

1.2MHz, Low-Power 36V Op Amps

Pin Functions

-IN: Inverting Input of the Amplifier.

+IN: Non-Inverting Input of Amplifier.

OUT: Amplifier Output. The voltage range extends to within mV of each supply rail.

V+ or +Vs: Positive Power Supply. Typically the voltage is from 3V to 36V. Split supplies are possible as long as the voltage between V+ and V- is between 3V and 36V. A bypass capacitor of 0.1 μ F as close to the part as

possible should be used between power supply pins or between supply pins and ground.

V- or -Vs: Negative Power Supply. It is normally tied to ground. It can also be tied to a voltage other than ground as long as the voltage between V+ and V- is from 3V to 36V. If it is not connected to ground, bypass it with a capacitor of 0.1 μ F as close to the part as possible.

Operation

The LM321/358/324 output signal range extends beyond the negative and positive power supplies. The input can even extend all the way to the negative supply. The Class-AB control buffer and output bias stage uses a proprietary compensation technique to take full advantage of the process technology to drive very high capacitive loads. This is evident from the transient over shoot measurement plots in the Typical Performance Characteristics.

Applications Information

High Supply Voltage and Low Power Consumption

The LM321/358/324 of operational amplifiers can operate with power supply voltages from 3V to 36V. Each amplifier draws only 100 μ A quiescent current. The low supply voltage capability and low supply current are ideal for portable applications demanding HIGH CAPACITIVE LOAD DRIVING CAPABILITY and WIDE BANDWIDTH. The LM321/358/324 is optimized for wide bandwidth low power applications. They have an industry leading high GBWP to power ratio and are unity gain stable for 10nf CAPACITIVE load. When the load capacitance increases, the increased capacitance at the output pushed the non-dominant pole to lower frequency in the open loop frequency response, lowering the phase and gain margin. Higher gain configurations tend to have better capacitive drive capability than lower gain configurations due to lower closed loop bandwidth and hence higher phase margin.

Low Input Referred Noise

The LM321/358/324 provides a low input referred noise density of 48nV/ $\sqrt{\text{Hz}}$ at 1kHz. The voltage noise will grow slowly with the frequency in wideband range, and the input voltage noise is typically 10 μ V_{P,P} at the frequency of 0.1Hz to 10Hz.

Low Input Offset Voltage

The LM321/358/324 has a low offset voltage tolerance of 3mV maximum which is essential for precision applications. The offset voltage is trimmed with a proprietary trim algorithm to ensure low offset voltage for precision signal processing requirement.

Low Input Bias Current

The LM321/358/324 is a CMOS OPA family and features very low input bias current in pA range. The low input bias current allows the amplifiers to be used in applications with high resistance sources. Care must be taken to minimize PCB Surface Leakage. See below section on "PCB Surface Leakage" for more details.

PCB Surface Leakage

1.2MHz, Low-Power 36V Op Amps

In applications where low input bias current is critical, Printed Circuit Board (PCB) surface leakage effects need to be considered. Surface leakage is caused by humidity, dust or other contamination on the board. Under low humidity conditions, a typical resistance between nearby traces is $10^{12}\Omega$. A 5V difference would cause 5pA of current to flow, which is greater than the LM321/358/324 OPA's input bias current at +27°C ($\pm 1\text{pA}$, typical). It is recommended to use multi-layer PCB layout and route the OPA's -IN and +IN signal under the PCB surface.

The effective way to reduce surface leakage is to use a guard ring around sensitive pins (or traces). The guard ring is biased at the same voltage as the sensitive pin. An example of this type of layout is shown in Figure 1 for Inverting Gain application.

1. For Non-Inverting Gain and Unity-Gain Buffer:

- a) Connect the non-inverting pin (V_{IN+}) to the input with a wire that does not touch the PCB surface.
- b) Connect the guard ring to the inverting input pin (V_{IN-}). This biases the guard ring to the Common Mode input voltage.

2. For Inverting Gain and Trans-impedance Gain Amplifiers (convert current to voltage, such as photo detectors):

- a) Connect the guard ring to the non-inverting input pin (V_{IN+}). This biases the guard ring to the same reference voltage as the op-amp (e.g., $V_S/2$ or ground).
- b) Connect the inverting pin (V_{IN-}) to the input with a wire that does not touch the PCB surface.

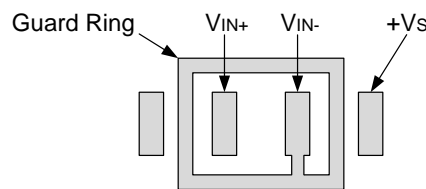

Figure 1

Ground Sensing and Rail to Rail Output

The LM321/358/324 has excellent output drive capability, delivering over 35mA of output drive current. The output stage is a rail-to-rail topology that is capable of swinging to within 5mV of either rail. Since the inputs can go 100mV beyond either rail, the op-amp can easily perform 'True Ground Sensing'.

The maximum output current is a function of total supply voltage. As the supply voltage to the amplifier increases, the output current capability also increases. Attention must be paid to keep the junction temperature of the IC below 150°C when the output is in continuous short-circuit. The output of the amplifier has reverse-biased ESD diodes connected to each supply. The output should not be forced more than 0.5V beyond either supply, otherwise current will flow through these diodes.

ESD

The LM321/358/324 has reverse-biased ESD protection diodes on all inputs and output. Input and out pins cannot be biased more than 200mV beyond either supply rail.

Feedback Components and Suppression of Ringing

Care should be taken to ensure that the pole formed by the feedback resistors and the parasitic capacitance at the inverting input does not degrade stability. For example, in a gain of +2 configuration with gain and feedback resistors of 10k, a poorly designed circuit board layout with parasitic capacitance of 5pF (part +PC board) at the amplifier's inverting input will cause the amplifier to ring due to a pole formed at 1.2MHz. An additional capacitor of 5pF across the feedback resistor as shown in Figure 2 will eliminate any ringing.

Careful layout is extremely important because low power signal conditioning applications demand high-impedance circuits. The layout should also minimize stray capacitance at the OPA's inputs. However some stray capacitance may be unavoidable and it may be necessary to add a 2pF to 10pF capacitor across the feedback resistor. Select the smallest capacitor value that ensures stability.

1.2MHz, Low-Power 36V Op Amps

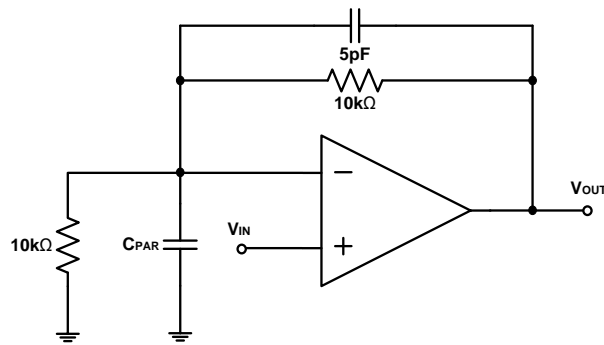

Figure 2

Driving Large Capacitive Load

The LM321/358/324 of OPA is designed to drive large capacitive loads. Refer to Typical Performance Characteristics for “Phase Margin vs. Load Capacitance”. As always, larger load capacitance decreases overall phase margin in a feedback system where internal frequency compensation is utilized. As the load capacitance increases, the feedback loop’s phase margin decreases, and the closed-loop bandwidth is reduced. This produces gain peaking in the frequency response, with overshoot and ringing in output step response. The unity-gain buffer ($G = +1V/V$) is the most sensitive to large capacitive loads.

When driving large capacitive loads with the LM321/358/324 (e.g., > 200 pF when $G = +1V/V$), a small series resistor at the output (R_{ISO} in Figure 3) improves the feedback loop’s phase margin and stability by making the output load resistive at higher frequencies.

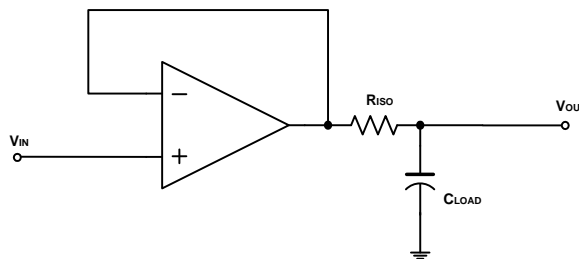

Figure 3

Power Supply Layout and Bypass

The LM321/358/324 OPA’s power supply pin should have a local bypass capacitor (i.e., $0.01\mu F$ to $0.1\mu F$) within 2mm for good high frequency performance. It can also use a bulk capacitor (i.e., $1\mu F$ or larger) within 100mm to provide large, slow currents. This bulk capacitor can be shared with other analog parts.

Ground layout improves performance by decreasing the amount of stray capacitance and noise at the OPA’s inputs and outputs. To decrease stray capacitance, minimize PCB board lengths and resistor leads, and place external components as close to the op amps’ pins as possible.

Proper Board Layout

To ensure optimum performance at the PCB level, care must be taken in the design of the board layout. To avoid leakage currents, the surface of the board should be kept clean and free of moisture. Coating the surface creates a barrier to moisture accumulation and helps reduce parasitic resistance on the board.

Keeping supply traces short and properly bypassing the power supplies minimizes power supply disturbances due to output current variation, such as when driving an ac signal into a heavy load. Bypass capacitors should be connected as closely as possible to the device supply pins. Stray capacitances are a concern at the outputs and the inputs of the amplifier. It is recommended that signal traces be kept at least 5mm from supply lines to minimize coupling.

A variation in temperature across the PCB can cause a mismatch in the Seebeck voltages at solder joints and other points where dissimilar metals are in contact, resulting in thermal voltage errors. To minimize these thermocouple effects, orient resistors so heat sources warm both ends equally. Input signal paths should contain matching numbers

1.2MHz, Low-Power 36V Op Amps

and types of components, where possible to match the number and type of thermocouple junctions. For example, dummy components such as zero value resistors can be used to match real resistors in the opposite input path. Matching components should be located in close proximity and should be oriented in the same manner. Ensure leads are of equal length so that thermal conduction is in equilibrium. Keep heat sources on the PCB as far away from amplifier input circuitry as is practical.

The use of a ground plane is highly recommended. A ground plane reduces EMI noise and also helps to maintain a constant temperature across the circuit board.

Instrumentation Amplifier

The LM321/358/324 OPA is well suited for conditioning sensor signals in battery-powered applications. Figure 4 shows a two op-amp instrumentation amplifier, using the LM321/358/324 OPA.

The circuit works well for applications requiring rejection of Common Mode noise at higher gains. The reference voltage (V_{REF}) is supplied by a low-impedance source. In single voltage supply applications, V_{REF} is typically $V_S/2$.

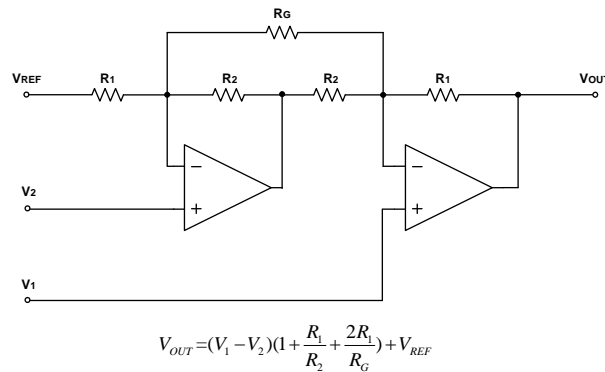

Figure 4

Two-Pole Micro-power Sallen-Key Low-Pass Filter

Figure 5 shows a micro-power two-pole Sallen-Key Low-Pass Filter with 400Hz cut-off frequency. For best results, the filter's cut-off frequency should be 8 to 10 times lower than the OPA's crossover frequency. Additional OPA's phase margin shift can be avoided if the OPA's bandwidth-to-signal ratio is greater than 8. The design equations for the 2-pole Sallen-Key low-pass filter are given below with component values selected to set a 400Hz low-pass filter cutoff frequency:

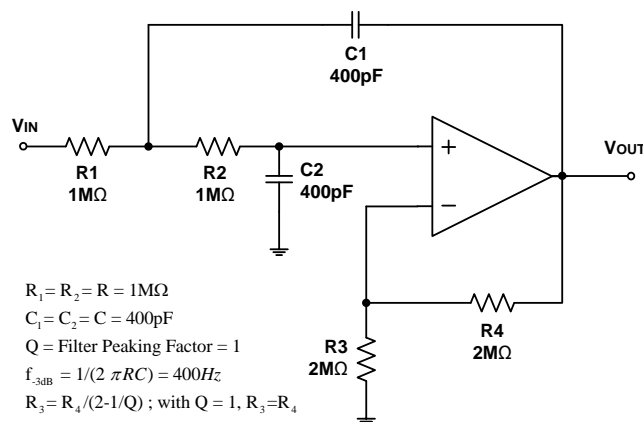

Figure 5

LM321 / LM358 / LM324

1.2MHz, Low-Power 36V Op Amps

Package Outline Dimensions

SC70-5 / SOT-353

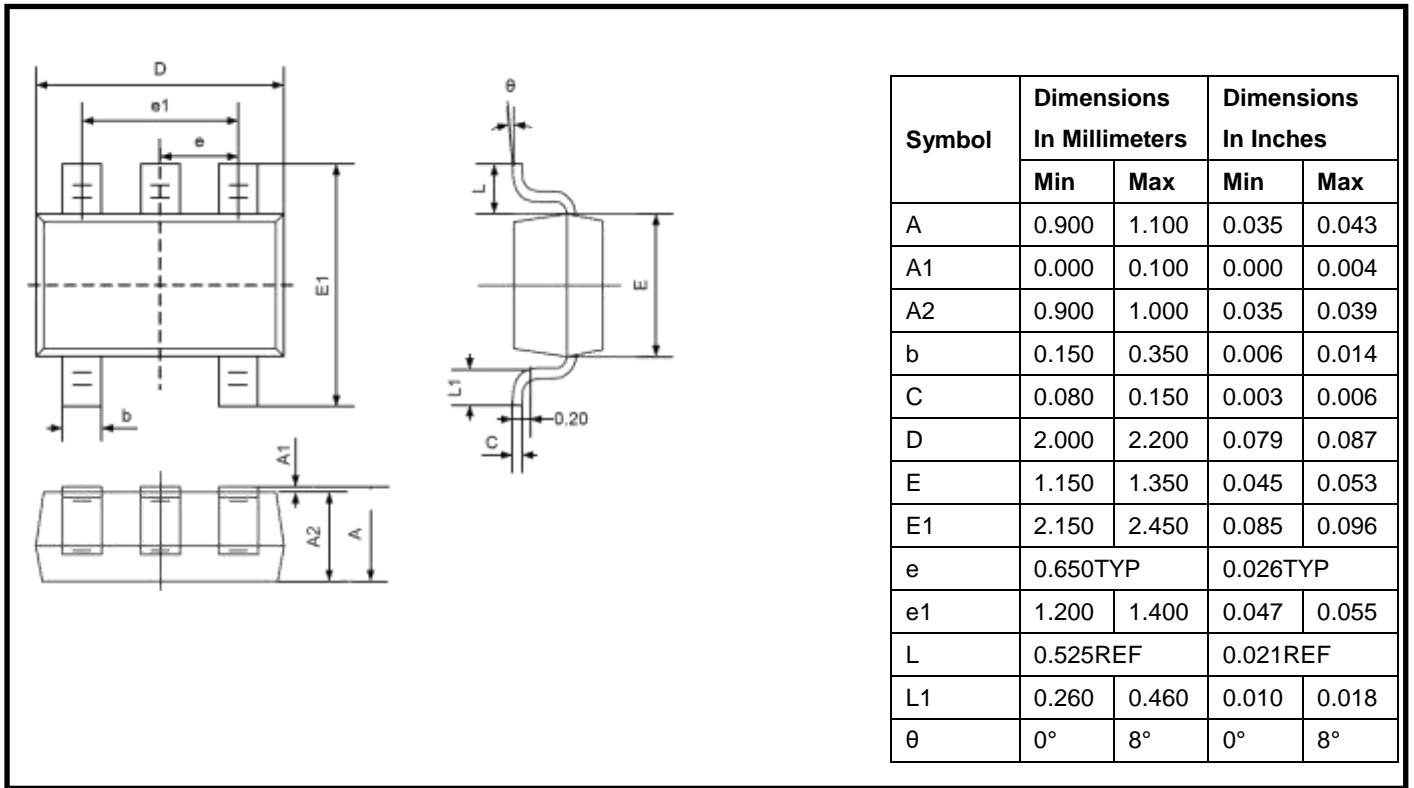

SOT23-5

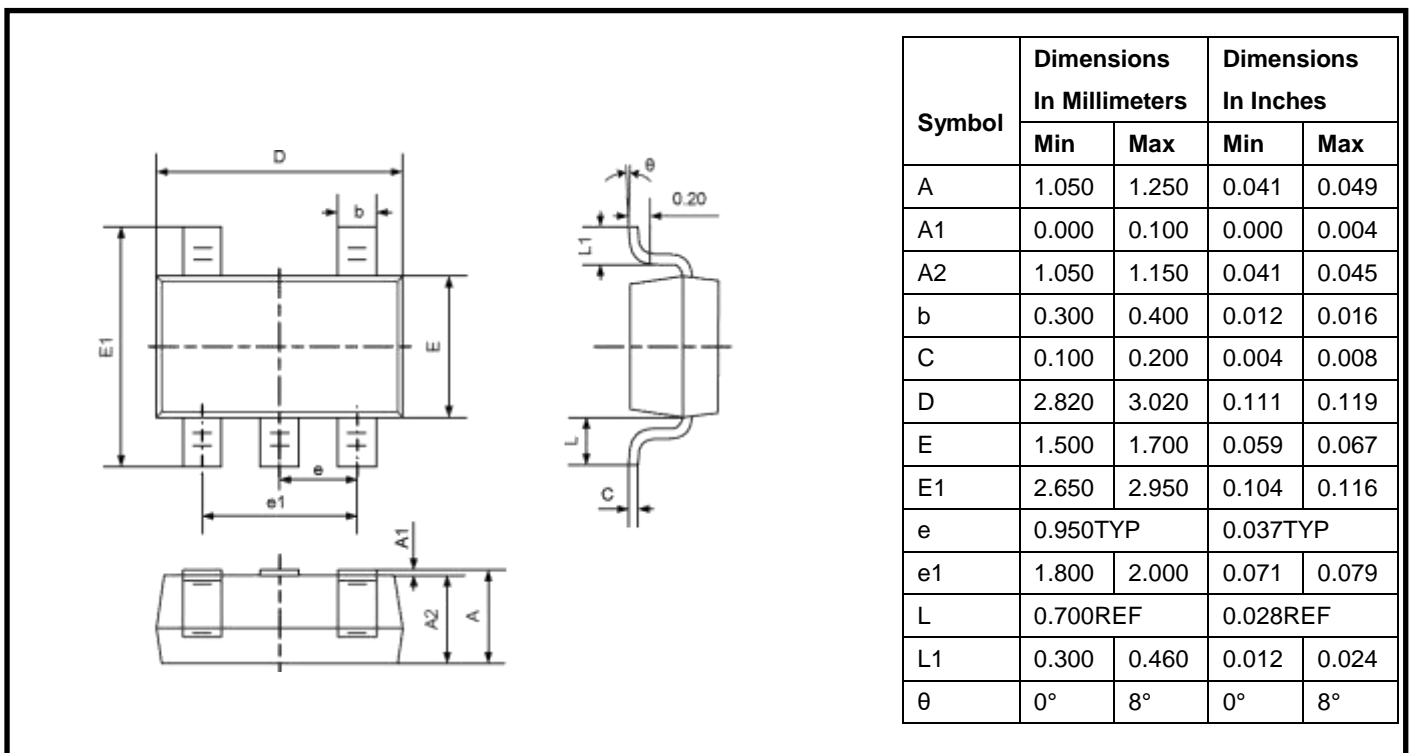

Package Outline Dimensions

SOP-8

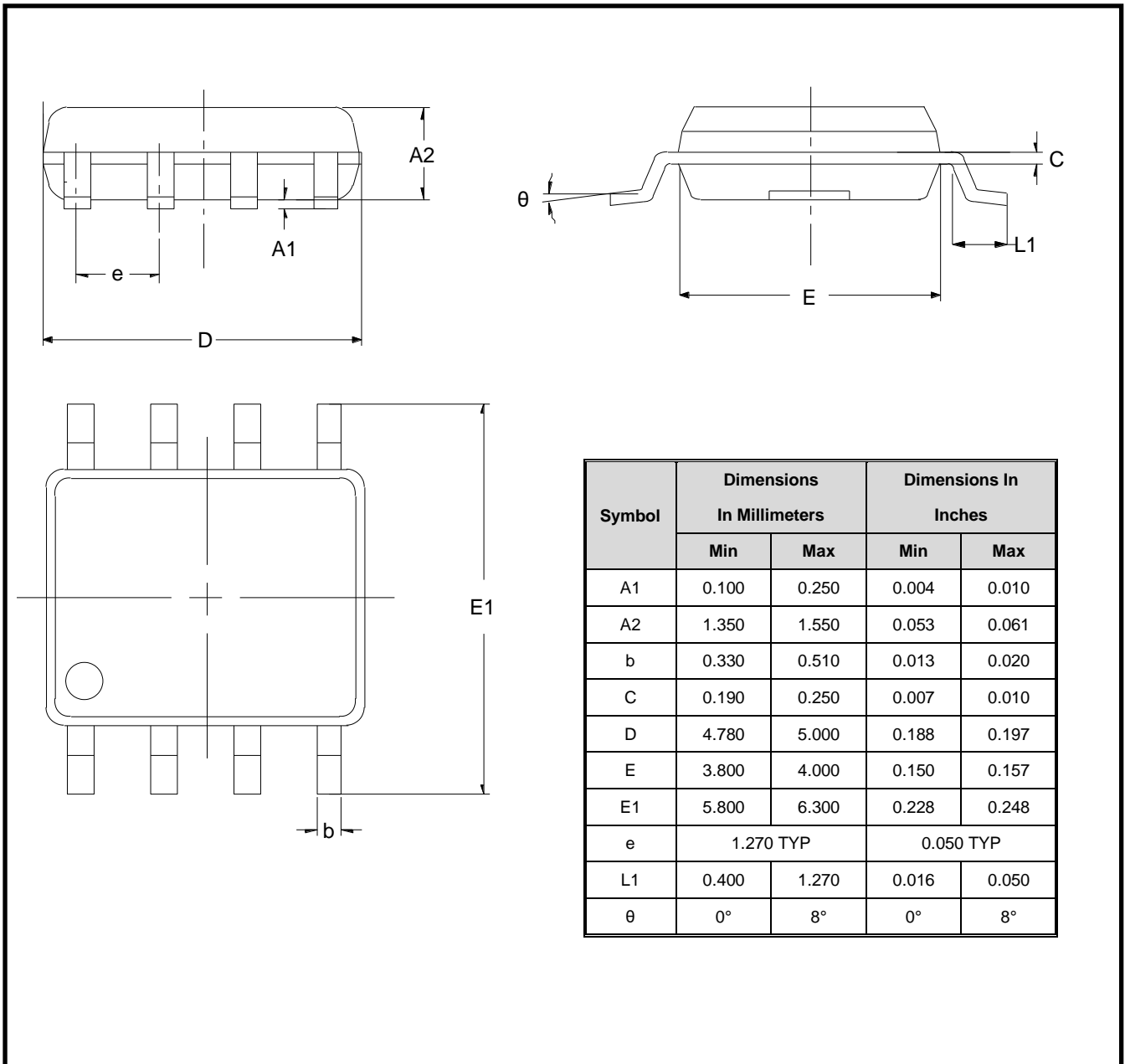

LM321 / LM358 / LM324

1.2MHz, Low-Power 36V Op Amps

Package Outline Dimensions

MSOP-8

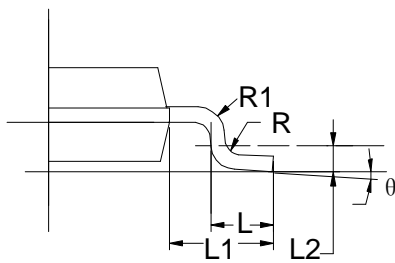
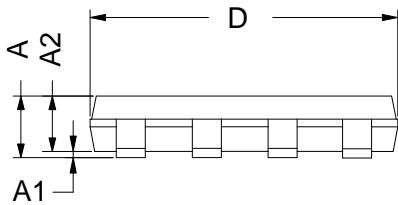
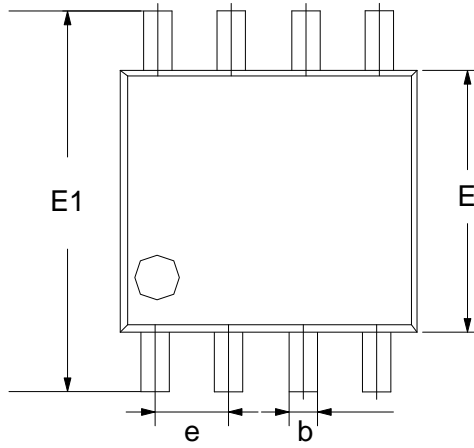

| Symbol | Dimensions In Millimeters | | Dimensions In Inches | |
|--------|------------------------------|-------|-------------------------|-------|
| | Min | Max | Min | Max |
| A | 0.800 | 1.200 | 0.031 | 0.047 |
| A1 | 0.000 | 0.200 | 0.000 | 0.008 |
| A2 | 0.760 | 0.970 | 0.030 | 0.038 |
| b | 0.30 TYP | | 0.012 TYP | |
| C | 0.15 TYP | | 0.006 TYP | |
| D | 2.900 | 3.100 | 0.114 | 0.122 |
| e | 0.65 TYP | | 0.026 | |
| E | 2.900 | 3.100 | 0.114 | 0.122 |
| E1 | 4.700 | 5.100 | 0.185 | 0.201 |
| L1 | 0.410 | 0.650 | 0.016 | 0.026 |
| θ | 0° | 6° | 0° | 6° |

Package Outline Dimensions

TSSOP-14

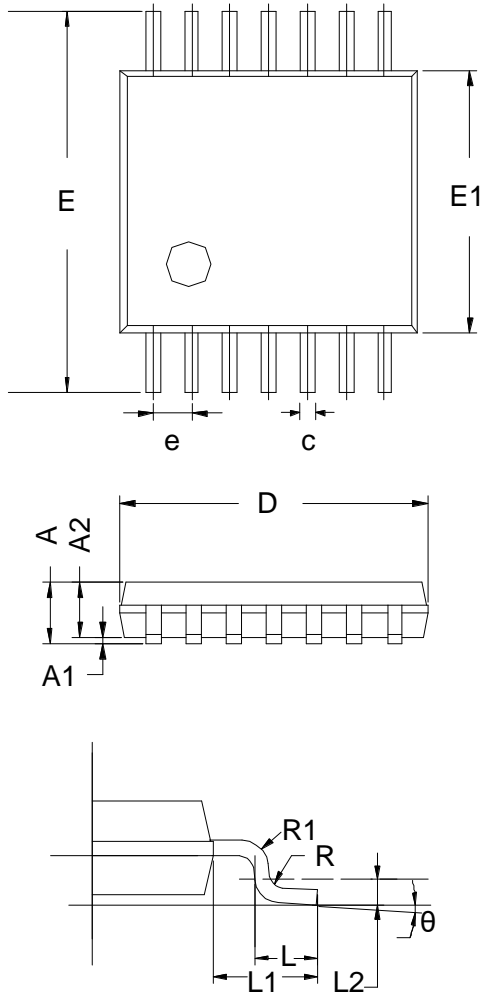

| Symbol | Dimensions In Millimeters | | |
|--------|------------------------------|------|------|
| | MIN | TYP | MAX |
| A | - | - | 1.20 |
| A1 | 0.05 | - | 0.15 |
| A2 | 0.90 | 1.00 | 1.05 |
| b | 0.20 | - | 0.28 |
| c | 0.10 | - | 0.19 |
| D | 4.86 | 4.96 | 5.06 |
| E | 6.20 | 6.40 | 6.60 |
| E1 | 4.30 | 4.40 | 4.50 |
| e | 0.65 BSC | | |
| L | 0.45 | 0.60 | 0.75 |
| L1 | 1.00 REF | | |
| L2 | 0.25 BSC | | |
| R | 0.09 | - | - |
| θ | 0° | - | 8° |

LM321 / LM358 / LM324

1.2MHz, Low-Power 36V Op Amps Package Outline Dimensions

SOP-14

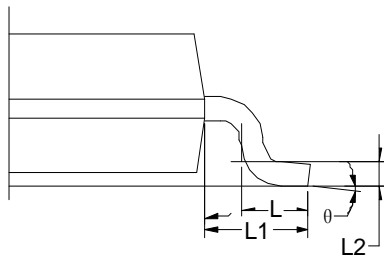
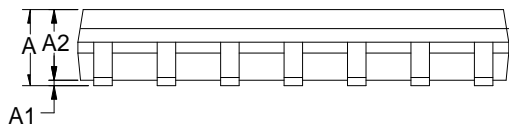
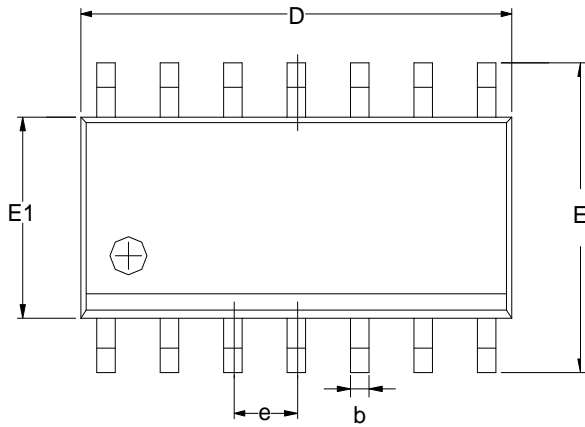

| Symbol | Dimensions In Millimeters | | |
|--------|------------------------------|------|------|
| | MIN | TYP | MAX |
| A | 1.35 | 1.60 | 1.75 |
| A1 | 0.10 | 0.15 | 0.25 |
| A2 | 1.25 | 1.45 | 1.65 |
| b | 0.36 | | 0.49 |
| D | 8.53 | 8.63 | 8.73 |
| E | 5.80 | 6.00 | 6.20 |
| E1 | 3.80 | 3.90 | 4.00 |
| e | 1.27 BSC | | |
| L | 0.45 | 0.60 | 0.80 |
| L1 | 1.04 REF | | |
| L2 | 0.25 BSC | | |
| θ | 0° | | 8° |