



150-mW STEREO AUDIO POWER AMPLIFIER

 Check for Samples: [TPA6110A2](#)

FEATURES

- 150 mW Stereo Output
- PC Power Supply Compatible
 - Fully Specified for 3.3 V and 5 V Operation
 - Operation to 2.5 V
- Pop Reduction Circuitry
- Internal Mid-Rail Generation
- Thermal and Short-Circuit Protection
- Surface-Mount Packaging
 - PowerPAD™ MSOP
- Pin Compatible With LM4881

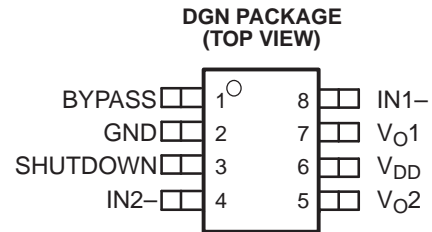

DESCRIPTION

The TPA6110A2 is a stereo audio power amplifier packaged in an 8-pin PowerPAD™ MSOP package capable of delivering 150 mW of continuous RMS power per channel into 16-Ω loads. Amplifier gain is externally configured by means of two resistors per input channel and does not require external compensation for settings of 1 to 10.

THD+N when driving a 16-Ω load from 5 V is 0.03% at 1 kHz, and less than 1% across the audio band of 20 Hz to 20 kHz. For 32-Ω loads, the THD+N is reduced to less than 0.02% at 1 kHz, and is less than 1% across the audio band of 20 Hz to 20 kHz. For 10-kΩ loads, the THD+N performance is 0.005% at 1 kHz, and less than 0.5% across the audio band of 20 Hz to 20 kHz.

TYPICAL APPLICATION CIRCUIT

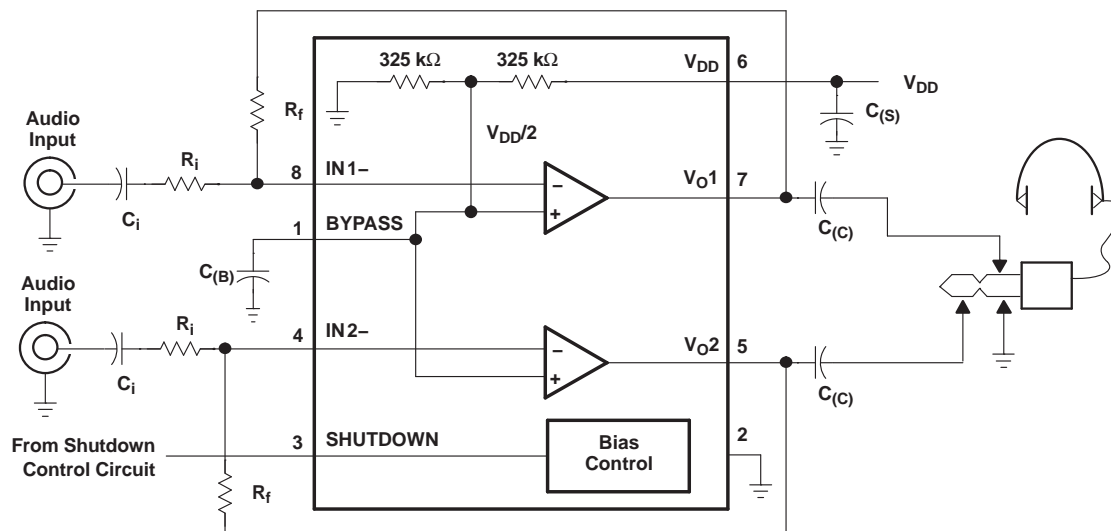

Please be aware that an important notice concerning availability, standard warranty, and use in critical applications of Texas Instruments semiconductor products and disclaimers thereto appears at the end of this data sheet.

PowerPAD is a trademark of Texas Instruments.



These devices have limited built-in ESD protection. The leads should be shorted together or the device placed in conductive foam during storage or handling to prevent electrostatic damage to the MOS gates.

AVAILABLE OPTIONS

T _A	PACKAGED DEVICE	MSOP SYMBOLIZATION
	MSOP ⁽¹⁾	
-40°C to 85°C	TPA6110A2DGN	TI AIZ

(1) The DGN package is available in left-ended tape and reel only (e.g., TPA6110A2DGNR).

PinFunctions

NAME	PIN NO.	I/O	DESCRIPTION
BYPASS	1	I	Tap to voltage divider for internal mid-supply bias supply. Connect to a 0.1 μF to 1 μF low ESR capacitor for best performance.
GND	2	I	GND is the ground connection.
IN1–	8	I	IN1– is the inverting input for channel 1.
IN2–	4	I	IN2– is the inverting input for channel 2.
SHUTDOWN	3	I	Puts the device in a low quiescent current mode when held high.
V _{DD}	6	I	V _{DD} is the supply voltage terminal.
V _{O1}	7	O	V _{O1} is the audio output for channel 1.
V _{O2}	5	O	V _{O2} is the audio output for channel 2.

ABSOLUTE MAXIMUM RATINGS⁽¹⁾

over operating free-air temperature range (unless otherwise noted)

	UNIT
V _{DD} Supply voltage	6 V
V _I Input voltage	–0.3 V to V _{DD} + 0.3 V
Continuous total power dissipation	Internally limited
T _J Operating junction temperature range	–40°C to 150°C
T _{stg} Storage temperature range	–65°C to 150°C

(1) Stresses beyond those listed under "absolute maximum ratings" may cause permanent damage to the device. These are stress ratings only, and functional operation of the device at these or any other conditions beyond those indicated under "recommended operating conditions" is not implied. Exposure to absolute-maximum-rated conditions for extended periods may affect device reliability.

DISSIPATION RATING TABLE

PACKAGE	T _A ≤ 25°C POWER RATING	DERATING FACTOR ABOVE T _A = 25°C	T _A = 70°C POWER RATING	T _A = 85°C POWER RATING
DGN	2.14 W ⁽¹⁾	17.1 mW/°C	1.37 W	1.11 W

(1) See the Texas Instruments document, *PowerPAD Thermally Enhanced Package Application Report (SLMA002)*, for more information on the PowerPAD™ package. The thermal data was measured on a PCB layout based on the information in the section entitled *Texas Instruments Recommended Board for PowerPAD* on page 33 of the before mentioned document.

RECOMMENDED OPERATING CONDITIONS

	MIN	MAX	UNIT
V _{DD} Supply voltage	2.5	5.5	V
T _A Operating free-air temperature	–40	85	°C
V _{IH} High-level input voltage (SHUTDOWN)	60% x V _{DD}		V
V _{IL} Low-level input voltage (SHUTDOWN)	25% x V _{DD}		V

DC ELECTRICAL CHARACTERISTICS

 at $T_A = 25^\circ\text{C}$, $V_{DD} = 2.5\text{ V}$ (unless otherwise noted)

PARAMETER		TEST CONDITIONS	MIN	TYP	MAX	UNIT
V_{OO}	Output offset voltage	$A_V = 2\text{ V/V}$			15	mV
PSRR	Power supply rejection ratio	$V_{DD} = 3.2\text{ V to } 3.4\text{ V}$		83		dB
I_{DD}	Supply current	SHUTDOWN = 0 V		1.5	3	mA
$I_{DD(SD)}$	Supply current in shutdown mode	SHUTDOWN = V_{DD}		1	10	μA

AC OPERATING CHARACTERISTICS

 $V_{DD} = 3.3\text{ V}$, $T_A = 25^\circ\text{C}$, $R_L = 16\ \Omega$

PARAMETER		TEST CONDITIONS	MIN	TYP	MAX	UNIT
P_O	Output power (each channel)	THD $\leq 0.1\%$, $f = 1\text{ kHz}$		60		mW
THD+N	Total harmonic distortion + noise	$P_O = 40\text{ mW}$, 20 - 20 kHz		0.4%		
B_{OM}	Maximum output power BW	$G = 10$, THD < 5%		> 20		kHz
	Phase margin	Open loop		96°		
	Supply ripple rejection ratio	$f = 1\text{ kHz}$		71		dB
	Channel/channel output separation	$f = 1\text{ kHz}$, $P_O = 40\text{ mW}$		89		dB
SNR	Signal-to-noise ratio	$P_O = 50\text{ mW}$, $A_V = 1$		100		dB
V_n	Noise output voltage	$A_V = 1$		11		$\mu\text{V(rms)}$

DC ELECTRICAL CHARACTERISTICS

 at $T_A = 25^\circ\text{C}$, $V_{DD} = 5.5\text{ V}$ (unless otherwise noted)

PARAMETER		TEST CONDITIONS	MIN	TYP	MAX	UNIT
V_{OO}	Output offset voltage	$A_V = 2\text{ V/V}$			15	mV
PSRR	Power supply rejection ratio	$V_{DD} = 4.9\text{ V to } 5.1\text{ V}$		76		dB
I_{DD}	Supply current	SHUTDOWN = 0 V		1.5	3	mA
$I_{DD(SD)}$	Supply current in shutdown mode	SHUTDOWN = V_{DD}		1	10	μA
$ I_{IH} $	High-level input current (SHUTDOWN)	$V_{DD} = 5.5\text{ V}$, $V_I = V_{DD}$			1	μA
$ I_{IL} $	Low-level input current (SHUTDOWN)	$V_{DD} = 5.5\text{ V}$, $V_I = 0\text{ V}$			1	μA
Z_i	Input impedance			>1		M Ω

AC OPERATING CHARACTERISTICS

 $V_{DD} = 5\text{ V}$, $T_A = 25^\circ\text{C}$, $R_L = 16\ \Omega$

PARAMETER		TEST CONDITIONS	MIN	TYP	MAX	UNIT
P_O	Output power (each channel)	THD $\leq 0.1\%$, $f = 1\text{ kHz}$		150		mW
THD+N	Total harmonic distortion + noise	$P_O = 100\text{ mW}$, 20 - 20 kHz		0.6%		
B_{OM}	Maximum output power BW	$G = 10$, THD < 5%		> 20		kHz
	Phase margin	Open loop		96°		
	Supply ripple rejection ratio	$f = 1\text{ kHz}$		61		dB
	Channel/Channel output separation	$f = 1\text{ kHz}$, $P_O = 100\text{ mW}$		90		dB
SNR	Signal-to-noise ratio	$P_O = 100\text{ mW}$, $A_V = 1$		100		dB
V_n	Noise output voltage	$A_V = 1$		11.7		$\mu\text{V(rms)}$

AC OPERATING CHARACTERISTICS

 $V_{DD} = 3.3\text{ V}$, $T_A = 25^\circ\text{C}$, $R_L = 32\ \Omega$

PARAMETER		TEST CONDITIONS	MIN	TYP	MAX	UNIT
P_O	Output power (each channel)	THD $\leq 0.1\%$, $f = 1\text{ kHz}$		40		mW
THD+N	Total harmonic distortion + noise	$P_O = 30\text{ mW}$, 20 - 20 kHz		0.4%		
B_{OM}	Maximum output power BW	$A_V = 10$, THD < 2%		> 20		kHz

AC OPERATING CHARACTERISTICS (continued) $V_{DD} = 3.3\text{ V}$, $T_A = 25^\circ\text{C}$, $R_L = 32\ \Omega$

PARAMETER	TEST CONDITIONS	MIN	TYP	MAX	UNIT
Phase margin	Open loop		96°		
Supply ripple rejection ratio	$f = 1\text{ kHz}$		71		dB
Channel/channel output separation	$f = 1\text{ kHz}$		95		dB
SNR	Signal-to-noise ratio		100		dB
V_n	Noise output voltage		11		$\mu\text{V(rms)}$

AC OPERATING CHARACTERISTICS $V_{DD} = 5\text{ V}$, $T_A = 25^\circ\text{C}$, $R_L = 32\ \Omega$

PARAMETER	TEST CONDITIONS	MIN	TYP	MAX	UNIT
P_O	Output power (each channel)		90		mW
THD+N	Total harmonic distortion + noise		0.4%		
B_{OM}	Maximum output power BW		> 20		kHz
Phase margin	Open loop		97°		
Supply ripple rejection ratio	$f = 1\text{ kHz}$		61		dB
Channel/channel output separation	$f = 1\text{ kHz}$		98		dB
SNR	Signal-to-noise ratio		100		dB
V_n	Noise output voltage		11.7		$\mu\text{V(rms)}$

TYPICAL CHARACTERISTICS

Table of Graphs

		FIGURE
THD+N	Total harmonic distortion plus noise	1, 3, 5, 6, 7, 9, 11, 13
	Supply ripple rejection ratio	15, 16
V_n	Output noise voltage	17, 18
	Crosstalk	19–24
	Shutdown attenuation	25, 26
	Open-loop gain and phase margin	27, 28
	Output power	29, 30
I_{DD}	Supply current	31
SNR	Signal-to-noise ratio	32
	Power dissipation/amplifier	33, 34

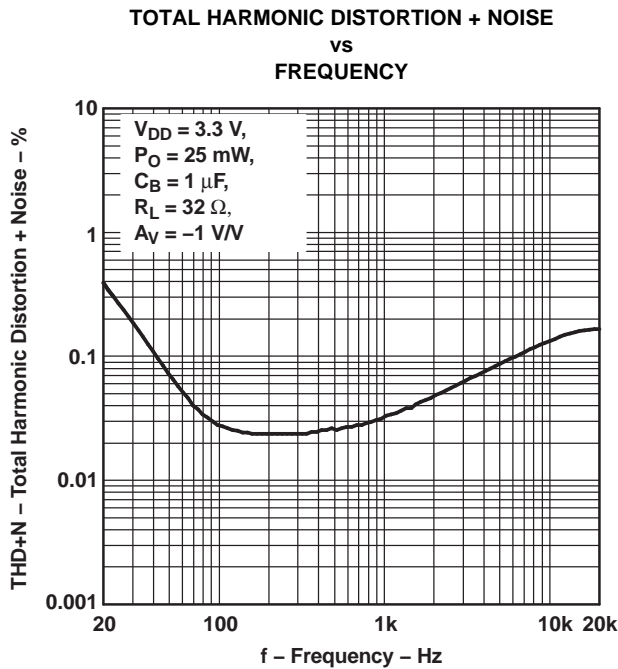

Figure 1.

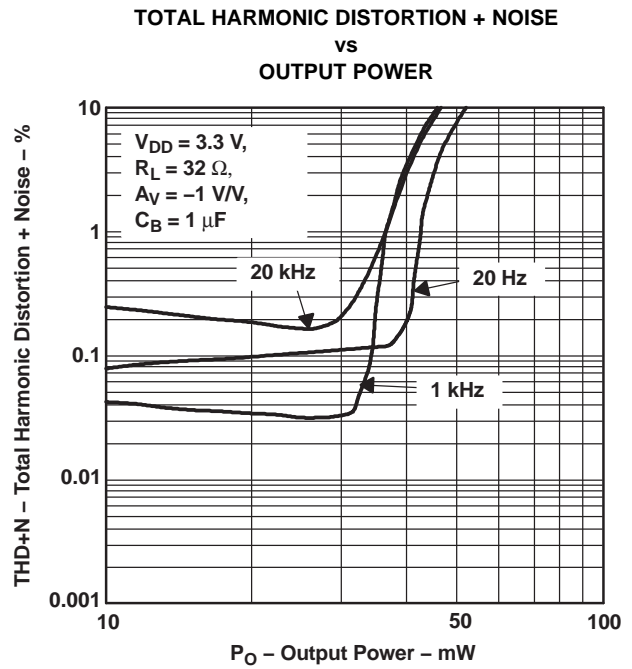

Figure 2.

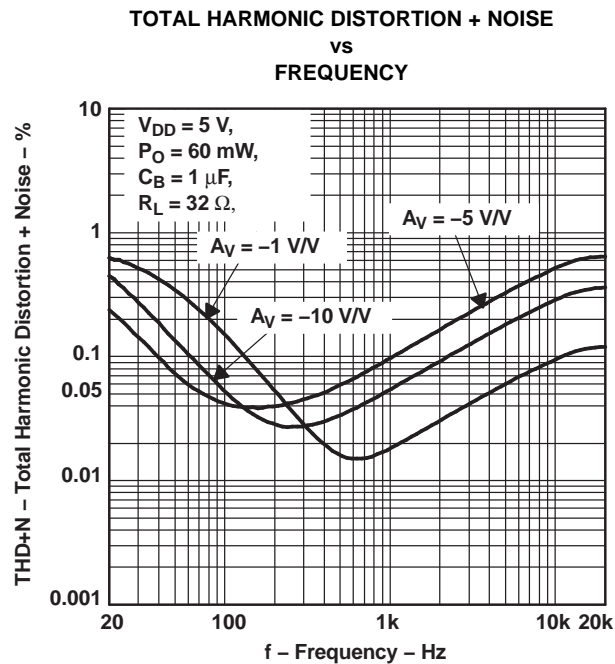

Figure 3.

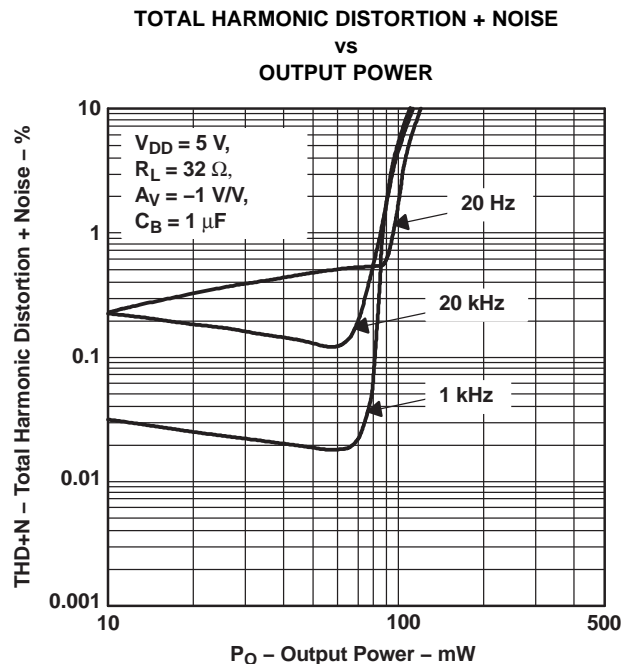

Figure 4.

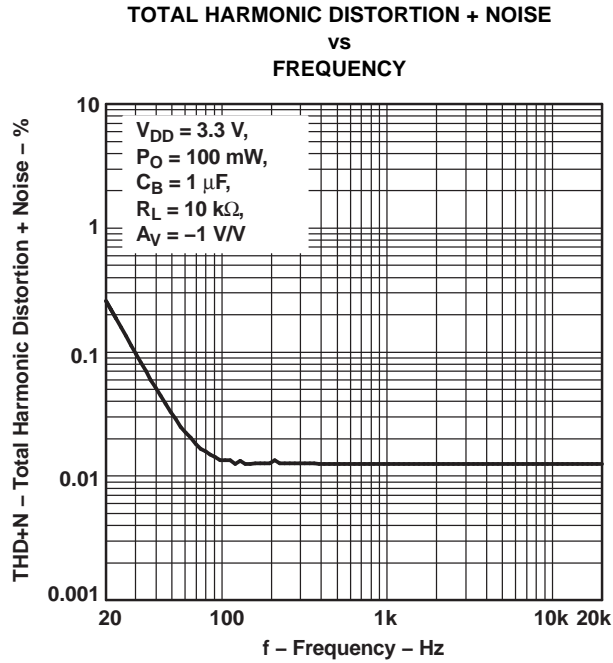

Figure 5.

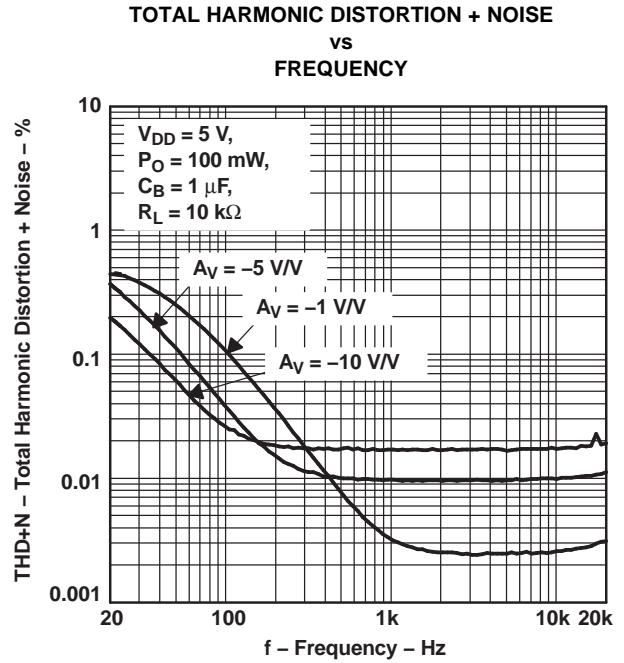

Figure 6.

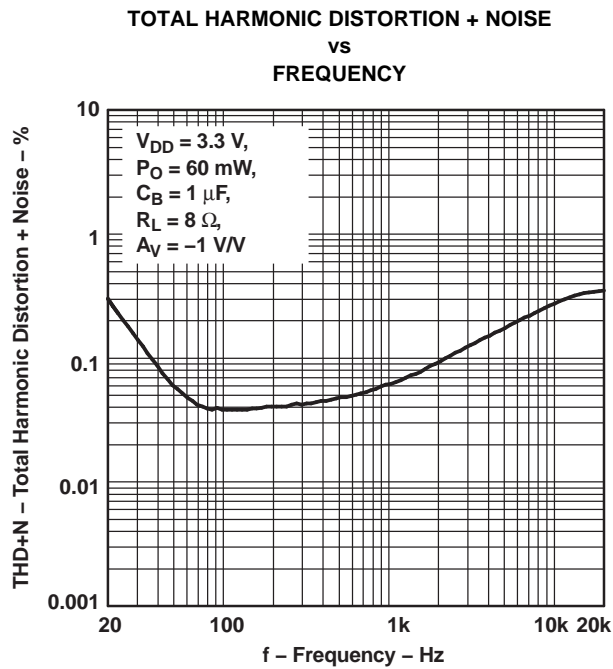

Figure 7.

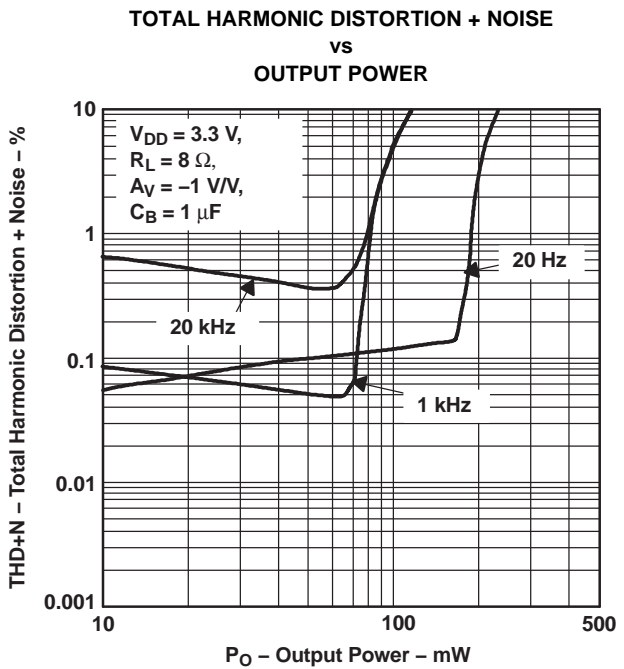

Figure 8.

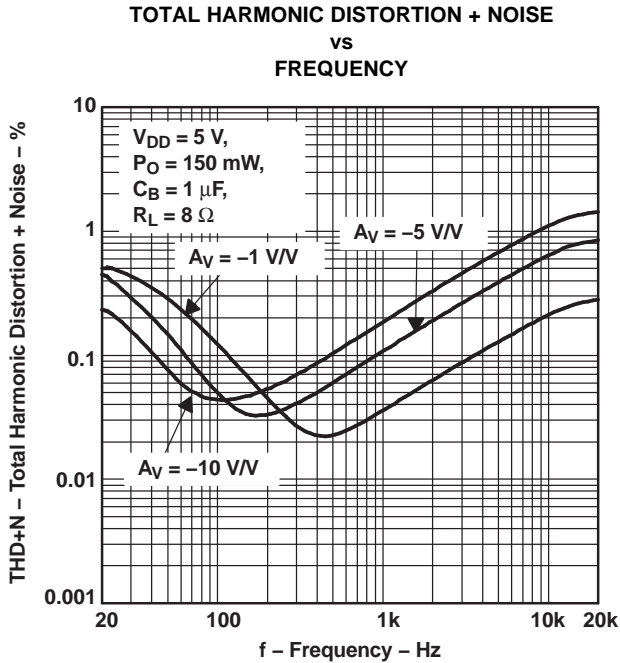

Figure 9.

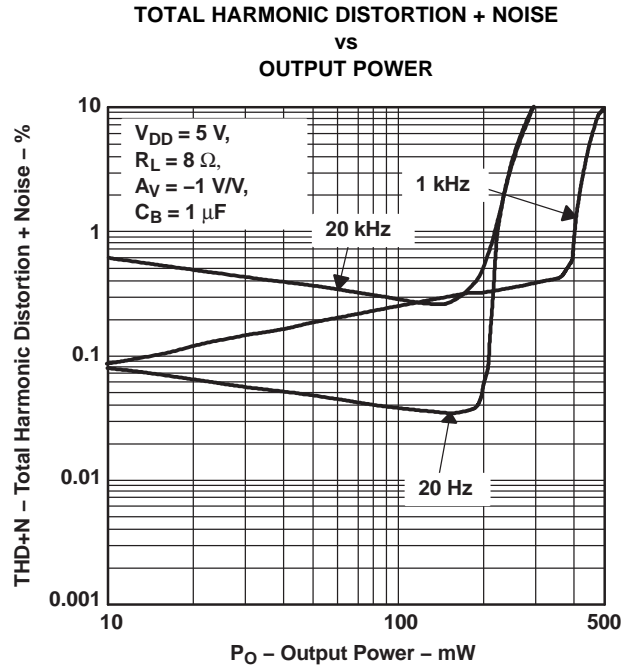

Figure 10.

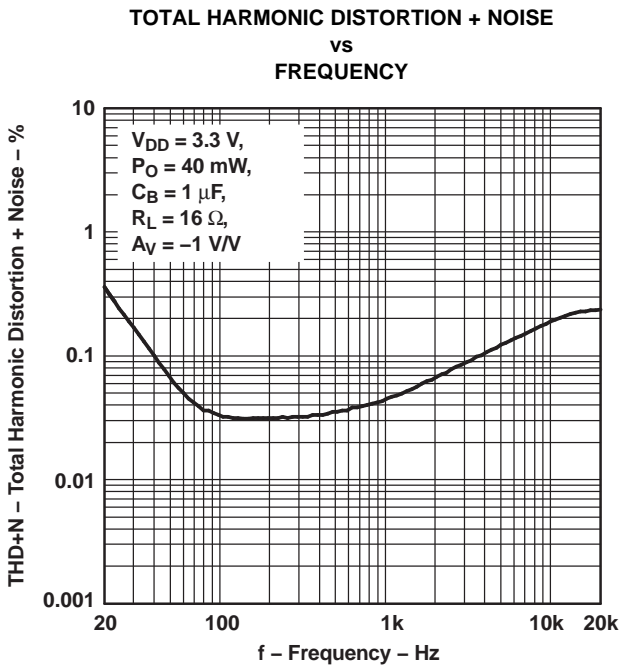

Figure 11.

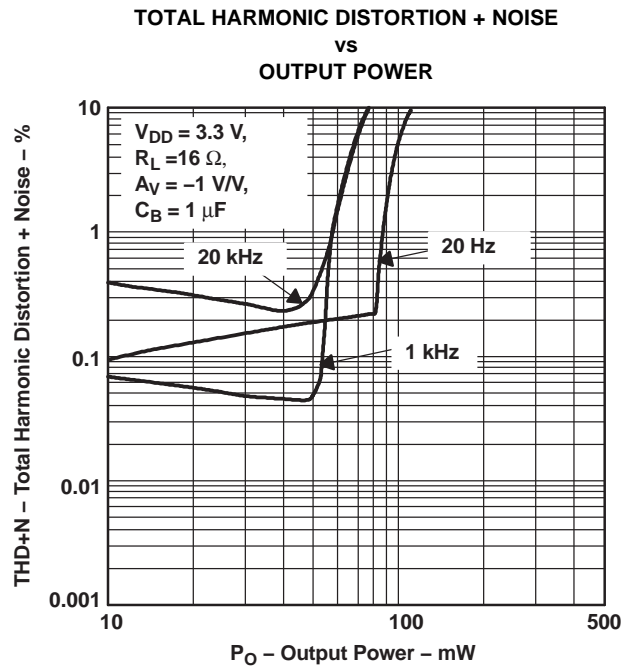

Figure 12.

**TOTAL HARMONIC DISTORTION + NOISE
vs
FREQUENCY**

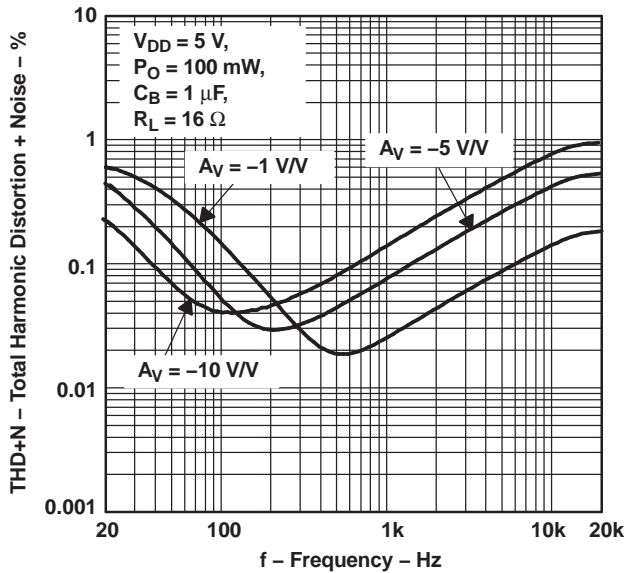

Figure 13.

**TOTAL HARMONIC DISTORTION + NOISE
vs
OUTPUT POWER**

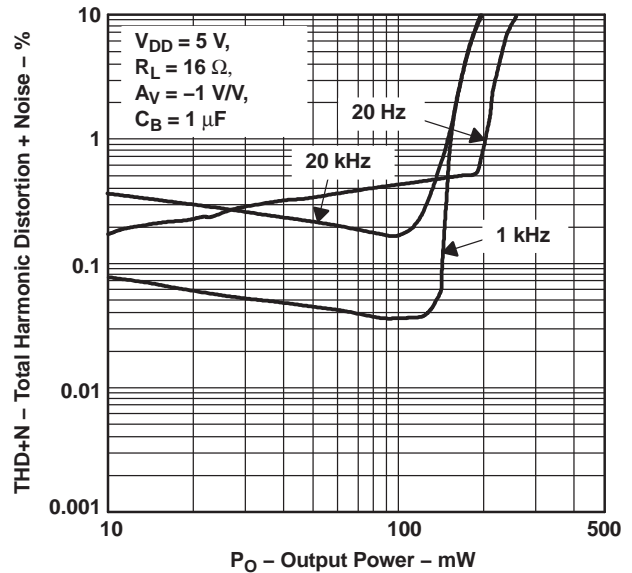

Figure 14.

**SUPPLY RIPPLE REJECTION RATIO
vs
FREQUENCY**

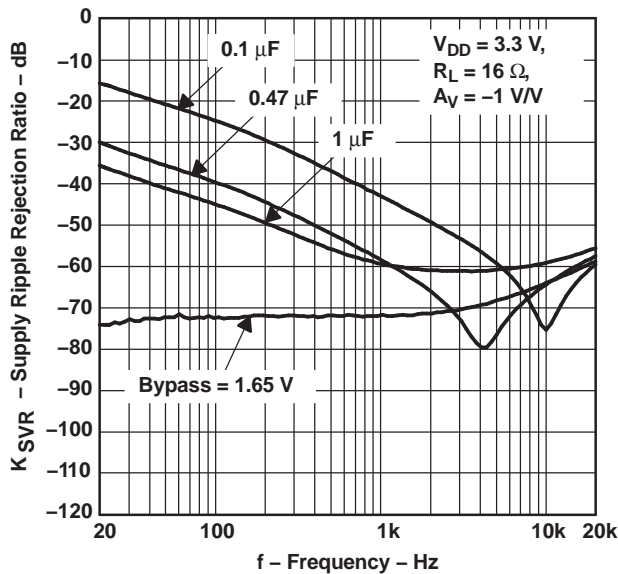

Figure 15.

**SUPPLY RIPPLE REJECTION RATIO
vs
FREQUENCY**

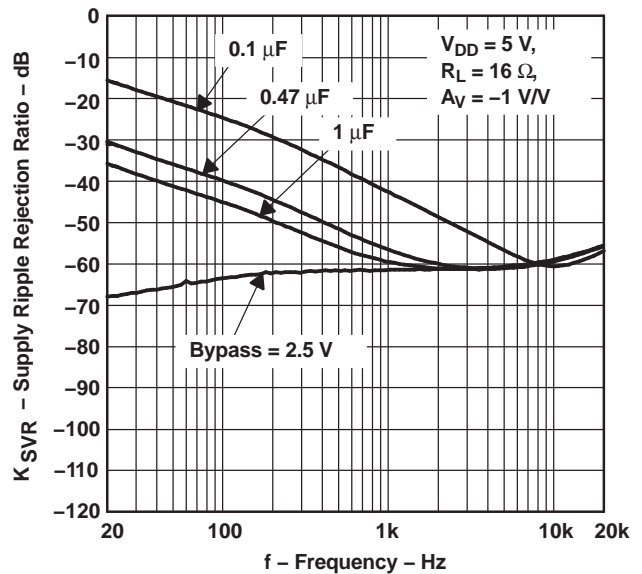

Figure 16.

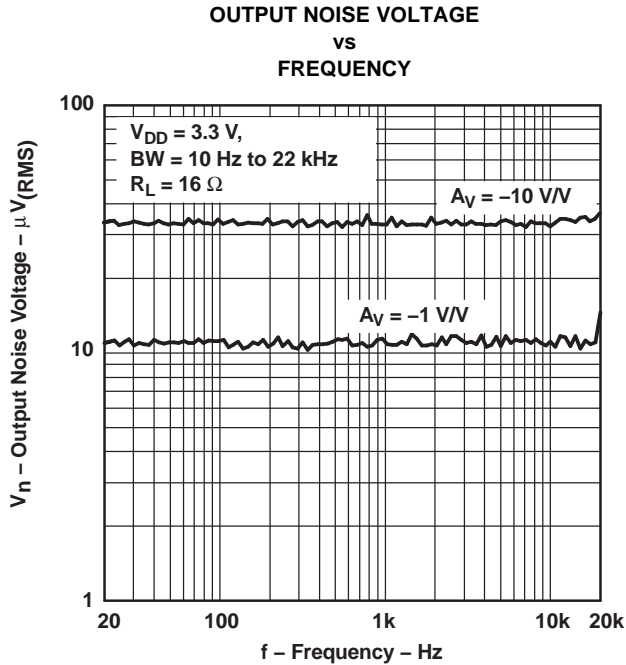

Figure 17.

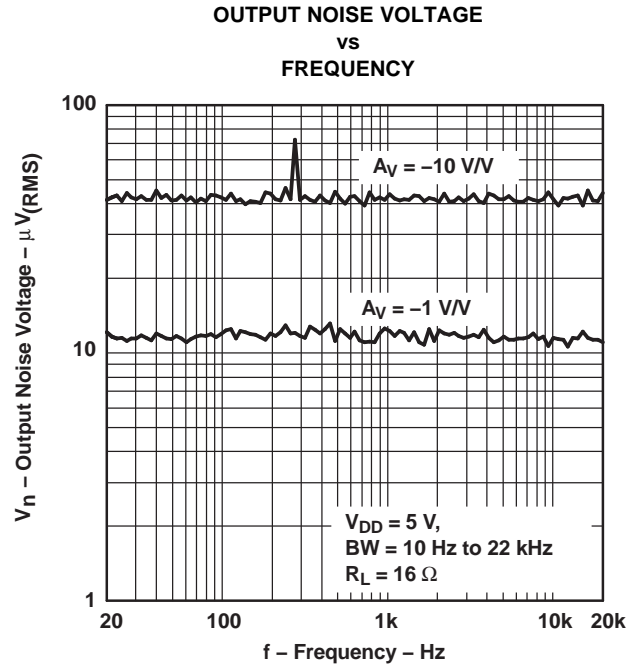

Figure 18.

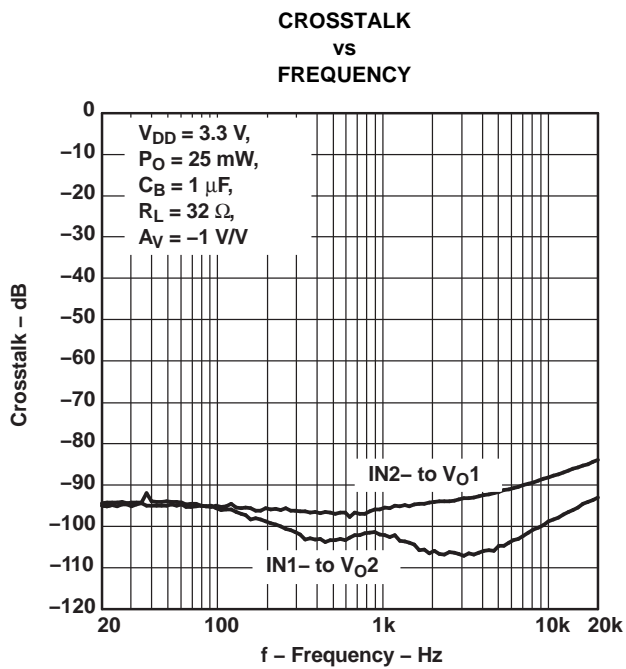

Figure 19.

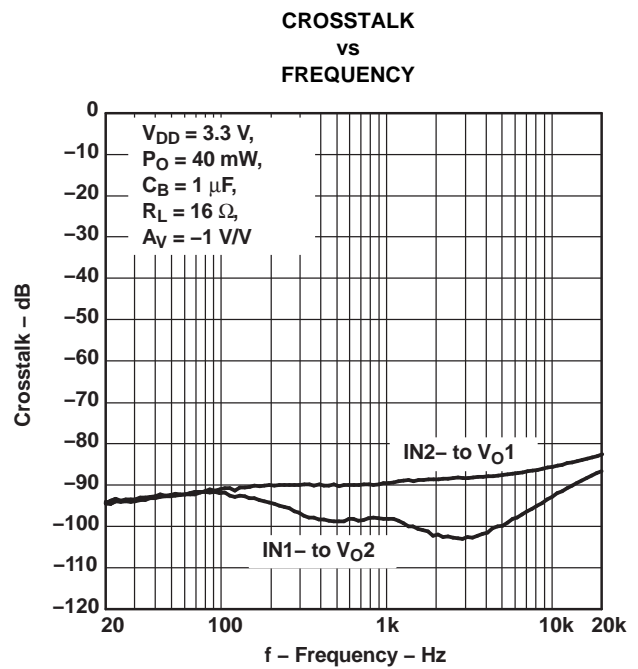

Figure 20.

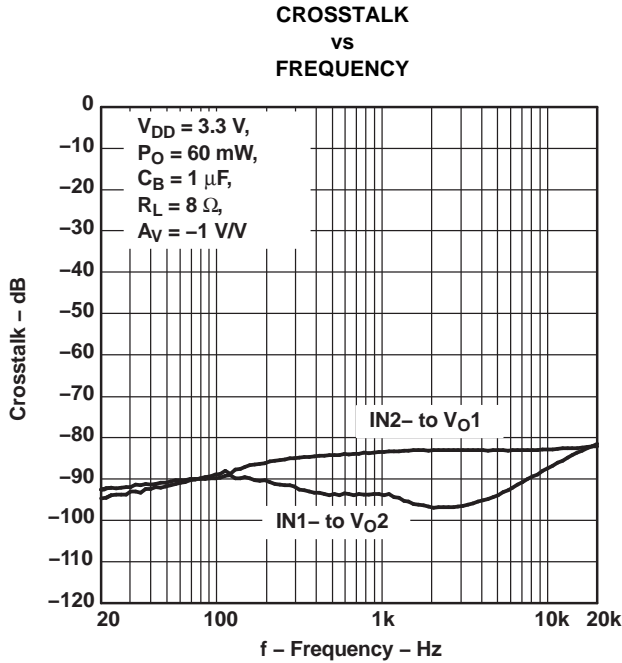

Figure 21.

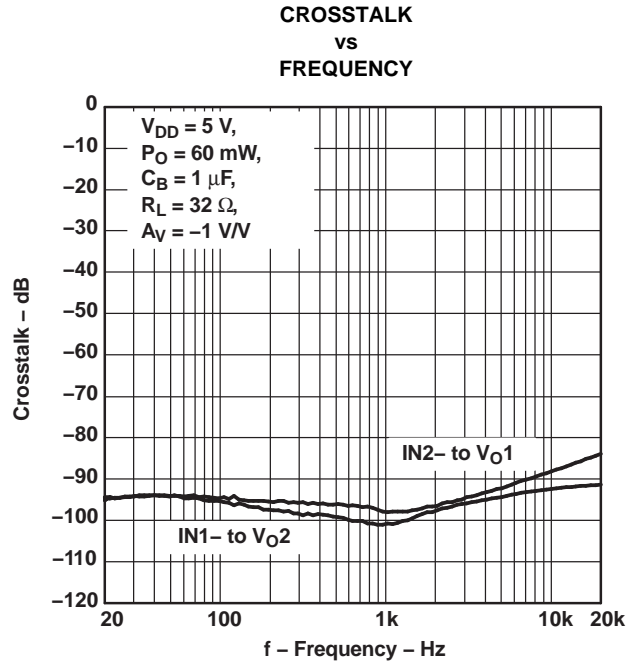

Figure 22.

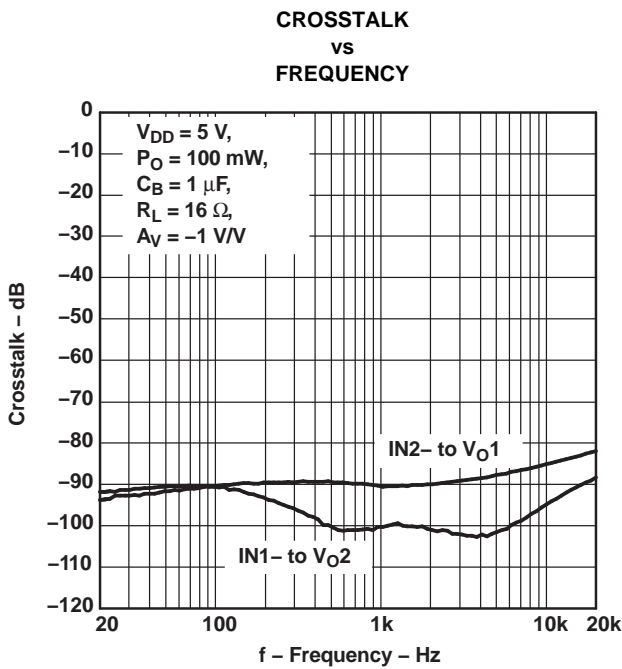

Figure 23.

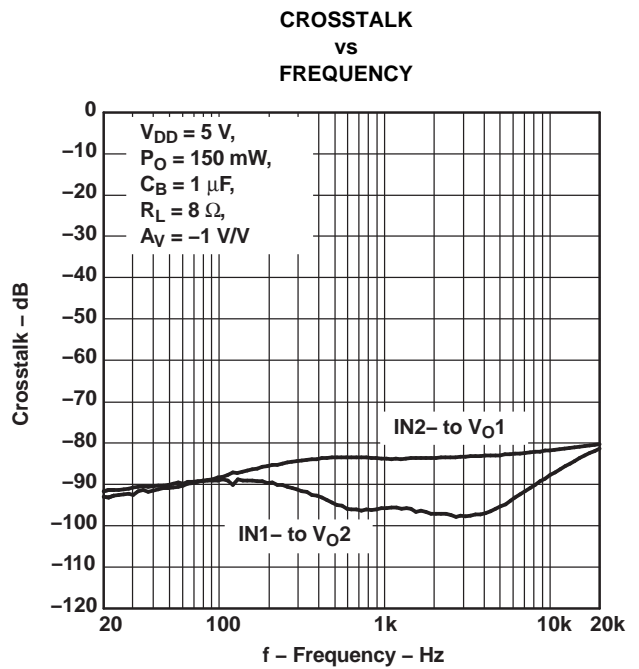

Figure 24.

SHUTDOWN ATTENUATION
vs
FREQUENCY

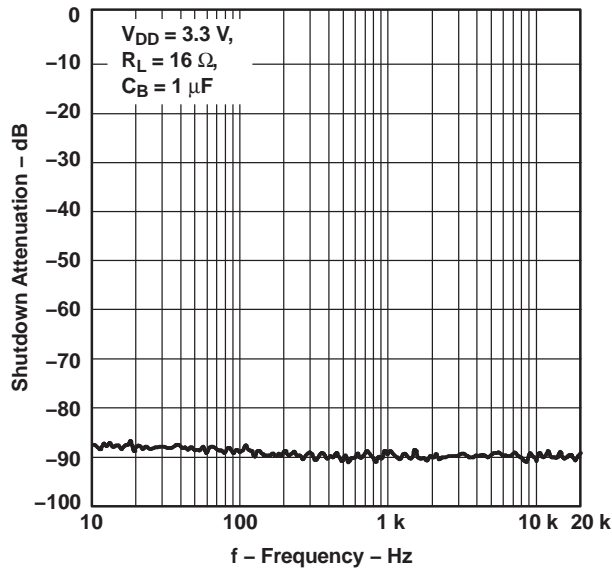

Figure 25.

SHUTDOWN ATTENUATION
vs
FREQUENCY

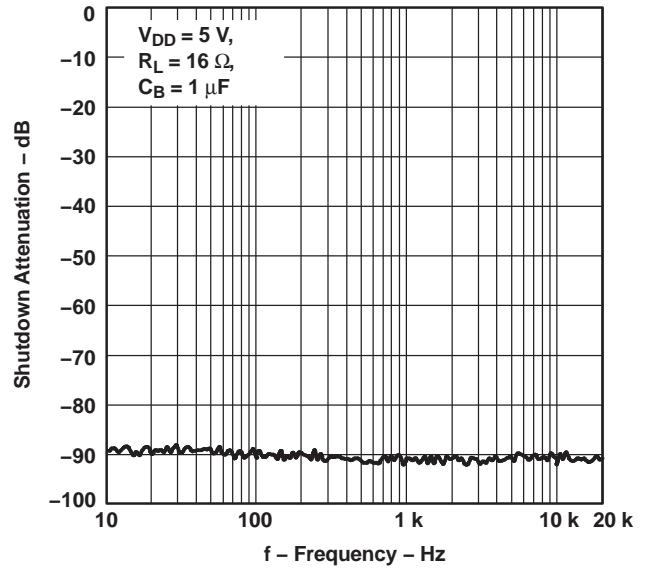

Figure 26.

OPEN-LOOP GAIN AND PHASE MARGIN
vs
FREQUENCY

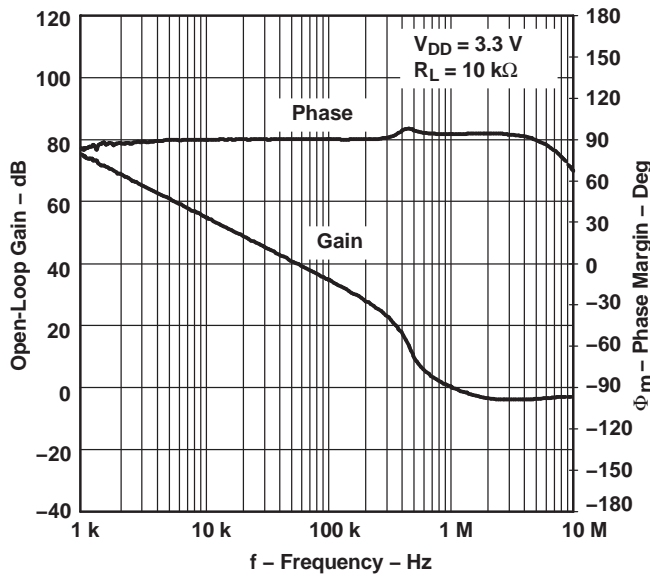

Figure 27.

OPEN-LOOP GAIN AND PHASE MARGIN
vs
FREQUENCY

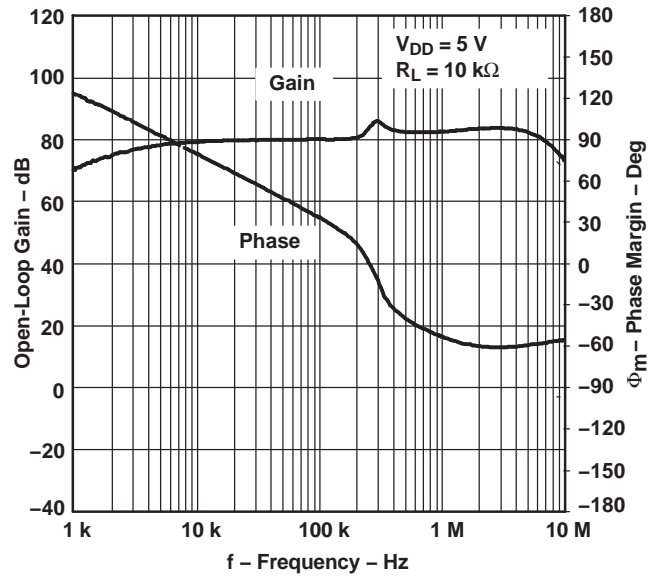

Figure 28.

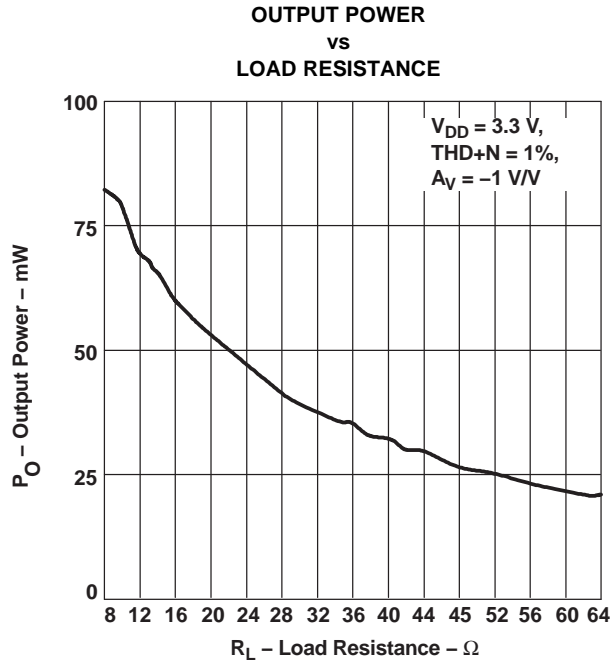

Figure 29.

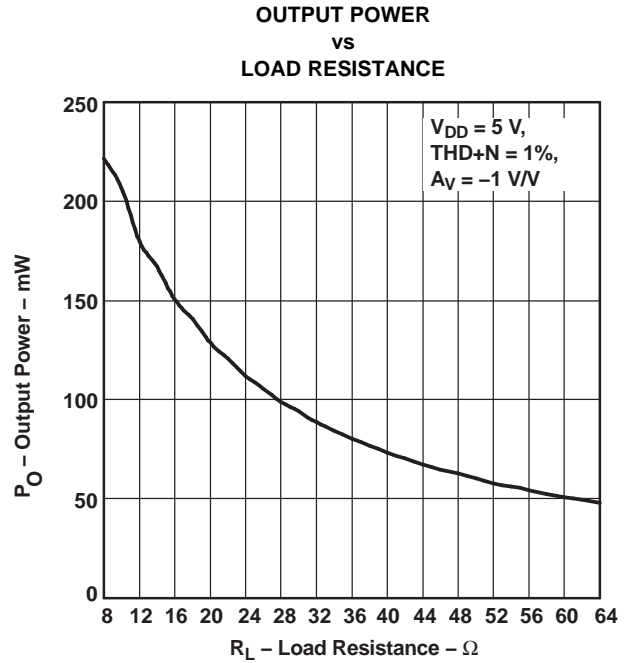

Figure 30.

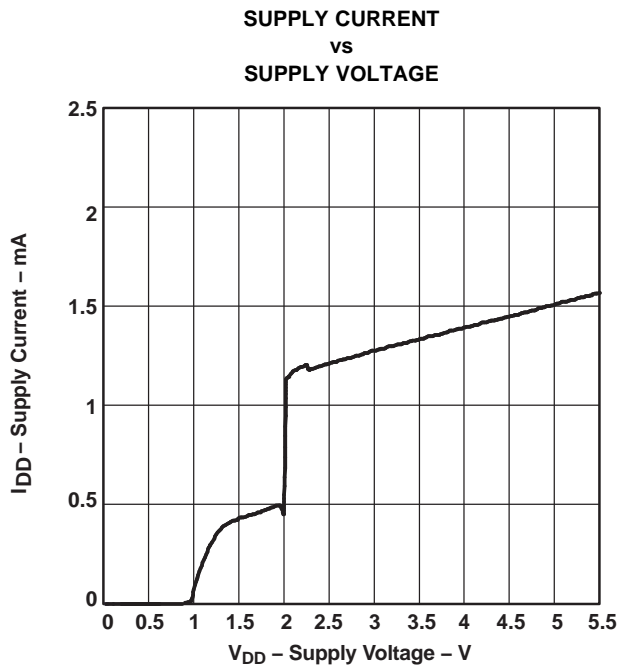

Figure 31.

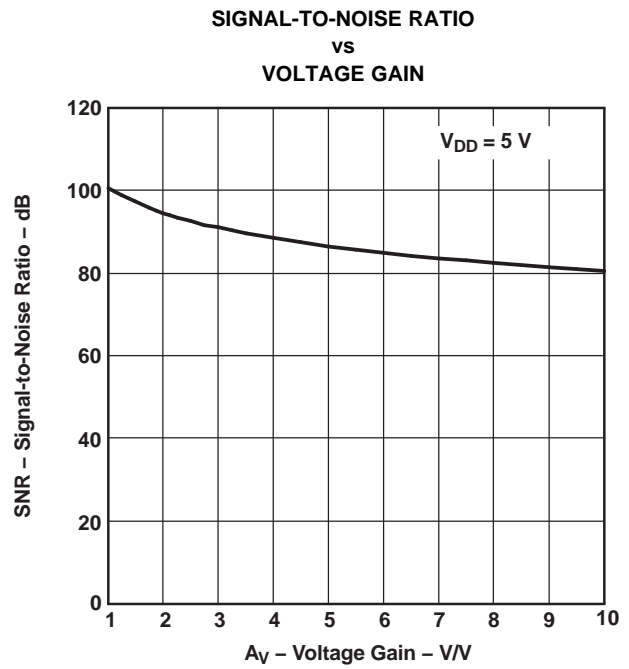
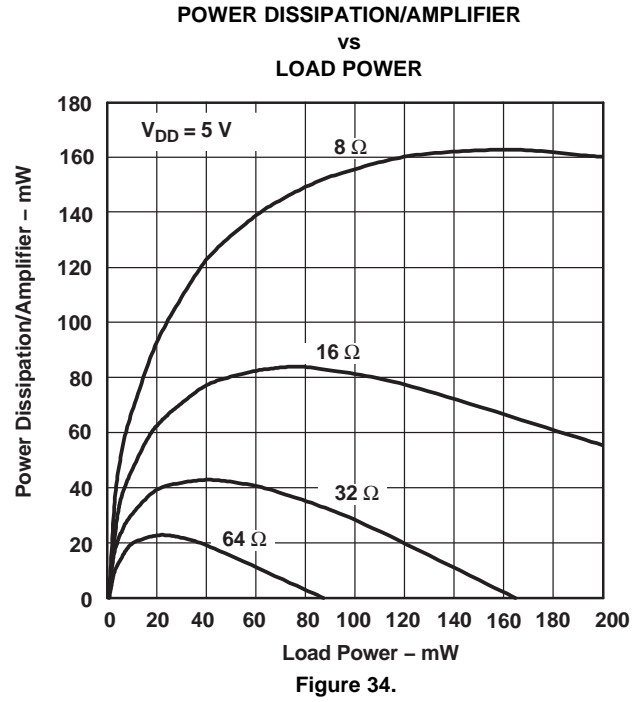
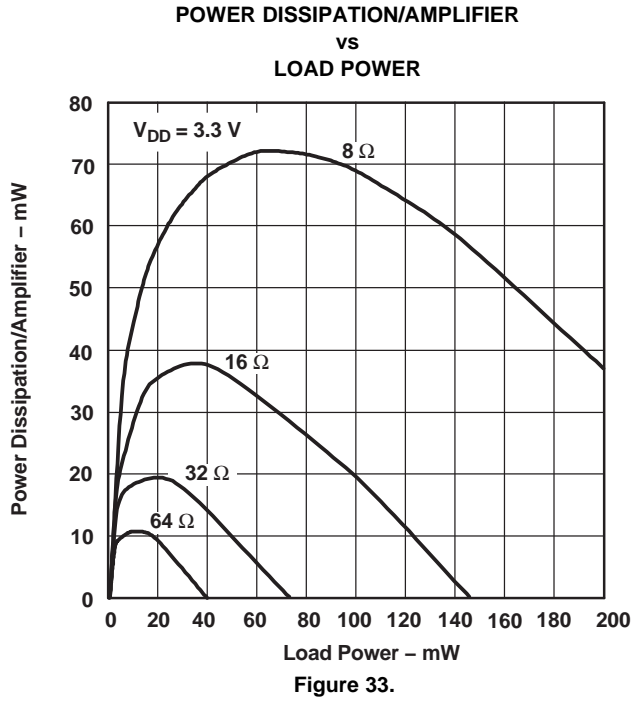

Figure 32.



APPLICATION INFORMATION

GAIN SETTING RESISTORS, R_f and R_i

The gain for the TPA6110A2 is set by resistors R_f and R_i according to [Equation 1](#).

$$\text{Gain} = - \left(\frac{R_f}{R_i} \right) \quad (1)$$

Given that the TPA6110A2 is a MOS amplifier, the input impedance is very high. Consequently input leakage currents are not generally a concern. However, noise in the circuit increases as the value of R_f increases. In addition, a certain range of R_f values is required for proper start-up operation of the amplifier. Considering these factors, it is recommended that the effective impedance seen by the inverting node of the amplifier be set between 5 k Ω and 20 k Ω . The effective impedance is calculated using [Equation 2](#).

$$\text{Effective Impedance} = \frac{R_f R_i}{R_f + R_i} \quad (2)$$

For example, if the input resistance is 20 k Ω and the feedback resistor is 20 k Ω , the gain of the amplifier is -1, and the effective impedance at the inverting terminal is 10 k Ω , a value within the recommended range.

For high performance applications, metal-film resistors are recommended because they tend to have lower noise levels than carbon resistors. For values of R_f above 50 k Ω , the amplifier tends to become unstable due to a pole formed from R_f and the inherent input capacitance of the MOS input structure. For this reason, a small compensation capacitor of approximately 5 pF should be placed in parallel with R_f . This, in effect, creates a low-pass filter network with the cutoff frequency defined by [Equation 3](#).

$$f_{c(\text{lowpass})} = \frac{1}{2\pi R_f C_F} \quad (3)$$

For example, if R_f is 100 k Ω and C_F is 5 pF then $f_{c(\text{lowpass})}$ is 318 kHz, which is well outside the audio range.

INPUT CAPACITOR, C_i

In the typical application, an input capacitor, C_i , is required to allow the amplifier to bias the input signal to the proper dc level for optimum operation. In this case, C_i and R_i form a high-pass filter with the corner frequency determined in [Equation 4](#).

$$f_{c(\text{highpass})} = \frac{1}{2\pi R_i C_i} \quad (4)$$

The value of C_i directly affects the bass (low frequency) performance of the circuit. Consider the example where R_i is 20 k Ω and the specification calls for a flat bass response down to 20 Hz. [Equation 4](#) is reconfigured as [Equation 5](#).

$$C_i = \frac{1}{2\pi R_i f_{c(\text{highpass})}} \quad (5)$$

In this example, C_i is 0.40 μF , so one would likely choose a value in the range of 0.47 μF to 1 μF . A further consideration for this capacitor is the leakage path from the input source through the input network formed by R_i , C_i , and the feedback resistor (R_f) to the load. This leakage current creates a dc offset voltage at the input to the amplifier that reduces useful headroom, especially in high-gain applications (gain >10). For this reason a low-leakage tantalum or ceramic capacitor is the best choice. When polarized capacitors are used, connect the positive side of the capacitor to the amplifier input in most applications. The dc level there is held at $V_{DD}/2$ —likely higher than the source dc level. It is important to confirm the capacitor polarity in the application.

POWER SUPPLY DECOUPLING, $C_{(S)}$

The TPA6110A2 is a high-performance CMOS audio amplifier that requires adequate power-supply decoupling to minimize the output total harmonic distortion (THD). Power-supply decoupling also prevents oscillations when long lead lengths are used between the amplifier and the speaker. The optimum decoupling is achieved by using two capacitors of different types that target different types of noise on the power supply leads. For higher frequency transients, spikes, or digital hash on the line, a good low equivalent-series-resistance (ESR) ceramic capacitor, typically 0.1 μF , placed as close as possible to the device V_{DD} lead, works best. For filtering lower-frequency noise signals, a larger aluminum electrolytic capacitor of 10 μF or greater placed near the power amplifier is recommended.

MIDRAIL BYPASS CAPACITOR, $C_{(B)}$

The midrail bypass capacitor, $C_{(B)}$, serves several important functions. During start up, $C_{(B)}$ determines the rate at which the amplifier starts up. This helps to push the start-up pop noise into the subaudible range (so low it can not be heard). The second function is to reduce noise produced by the power supply caused by coupling into the output drive signal. This noise is from the midrail generation circuit internal to the amplifier. The capacitor is fed from a 230-k Ω source inside the amplifier. To keep the start-up pop as low as possible, maintain the relationship shown in [Equation 6](#).

$$\frac{1}{(C_{(B)} \times 230 \text{ k}\Omega)} \leq \frac{1}{(C_i R_i)} \quad (6)$$

Consider an example circuit where $C_{(B)}$ is 1 μF , C_i is 1 μF , and R_i is 20 k Ω . Substituting these values into the equation 9 results in: $6.25 \leq 50$ which satisfies the rule. Bypass capacitor, $C_{(B)}$, values of 0.1 μF to 1 μF ceramic or tantalum low-ESR capacitors are recommended for the best THD and noise performance.

OUTPUT COUPLING CAPACITOR, $C_{(C)}$

In a typical single-supply, single-ended (SE) configuration, an output coupling capacitor ($C_{(C)}$) is required to block the dc bias at the output of the amplifier, thus preventing dc currents in the load. As with the input coupling capacitor, the output coupling capacitor and impedance of the load form a high-pass filter governed by [Equation 7](#).

$$f_c = \frac{1}{2\pi R_L C_{(C)}} \quad (7)$$

The main disadvantage, from a performance standpoint, is that the typically-small load impedance drives the low-frequency corner higher. Large values of $C_{(C)}$ are required to pass low frequencies into the load. Consider the example where a $C_{(C)}$ of 68 μF is chosen and loads vary from 32 Ω to 47 k Ω . [Table 1](#) summarizes the frequency response characteristics of each configuration.

Table 1. Common Load Impedances vs Low-Frequency Output Characteristics in SE Mode

R_L	$C_{(C)}$	LOWEST FREQUENCY
32 Ω	68 μF	73 Hz
10,000 Ω	68 μF	0.23 Hz
47,000 Ω	68 μF	0.05 Hz

As [Table 1](#) indicates, headphone response is adequate, and drive into line level inputs (a home stereo for example) is very good.

The output coupling capacitor required in single-supply SE mode also places additional constraints on the selection of other components in the amplifier circuit. With the rules described earlier still valid, add the following relationship:

$$\frac{1}{(C_{(B)} \times 230 \text{ k}\Omega)} \leq \frac{1}{(C_i R_i)} \ll \frac{1}{R_L C_{(C)}} \quad (8)$$

USING LOW-ESR CAPACITORS

Low-ESR capacitors are recommended throughout this application. A real capacitor can be modeled simply as a resistor in series with an ideal capacitor. The voltage drop across this resistor minimizes the beneficial effects of the capacitor in the circuit. The lower the equivalent value of this resistance, the more the real capacitor behaves like an ideal capacitor.

5-V VERSUS 3.3-V OPERATION

The TPA6110A2 was designed for operation over a supply range of 2.5 V to 5.5 V. This data sheet provides full specifications for 5-V and 3.3-V operation, since these are considered to be the two most common supply voltages. There are no special considerations for 3.3-V versus 5-V operation as far as supply bypassing, gain setting, or stability. The most important consideration is that of output power. Each amplifier in the TPA6110A2 can produce a maximum voltage swing of $V_{DD} - 1 \text{ V}$. This means, for 3.3-V operation, clipping starts to occur when $V_{O(PP)} = 2.3 \text{ V}$ as opposed when $V_{O(PP)} = 4 \text{ V}$ while operating at 5 V. The reduced voltage swing subsequently reduces maximum output power into the load before distortion becomes significant.

REVISION HISTORY

Changes from Original (December 2000) to Revision A	Page
• Change the DC ELECTRICAL CHARACTERISTICS table From $T_A = 25^\circ\text{C}$, $V_{DD} = 3.3\text{ V}$ To: $T_A = 25^\circ\text{C}$, $V_{DD} = 2.5\text{ V}$, updated values	3
• Change the DC ELECTRICAL CHARACTERISTICS table From $T_A = 25^\circ\text{C}$, $V_{DD} = 5\text{ V}$ To: $T_A = 25^\circ\text{C}$, $V_{DD} = 5.5\text{ V}$, updated values	3
• Changed Figure 8 , From: $R_L = 8\text{k}\Omega$ To: $R_L = 8\Omega$	6
• Changed Figure 24 , From: frequency limit at 1M To: frequency limit at 20K	10
• Changed Figure 25 , From: frequency limit at 1M To: frequency limit at 20K	11

Changes from Revision A (September 2004) to Revision B	Page
• Changed the DC Electrical Characteristic ($V_{DD} = 2.5\text{V}$) for $I_{DD(SD)}$ From: Typ = 10 Max = 50 To: Typ = 1 Max = 10	3
• Changed the DC Electrical Characteristic ($V_{DD} = 5.5\text{V}$) for $I_{DD(SD)}$ From: Typ = 60 Max = 100 To: Typ = 1 Max = 10	3

PACKAGING INFORMATION

Orderable Device	Status (1)	Package Type	Package Drawing	Pins	Package Qty	Eco Plan (2)	Lead/Ball Finish (6)	MSL Peak Temp (3)	Op Temp (°C)	Device Marking (4/5)	Samples
TPA6110A2DGN	ACTIVE	MSOP-PowerPAD	DGN	8	80	Green (RoHS & no Sb/Br)	CU NIPDAU CU NIPDAUAG	Level-1-260C-UNLIM	-40 to 85	AIZ	Samples
TPA6110A2DGNG4	ACTIVE	MSOP-PowerPAD	DGN	8	80	Green (RoHS & no Sb/Br)	CU NIPDAUAG	Level-1-260C-UNLIM	-40 to 85	AIZ	Samples
TPA6110A2DGNR	ACTIVE	MSOP-PowerPAD	DGN	8	2500	Green (RoHS & no Sb/Br)	CU NIPDAU CU NIPDAUAG	Level-1-260C-UNLIM	-40 to 85	AIZ	Samples
TPA6110A2DGNRG4	ACTIVE	MSOP-PowerPAD	DGN	8	2500	Green (RoHS & no Sb/Br)	CU NIPDAU	Level-1-260C-UNLIM	-40 to 85	AIZ	Samples

(1) The marketing status values are defined as follows:

ACTIVE: Product device recommended for new designs.

LIFEBUY: TI has announced that the device will be discontinued, and a lifetime-buy period is in effect.

NRND: Not recommended for new designs. Device is in production to support existing customers, but TI does not recommend using this part in a new design.

PREVIEW: Device has been announced but is not in production. Samples may or may not be available.

OBSOLETE: TI has discontinued the production of the device.

(2) **RoHS:** TI defines "RoHS" to mean semiconductor products that are compliant with the current EU RoHS requirements for all 10 RoHS substances, including the requirement that RoHS substance do not exceed 0.1% by weight in homogeneous materials. Where designed to be soldered at high temperatures, "RoHS" products are suitable for use in specified lead-free processes. TI may reference these types of products as "Pb-Free".

RoHS Exempt: TI defines "RoHS Exempt" to mean products that contain lead but are compliant with EU RoHS pursuant to a specific EU RoHS exemption.

Green: TI defines "Green" to mean the content of Chlorine (Cl) and Bromine (Br) based flame retardants meet JS709B low halogen requirements of <=1000ppm threshold. Antimony trioxide based flame retardants must also meet the <=1000ppm threshold requirement.

(3) MSL, Peak Temp. - The Moisture Sensitivity Level rating according to the JEDEC industry standard classifications, and peak solder temperature.

(4) There may be additional marking, which relates to the logo, the lot trace code information, or the environmental category on the device.

(5) Multiple Device Markings will be inside parentheses. Only one Device Marking contained in parentheses and separated by a "-" will appear on a device. If a line is indented then it is a continuation of the previous line and the two combined represent the entire Device Marking for that device.

(6) Lead/Ball Finish - Orderable Devices may have multiple material finish options. Finish options are separated by a vertical ruled line. Lead/Ball Finish values may wrap to two lines if the finish value exceeds the maximum column width.

Important Information and Disclaimer: The information provided on this page represents TI's knowledge and belief as of the date that it is provided. TI bases its knowledge and belief on information provided by third parties, and makes no representation or warranty as to the accuracy of such information. Efforts are underway to better integrate information from third parties. TI has taken and

continues to take reasonable steps to provide representative and accurate information but may not have conducted destructive testing or chemical analysis on incoming materials and chemicals. TI and TI suppliers consider certain information to be proprietary, and thus CAS numbers and other limited information may not be available for release.

In no event shall TI's liability arising out of such information exceed the total purchase price of the TI part(s) at issue in this document sold by TI to Customer on an annual basis.

TAPE AND REEL INFORMATION



QUADRANT ASSIGNMENTS FOR PIN 1 ORIENTATION IN TAPE



*All dimensions are nominal

Device	Package Type	Package Drawing	Pins	SPQ	Reel Diameter (mm)	Reel Width W1 (mm)	A0 (mm)	B0 (mm)	K0 (mm)	P1 (mm)	W (mm)	Pin1 Quadrant
TPA6110A2DGNR	MSOP-Power PAD	DGN	8	2500	330.0	12.4	5.3	3.4	1.4	8.0	12.0	Q1
TPA6110A2DGNR	MSOP-Power PAD	DGN	8	2500	330.0	12.4	5.3	3.4	1.4	8.0	12.0	Q1

TAPE AND REEL BOX DIMENSIONS

*All dimensions are nominal

Device	Package Type	Package Drawing	Pins	SPQ	Length (mm)	Width (mm)	Height (mm)
TPA6110A2DGNR	MSOP-PowerPAD	DGN	8	2500	358.0	335.0	35.0
TPA6110A2DGNR	MSOP-PowerPAD	DGN	8	2500	364.0	364.0	27.0

DGN (S-PDSO-G8)

PowerPAD™ PLASTIC SMALL OUTLINE



- NOTES:
- All linear dimensions are in millimeters.
 - This drawing is subject to change without notice.
 - Body dimensions do not include mold flash or protrusion.
 - This package is designed to be soldered to a thermal pad on the board. Refer to Technical Brief, PowerPad Thermally Enhanced Package, Texas Instruments Literature No. SLMA002 for information regarding recommended board layout. This document is available at www.ti.com <<http://www.ti.com>>.
 - See the additional figure in the Product Data Sheet for details regarding the exposed thermal pad features and dimensions.
 - Falls within JEDEC MO-187 variation AA-T

PowerPAD is a trademark of Texas Instruments.

DGN (S-PDSO-G8)

PowerPAD™ PLASTIC SMALL OUTLINE

THERMAL INFORMATION

This PowerPAD™ package incorporates an exposed thermal pad that is designed to be attached to a printed circuit board (PCB). The thermal pad must be soldered directly to the PCB. After soldering, the PCB can be used as a heatsink. In addition, through the use of thermal vias, the thermal pad can be attached directly to the appropriate copper plane shown in the electrical schematic for the device, or alternatively, can be attached to a special heatsink structure designed into the PCB. This design optimizes the heat transfer from the integrated circuit (IC).

For additional information on the PowerPAD package and how to take advantage of its heat dissipating abilities, refer to Technical Brief, PowerPAD Thermally Enhanced Package, Texas Instruments Literature No. SLMA002 and Application Brief, PowerPAD Made Easy, Texas Instruments Literature No. SLMA004. Both documents are available at www.ti.com.

The exposed thermal pad dimensions for this package are shown in the following illustration.

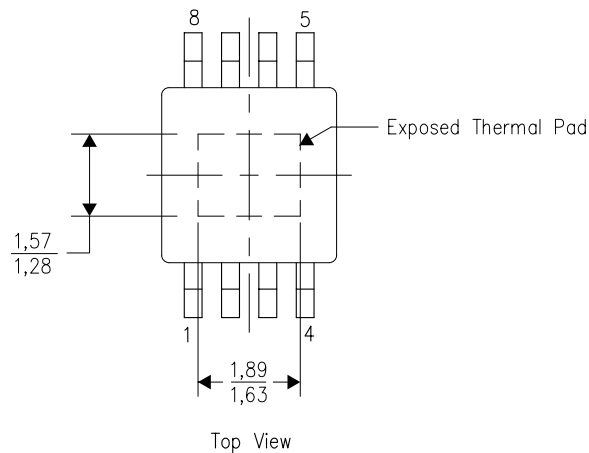

Exposed Thermal Pad Dimensions

4206323-2/1 12/11

NOTE: All linear dimensions are in millimeters

PowerPAD is a trademark of Texas Instruments

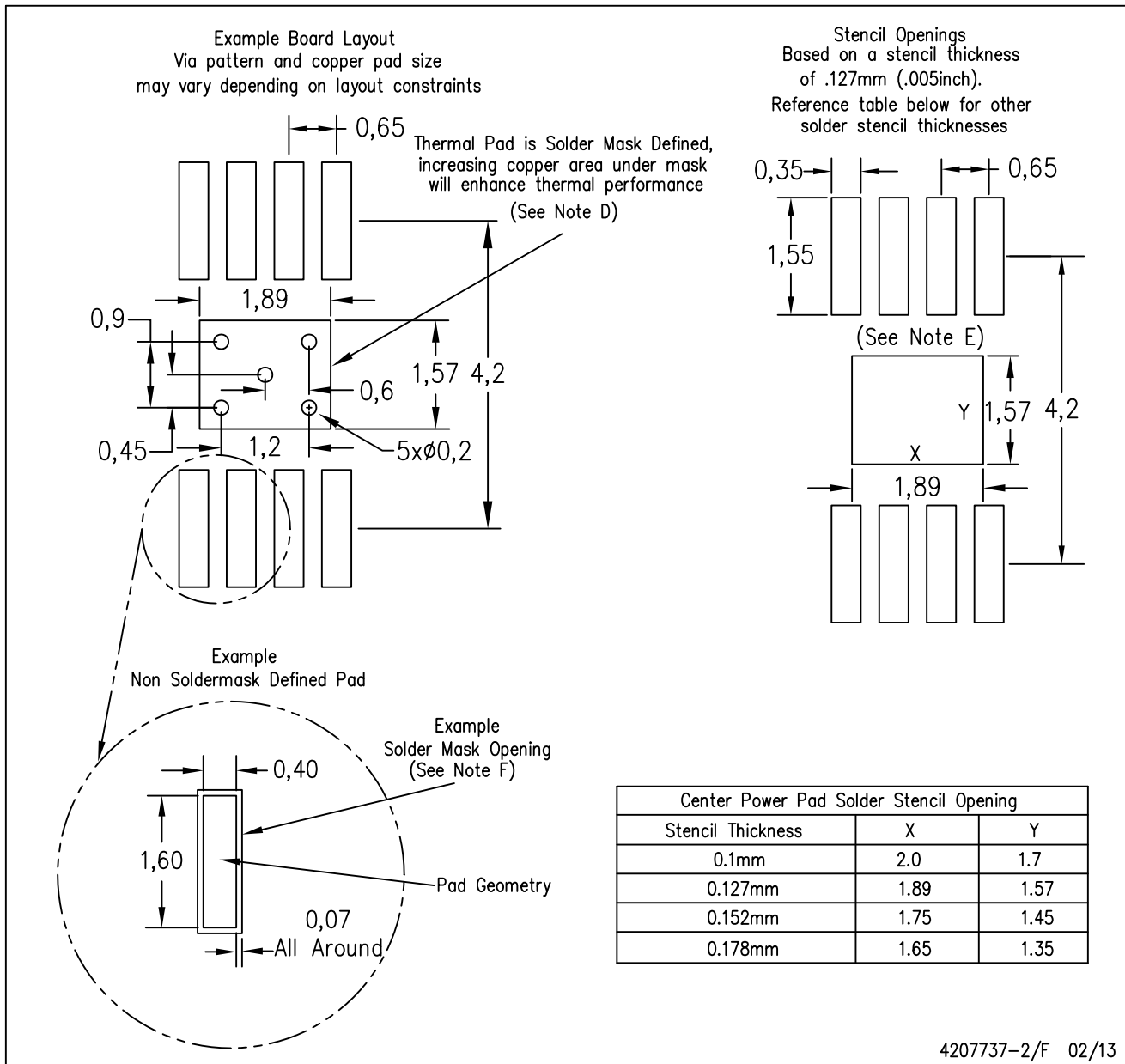

- NOTES:
- A. All linear dimensions are in millimeters.
 - B. This drawing is subject to change without notice.
 - C. Customers should place a note on the circuit board fabrication drawing not to alter the center solder mask defined pad.
 - D. This package is designed to be soldered to a thermal pad on the board. Refer to Technical Brief, PowerPad Thermally Enhanced Package, Texas Instruments Literature No. SLMA002, SLMA004, and also the Product Data Sheets for specific thermal information, via requirements, and recommended board layout. These documents are available at www.ti.com <<http://www.ti.com>>.
 - E. Laser cutting apertures with trapezoidal walls and also rounding corners will offer better paste release. Customers should contact their board assembly site for stencil design recommendations. Example stencil design based on a 50% volumetric metal load solder paste. Refer to IPC-7525 for other stencil recommendations.
 - F. Customers should contact their board fabrication site for solder mask tolerances between and around signal pads.

PowerPAD is a trademark of Texas Instruments

IMPORTANT NOTICE

Texas Instruments Incorporated (TI) reserves the right to make corrections, enhancements, improvements and other changes to its semiconductor products and services per JESD46, latest issue, and to discontinue any product or service per JESD48, latest issue. Buyers should obtain the latest relevant information before placing orders and should verify that such information is current and complete.

TI's published terms of sale for semiconductor products (<http://www.ti.com/sc/docs/stdterms.htm>) apply to the sale of packaged integrated circuit products that TI has qualified and released to market. Additional terms may apply to the use or sale of other types of TI products and services.

Reproduction of significant portions of TI information in TI data sheets is permissible only if reproduction is without alteration and is accompanied by all associated warranties, conditions, limitations, and notices. TI is not responsible or liable for such reproduced documentation. Information of third parties may be subject to additional restrictions. Resale of TI products or services with statements different from or beyond the parameters stated by TI for that product or service voids all express and any implied warranties for the associated TI product or service and is an unfair and deceptive business practice. TI is not responsible or liable for any such statements.

Buyers and others who are developing systems that incorporate TI products (collectively, "Designers") understand and agree that Designers remain responsible for using their independent analysis, evaluation and judgment in designing their applications and that Designers have full and exclusive responsibility to assure the safety of Designers' applications and compliance of their applications (and of all TI products used in or for Designers' applications) with all applicable regulations, laws and other applicable requirements. Designer represents that, with respect to their applications, Designer has all the necessary expertise to create and implement safeguards that (1) anticipate dangerous consequences of failures, (2) monitor failures and their consequences, and (3) lessen the likelihood of failures that might cause harm and take appropriate actions. Designer agrees that prior to using or distributing any applications that include TI products, Designer will thoroughly test such applications and the functionality of such TI products as used in such applications.

TI's provision of technical, application or other design advice, quality characterization, reliability data or other services or information, including, but not limited to, reference designs and materials relating to evaluation modules, (collectively, "TI Resources") are intended to assist designers who are developing applications that incorporate TI products; by downloading, accessing or using TI Resources in any way, Designer (individually or, if Designer is acting on behalf of a company, Designer's company) agrees to use any particular TI Resource solely for this purpose and subject to the terms of this Notice.

TI's provision of TI Resources does not expand or otherwise alter TI's applicable published warranties or warranty disclaimers for TI products, and no additional obligations or liabilities arise from TI providing such TI Resources. TI reserves the right to make corrections, enhancements, improvements and other changes to its TI Resources. TI has not conducted any testing other than that specifically described in the published documentation for a particular TI Resource.

Designer is authorized to use, copy and modify any individual TI Resource only in connection with the development of applications that include the TI product(s) identified in such TI Resource. NO OTHER LICENSE, EXPRESS OR IMPLIED, BY ESTOPPEL OR OTHERWISE TO ANY OTHER TI INTELLECTUAL PROPERTY RIGHT, AND NO LICENSE TO ANY TECHNOLOGY OR INTELLECTUAL PROPERTY RIGHT OF TI OR ANY THIRD PARTY IS GRANTED HEREIN, including but not limited to any patent right, copyright, mask work right, or other intellectual property right relating to any combination, machine, or process in which TI products or services are used. Information regarding or referencing third-party products or services does not constitute a license to use such products or services, or a warranty or endorsement thereof. Use of TI Resources may require a license from a third party under the patents or other intellectual property of the third party, or a license from TI under the patents or other intellectual property of TI.

TI RESOURCES ARE PROVIDED "AS IS" AND WITH ALL FAULTS. TI DISCLAIMS ALL OTHER WARRANTIES OR REPRESENTATIONS, EXPRESS OR IMPLIED, REGARDING RESOURCES OR USE THEREOF, INCLUDING BUT NOT LIMITED TO ACCURACY OR COMPLETENESS, TITLE, ANY EPIDEMIC FAILURE WARRANTY AND ANY IMPLIED WARRANTIES OF MERCHANTABILITY, FITNESS FOR A PARTICULAR PURPOSE, AND NON-INFRINGEMENT OF ANY THIRD PARTY INTELLECTUAL PROPERTY RIGHTS. TI SHALL NOT BE LIABLE FOR AND SHALL NOT DEFEND OR INDEMNIFY DESIGNER AGAINST ANY CLAIM, INCLUDING BUT NOT LIMITED TO ANY INFRINGEMENT CLAIM THAT RELATES TO OR IS BASED ON ANY COMBINATION OF PRODUCTS EVEN IF DESCRIBED IN TI RESOURCES OR OTHERWISE. IN NO EVENT SHALL TI BE LIABLE FOR ANY ACTUAL, DIRECT, SPECIAL, COLLATERAL, INDIRECT, PUNITIVE, INCIDENTAL, CONSEQUENTIAL OR EXEMPLARY DAMAGES IN CONNECTION WITH OR ARISING OUT OF TI RESOURCES OR USE THEREOF, AND REGARDLESS OF WHETHER TI HAS BEEN ADVISED OF THE POSSIBILITY OF SUCH DAMAGES.

Unless TI has explicitly designated an individual product as meeting the requirements of a particular industry standard (e.g., ISO/TS 16949 and ISO 26262), TI is not responsible for any failure to meet such industry standard requirements.

Where TI specifically promotes products as facilitating functional safety or as compliant with industry functional safety standards, such products are intended to help enable customers to design and create their own applications that meet applicable functional safety standards and requirements. Using products in an application does not by itself establish any safety features in the application. Designers must ensure compliance with safety-related requirements and standards applicable to their applications. Designer may not use any TI products in life-critical medical equipment unless authorized officers of the parties have executed a special contract specifically governing such use. Life-critical medical equipment is medical equipment where failure of such equipment would cause serious bodily injury or death (e.g., life support, pacemakers, defibrillators, heart pumps, neurostimulators, and implantables). Such equipment includes, without limitation, all medical devices identified by the U.S. Food and Drug Administration as Class III devices and equivalent classifications outside the U.S.

TI may expressly designate certain products as completing a particular qualification (e.g., Q100, Military Grade, or Enhanced Product). Designers agree that it has the necessary expertise to select the product with the appropriate qualification designation for their applications and that proper product selection is at Designers' own risk. Designers are solely responsible for compliance with all legal and regulatory requirements in connection with such selection.

Designer will fully indemnify TI and its representatives against any damages, costs, losses, and/or liabilities arising out of Designer's non-compliance with the terms and provisions of this Notice.