

## Surface Mount Schottky Barrier Rectifier

Reverse Voltage - 40 and 60V    Forward Current - 5.0A

### FEATURES

- Metal silicon junction, majority carrier conduction
- For surface mounted applications
- Low power loss, high efficiency
- High forward surge current capability
- For use in low voltage, high frequency inverters, free wheeling, and polarity protection applications

### MECHANICAL DATA

- Case: SMAF
- Terminals: Solderable per MIL-STD-750, Method 2026
- Approx. Weight: 27mg 0.00086oz

### Absolute Maximum Ratings and Electrical characteristics

Ratings at 25°C ambient temperature unless otherwise specified. Single phase, half wave, 60Hz resistive or inductive load, for capacitive load, derate by 20 %

### PINNING

PIN	DESCRIPTION
1	Cathode
2	Anode

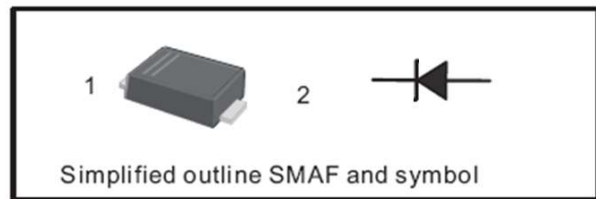

Parameter	Symbols	SS54FL	SS56FL	Units
Maximum Repetitive Peak Reverse Voltage	$V_{RRM}$	40	60	V
Maximum RMS voltage	$V_{RMS}$	28	42	V
Maximum DC Blocking Voltage	$V_{DC}$	40	60	V
Maximum Average Forward Rectified Current	$I_{F(AV)}$	5.0		A
Peak Forward Surge Current, 8.3ms Single Half Sine-wave Superimposed on Rated Load (JEDEC method)	$I_{FSM}$	150		A
Max Instantaneous Forward Voltage at 5 A	$V_F$	0.45	0.55	V
Maximum DC Reverse Current $T_a = 25^\circ\text{C}$ at Rated DC Reverse Voltage $T_a = 100^\circ\text{C}$	$I_R$	1.0 50		mA
Typical Junction Capacitance <sup>1)</sup>	$C_j$	800	500	pF
Typical Thermal Resistance <sup>2)</sup>	$R_{\theta JA}$	55		$^\circ\text{C}/\text{W}$
Operating Junction Temperature Range	$T_j$	-55 ~ +125		$^\circ\text{C}$
Storage Temperature Range	$T_{stg}$	-55 ~ +150		$^\circ\text{C}$

1) Measured at 1MHz and applied reverse voltage of 4 V D.C.

2) P.C.B. mounted with 0.2 X 0.2" (5 X 5 mm) copper pad areas.

SHIKE MAKE CONSCIOUS PRODUCT

CONSCIOUS PRODUCTS BEGIN WITH CONSCIOUS PEOPLE

REV.07



www.shike.tw

Fig.1 Forward Current Derating Curve

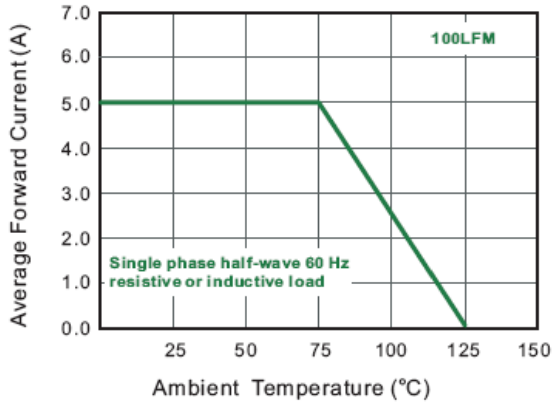

Fig.2 Typical Reverse Characteristics

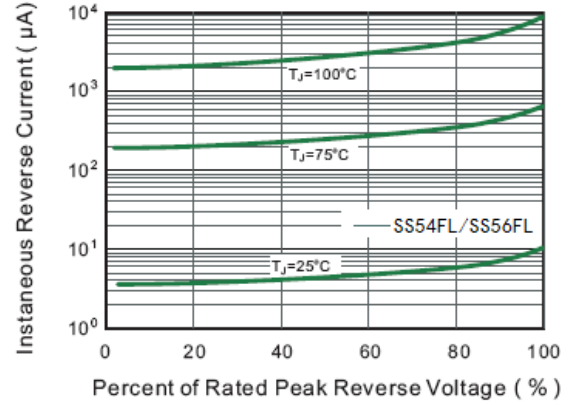

Fig.3 Typical Forward Characteristic

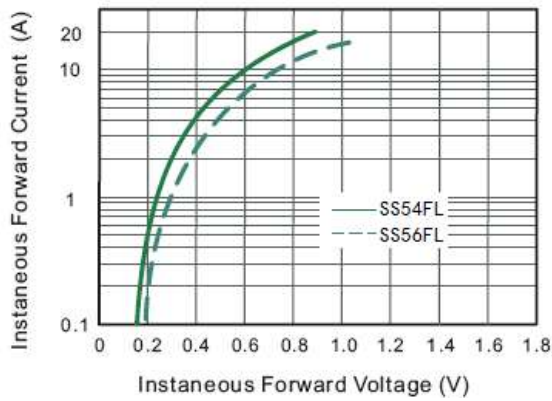

Fig.4 Typical Junction Capacitance

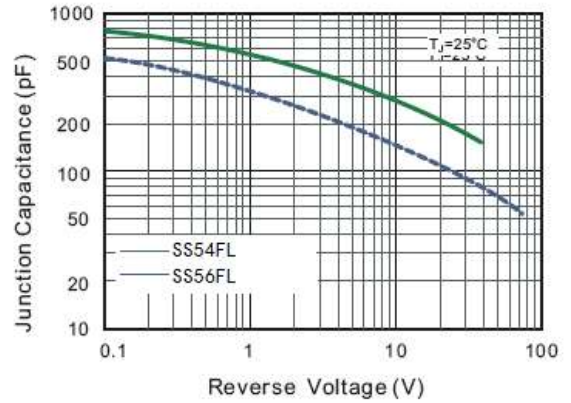

Fig.5 Maximum Non-Repetitive Peak Forward Surge Current

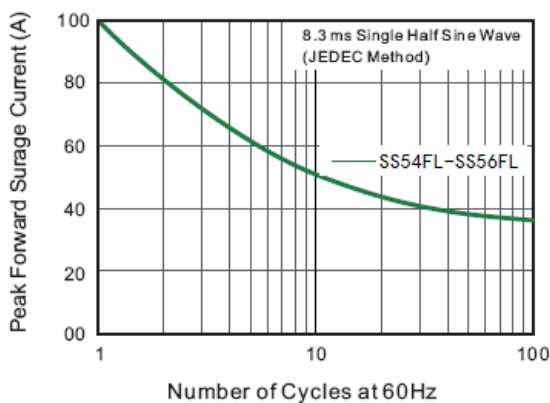
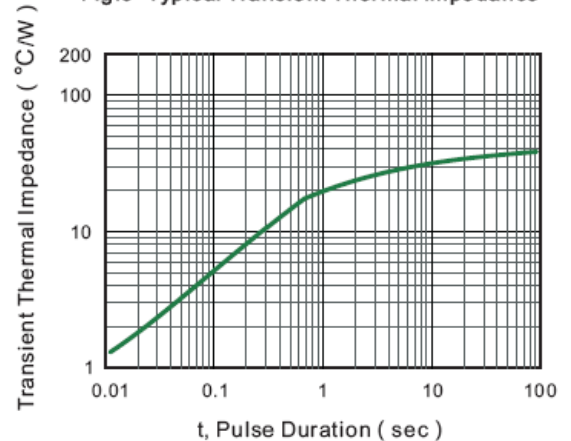

Fig.6- Typical Transient Thermal Impedance



## PACKAGE OUTLINE

Plastic surface mounted package; 2 leads

SMAF

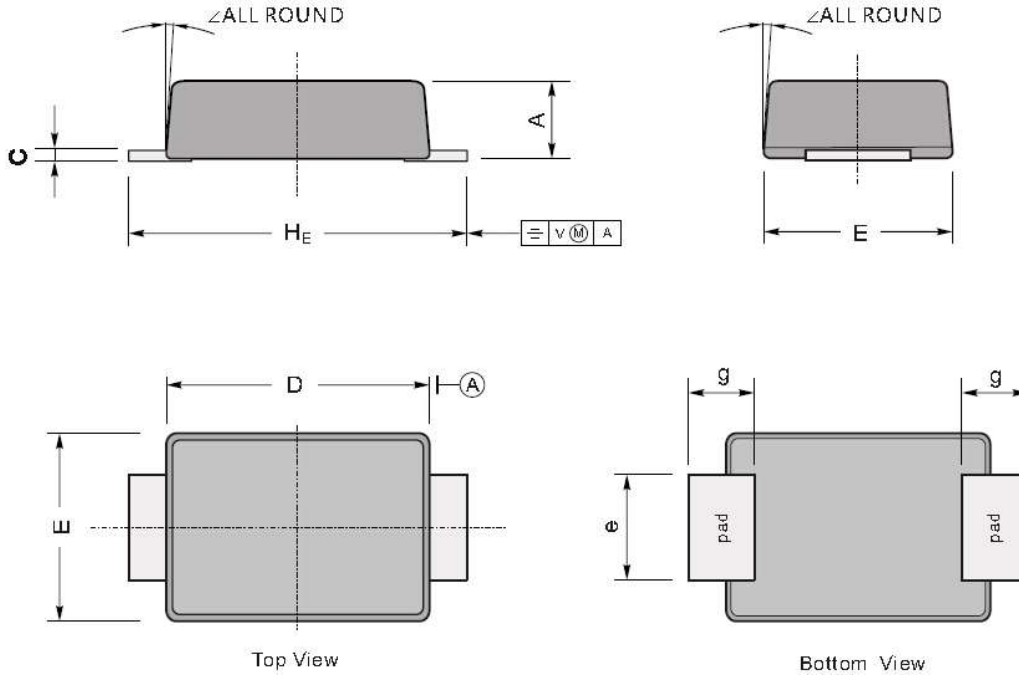

UNIT		A	C	D	E	e	g	H <sub>E</sub>	$\angle$
mm	max	1.1	0.20	3.7	2.7	1.6	1.2	4.9	7°
	min	0.9	0.12	3.3	2.4	1.3	0.8	4.4	
mil	max	43	7.9	146	106	63	47	193	
	min	35	4.7	130	94	51	31	173	

### The recommended mounting pad size

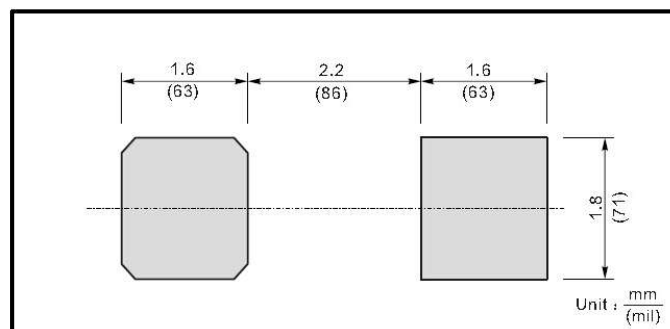

SHIKE MAKE CONSCIOUS PRODUCT

CONSCIOUS PRODUCTS BEGIN WITH CONSCIOUS PEOPLE

REV.07



www.shike.tw