

1. Features

- n $R_{DS(on)}=4.0m\Omega$ (typ.) @ $V_{GS}=10V$
- n 100% avalanche tested
- n Reliable and rugged
- n Lead free and green device available (RoHS Compliant)

2. Applications

- n Switching application
- n Power management for inverter systems

3.Symbol

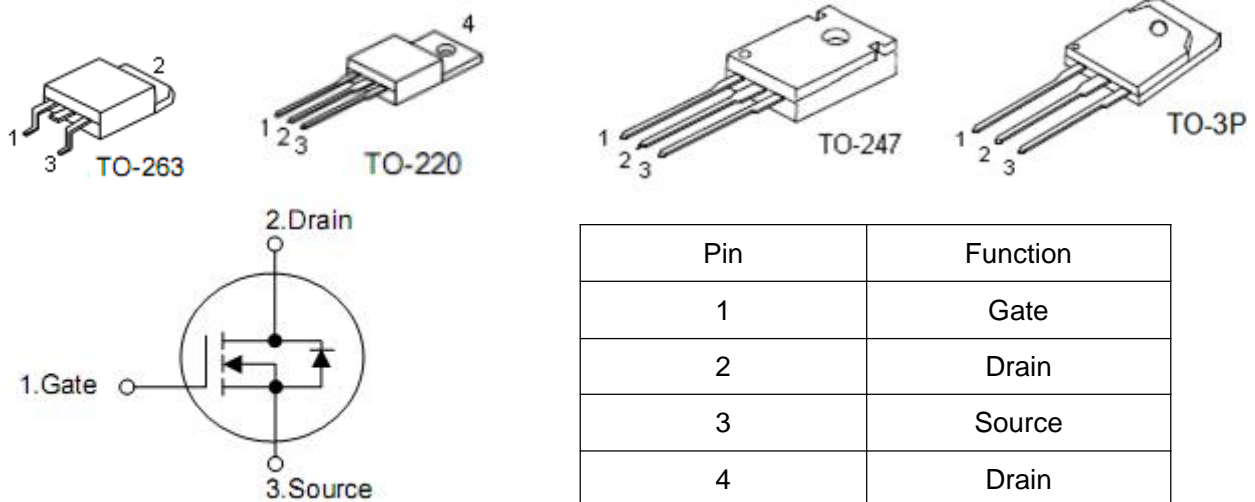

4. Absolute maximum ratings

($T_A=25^{\circ}\text{C}$, unless otherwise noted)

Parameter	Symbol	Rating		Units
		TO-220/ TO-263	TO-247/ TO-3P	
Drain-source voltage	V_{DSS}	80		V
Gate-source voltage	V_{GSS}	±25		V
Maximum junction temperature	T_J	175		°C
Storage temperature range	T_{STG}	-55 to 175		°C
Diode continuous forward current	I_S	150		A
Continuous drain current	I_D	150		A
	I_D	114		A
Pulse drain current*	I_{DM}	660**		A
Avalanche energy, single pulsed	E_{AS}	1.1***		J
Maximum power dissipation	P_D	178	214	W
	P_D	89	107	W

Note:* Repetitive rating; pulse width limited by junction temperature

** Drain current is limited by junction temperature

*** $V_D=64\text{V}$

5. Thermal characteristics

Parameter	Symbol	Rating	Unit
Thermal resistance, Junction-ambient	$R_{\theta JA}$	62.5	°C/W
Thermal resistance, Junction-case	$R_{\theta JC}$	0.7	°C/W

6. Electrical characteristics

($T_A=25^{\circ}\text{C}$, unless otherwise noted)

Parameter	Symbol	Test Conditions	Min	Typ	Max	Units
Drain-source breakdown voltage	BV_{DSS}	$V_{GS}=0V, I_{DS}=250\mu A$	80	-	-	V
Zero gate voltage drain current	I_{DSS}	$V_{DS}=80V, V_{GS}=0V$ $T_J=85^{\circ}\text{C}$	-	-	1	μA
			-	-	10	
Gate threshold voltage	$V_{GS(th)}$	$V_{DS}=V_{GS}, I_D=250\mu A$	2.0	3.0	4.0	V
Gate leakage current	I_{GSS}	$V_{GS}=\pm 25V, V_{DS}=0V$	-	-	± 100	nA
Drain-source on-state resistance	$R_{DS(on)^*}$	$V_{GS}=10V, I_D=85A$	-	4.0	4.5	$m\Omega$
Gate resistance	R_g	$V_{DS}=0V, V_{GS}=0V, f=1\text{MHz}$	-	1.8	-	Ω
Diode forward voltage	V_{SD}^*	$I_{SD}=85A, V_{GS}=0V$	-	0.8	1.2	V
Reverse recovery time	t_{rr}	$I_{SD}=85A,$ $di_{SD}/dt=100A/\mu s$	-	30	-	nS
Reverse recovery charge	Q_{rr}		-	52	-	nC
Input capacitance	C_{iss}	$V_{DS}=25V, V_{GS}=0V,$ $f=1\text{MHz}$	-	6109	-	μF
Output capacitance	C_{oss}		-	995	-	
Reverse transfer capacitance	C_{rss}		-	530	-	
Turn-on delay time	$t_{d(on)}$	$V_{DD}=40V, I_{DS}=85A,$ $R_G=6\Omega, V_{GS}=10V$	-	28	-	ns
Rise time	t_r		-	18	-	
Turn-off delay time	$t_{d(off)}$		-	42	-	
Fall time	t_f		-	54	-	
Total gate charge	Q_g	$V_{DS}=64V, V_{GS}=10V$ $I_{DS}=85A$	-	152	-	nC
Gate-source charge	Q_{gs}		-	25	--	
Gate-drain charge	Q_{gd}		-	53	--	

Note*: Pulse test; pulse width $\leq 300\mu s$ duty cycle $\leq 2\%$.

7. Test circuits and waveforms

Power Dissipation

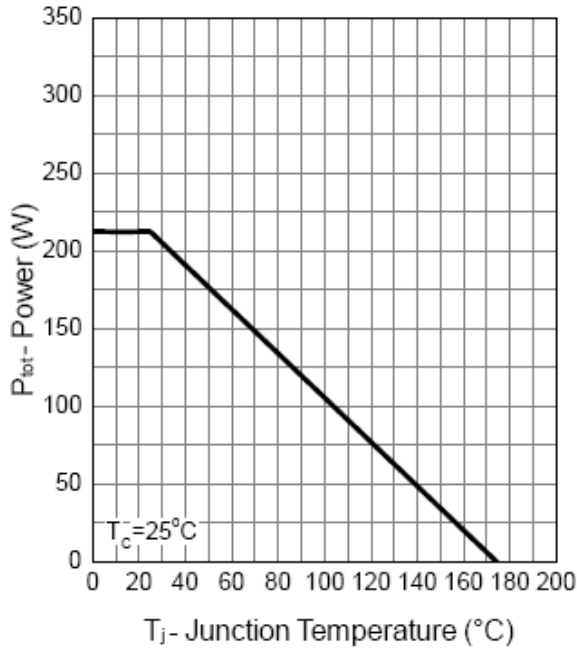

Drain Current

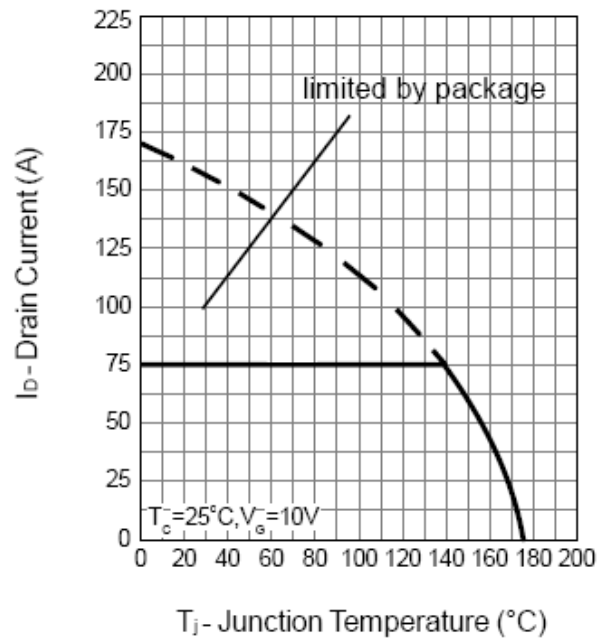

Safe Operation Area

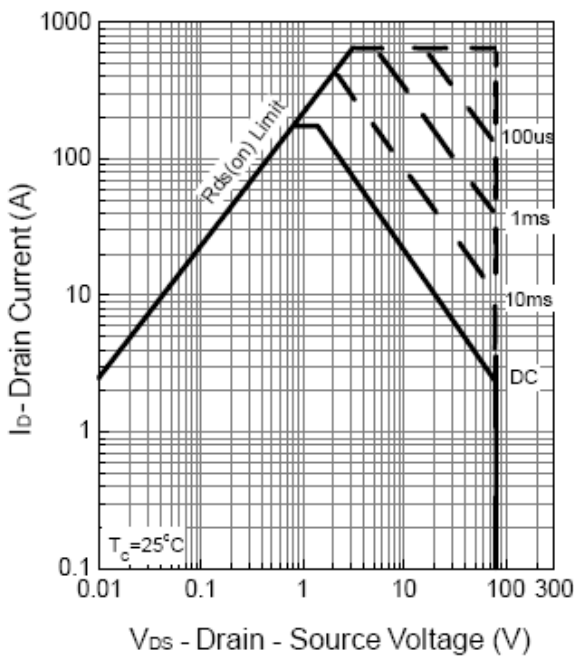

Thermal Transient Impedance

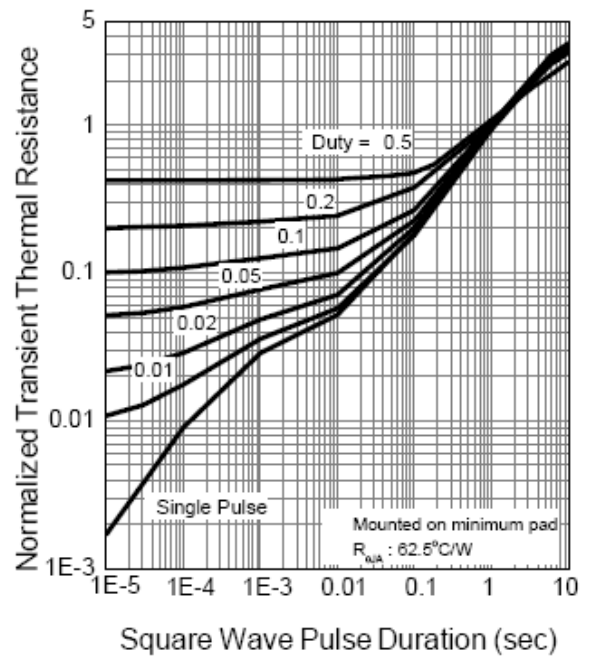

Output Characteristics

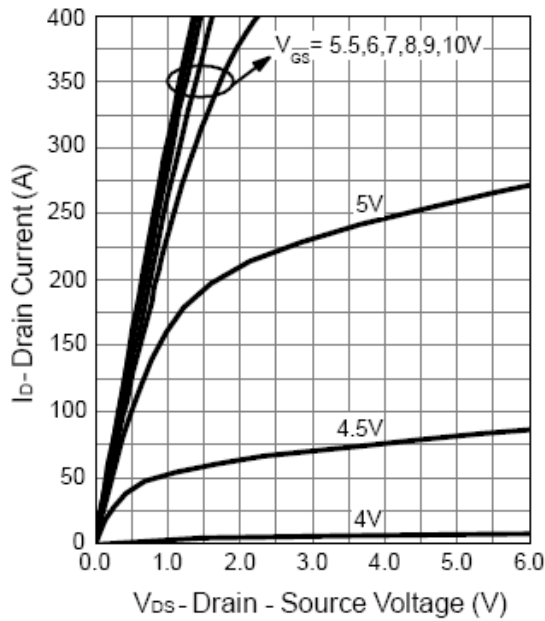

Drain-Source On Resistance

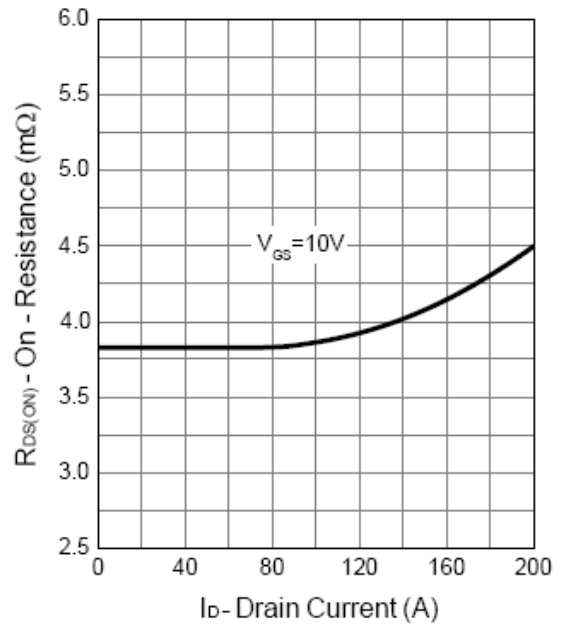

Gate-Source On Resistance

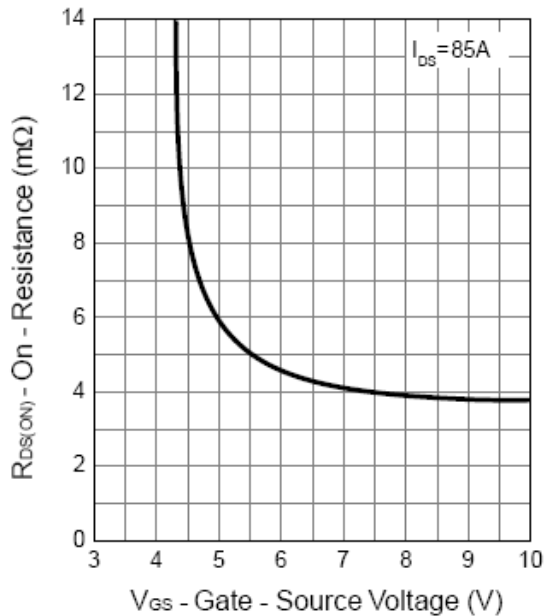

Gate Threshold Voltage

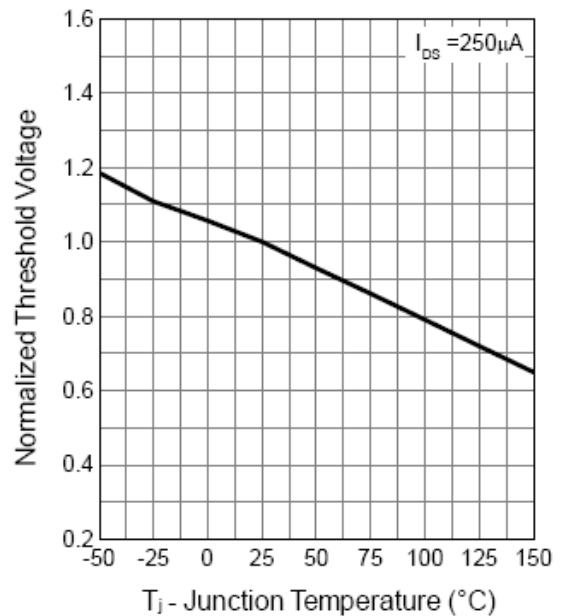

Drain-Source On Resistance

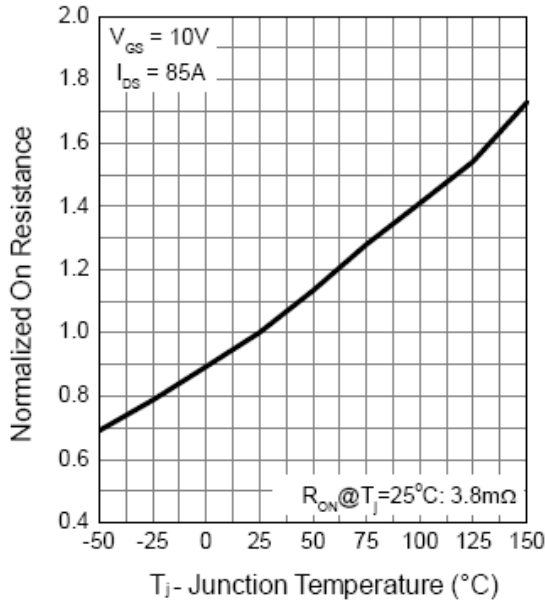

Source-Drain Diode Forward

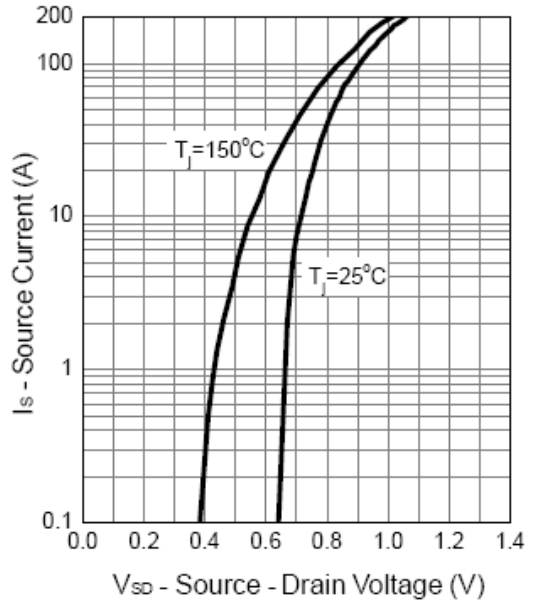

Capacitance

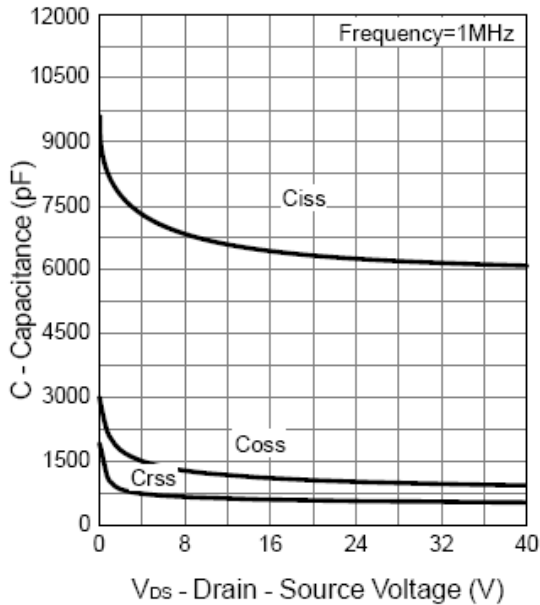

Gate Charge

