

为您的产品保驾护航

PRODUCT DATASHEET

PTC Devices · Surface Mount

JFC0402FS Series Fuse

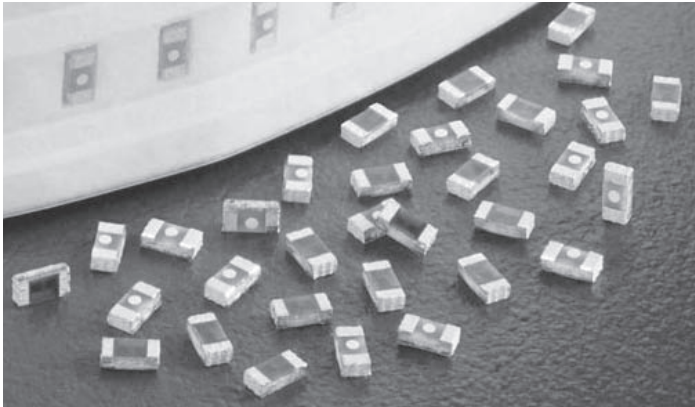



Description

The JFC0402FS Series are fast-acting surface mount thin-film fuses. Their ultra-small size (0402 size) makes them ideal for secondary protection of circuits used in space constrained applications such as hand-held portable electronic devices.

This series is 100% lead-free and meet the requirements of the RoHS directive. New Halogen-Free 497 Series fuses are available-to order use the " HF" suffix. See Part Numbering section for additional information.

Agency Approvals

Agency	Agency File Number	Ampere Range
	pending	0.250 - 5.0A
	pending	0.250 - 5.0A

Features

- 35A interrupt rating at 32VDC
- Small size with current ratings of 0.25 to 5.0 amperes
- RoHS compliant, lead-free and halogen-free
- Maximum protection of sensitive circuits as fuses are designed to open consistently in <5sec at 200% overload
- Enhanced Breaking Capacity, High I²t

Electrical Characteristics for Series

% of Ampere Rating	Opening Time at 25 C
100%	4 hours, Minimum
200%	5 sec., Maximum
300%	0.2 sec., Maximum

Applications

Secondary protection for space constrained applications such as:

- Cell phones
- Battery packs
- Digital cameras
- DVD players
- Hard disk drives

Electrical Specifications by Item

Part No.	Rated Current (A)	Max Voltage Rating (V)	Interrupting Rating	Nominal Cold Resistance (Ohms)	Nominal Melting I ² t (A ² sec)	Nom Voltage Drop (mV)	Nom Power (W)	Agency Approvals	
								UL US	SAFETY DEPARTMENT TYPE APPROVED
JFC0402-0250FS	0.250	32	35A @32V DC	0.400	0.0025	110.53	0.027635	×	×
JFC0402-0375FS	0.375	32		0.1930	0.0035	84.64	0.03174	×	×
JFC0402-0500FS	0.500	32		0.1600	0.0053	93.35	0.04668	×	×
JFC0402-0750FS	0.750	32		0.1050	0.0120	101.84	0.07638	×	×
JFC0402-1100FS	1	32		0.0730	0.0200	87.45	0.08745	×	×
JFC0402-1125FS	1.25	32		0.0600	0.0350	96.37	0.12046	×	×
JFC0402-1150FS	1.5	32		0.0470	0.0560	86.70	0.13005	×	×
JFC0402-1175FS	1.75	32		0.0390	0.0750	81.13	0.14198	×	×
JFC0402-1200FS	2	32		0.0300	0.1000	70.62	0.14120	×	×
JFC0402-1250FS	2.5	32		0.0185	0.1560	55.25	0.13813	×	×
JFC0402-1300FS	3	32		0.0165	0.2032	60.58	0.18740	×	×
JFC0402-1350FS	3.5	32		0.0135	0.3017	57.84	0.20244	×	×
JFC0402-1400FS	4	32		0.0115	0.3084	57.00	0.22800	×	×
JFC0402-1500FS	5	32		0.0085	0.5310	52.44	0.26220	×	×

1. Measured at 10% of rated current, 25 C.
2. Measured at rated voltage.

Temperature Derating Curve

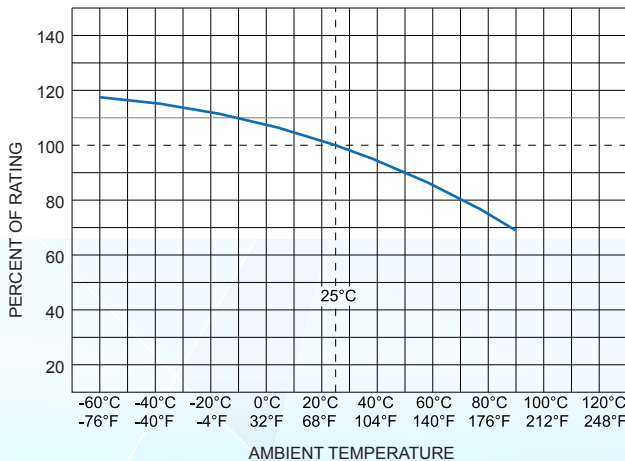

Note:
1. Derating depicted in this curve is in addition to the standard derating of 25 % for continuous operation.

Example:
For continuous operation at 70 degrees celsius, the fuse should be derated as follows:

$$I = (0.75)(0.80)I_{RAT} = (0.60)I_{RAT}$$

Average Time Current Curves

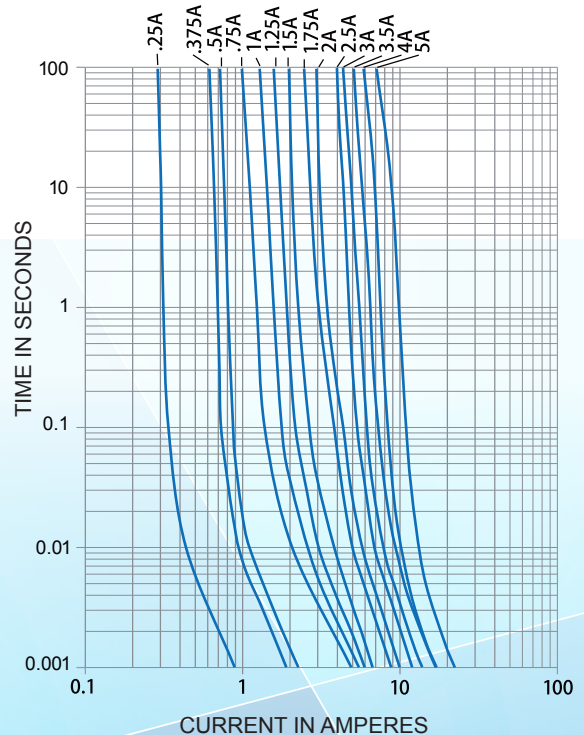

Soldering Parameters

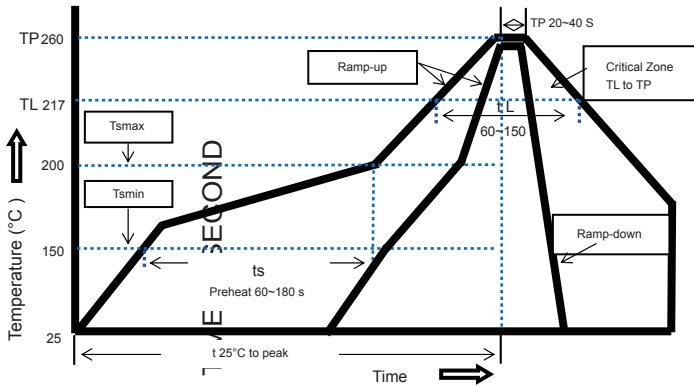

Reflow Condition

Pb-Free Assembly

Pre Heat

-Temperature Min(Ts min)	150 °C
-Temperature Max(Ts max)	200 °C
-Time(Min to Max)(ts)	60~120 seconds

Average ramp up rate

(Liquidus Temp (TL) to peak) 5 °C/second max

Ts(max) to TL- Ramp-up Rate

5 °C/second max

Reflow

-Temperature(TL) (Liquidus)	217 °C
-Temperature(TL)	60~150 seconds

Peak Temperature(Tp)

250^{+0/-5} °C

Time within 5 °C of actual

peak Temperature (Tp) 20-40 seconds

Ramp-Down Rate

5 °C/second max

Time 25 °C to Peak

Temperature (Tp) 8 minutes max.

Do not exceed

260 °C

Wave Soldering

260 °C, 10 seconds max.

Product Characteristics

Materials

Body: Epoxy/ Glass Substrate; Parts with 'HF' suffix: Halogen Free Epoxy / Glass
 Terminations: 100 % Tin over Nickel over Copper Device Weight: 0.316mg

Terminal Strength

MIL-STD-202 F ,Method 211A, Test Condition A

Insulation Resistance

After Opening: Greater than 10,000hms

Operating Temperature

-55 °C to 90 °C. Consult temperature derating curve chart .For operation above 90 °C please contact Littelfuse

Thermal Shock







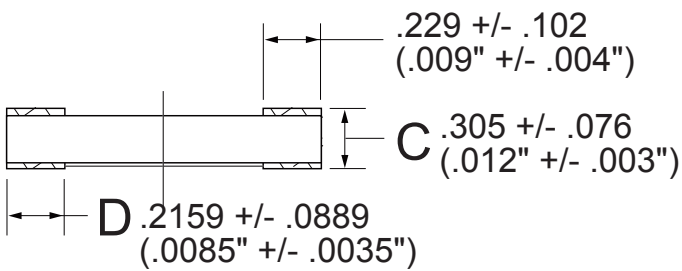
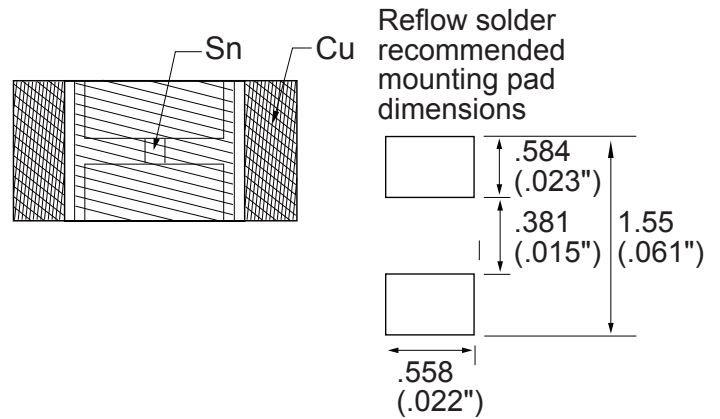
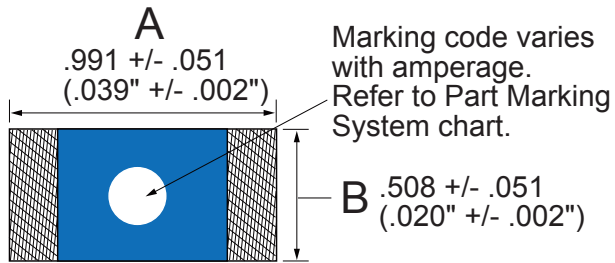







Withstands 5cycles of -55 °C to 125 °C

Vibration

MIL-STD-202 F

Dimensions

Part Marking System

	A	B	C	D
inch min	0.037	0.018	0.009	0.005
inch max	0.041	0.022	0.015	0.012
mm min	0.94	0.457	0.229	0.127
mm max	1.04	0.559	0.381	0.305

Amp Code	Marking Code
.250	
.375	
.500	
.750	
001.	
1.25	
01.5	
1.75	
002.	
02.5	
003.	
03.5	
004.	
005.	

Part Numbering System

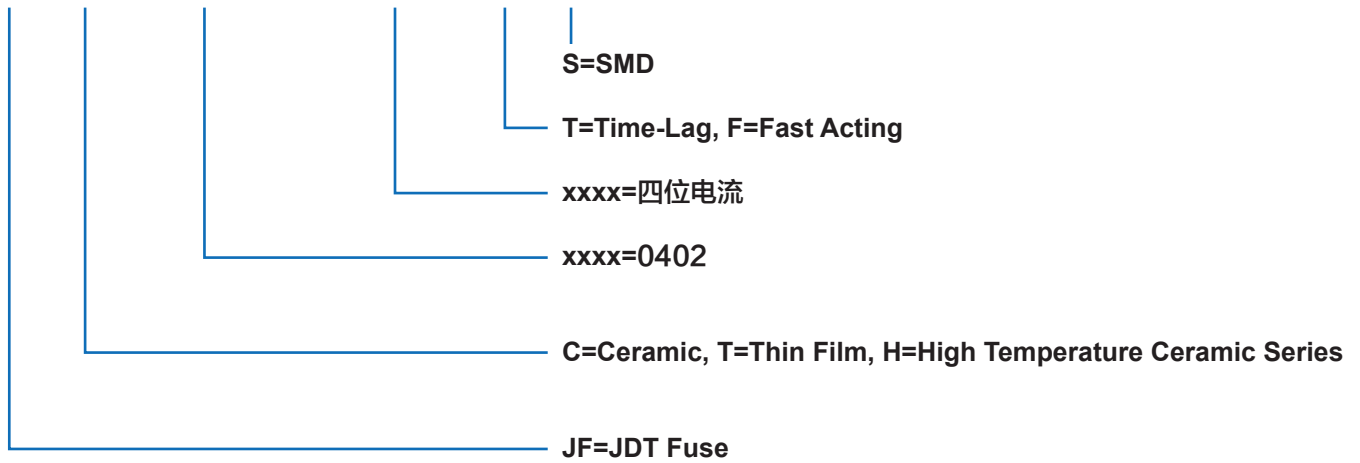
JF C 0402 - xxxx F S



Packaging

Packaging Option	Packaging Specification	Quantity	Quantity & Packaging Code
8mm Tape and Reel	EIA RS-481-2(IEC 286,part 3)	10000	