

Features

- Wide Input Voltage Range 4.5V to 52V
- 52V / 0.9Ω Internal Power MOSFET
- 600mA Peak Output Current
- Up to 90% Efficiency
- 1.25MHz (HT7463A) and 550kHz (HT7463B) Fixed Operating Frequency
- Ultra Low Shutdown Current < 1μA
- Output Short Circuit Protection
- Thermal Shutdown Protection
- Package Type: SOT23-6

Applications

- Power Meters
- Distribution Power Systems
- Battery Chargers
- Pre-Regulator for Linear Regulators

General Description

The HT7463A/B is a current mode buck converter. With a wide input range from 4.5V to 52V, the HT7463A/B is suitable for a wide range of applications such as power conditioning from unregulated sources. Having a low internal switch typical RDSON value of 0.9Ω, the device has a good operating typical efficiency value of 85% and the added advantage of reduced junction temperature. The operating frequency is fixed at 1250/550kHz for the HT7463A/HT7463B respectively. The HT7463A allows the use of small external components while still being able to have low output voltage ripple. A soft-start function can be implemented using the enable pin and by connecting an external RC circuit allowing the user to tailor the soft-start time to a specific application.

Application Circuit

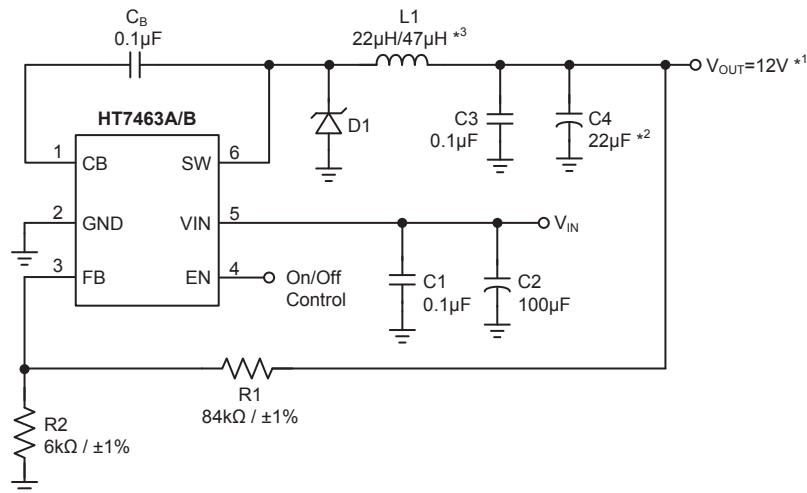

Note: *1. C4=330μF is recommended to achieve 1% output ripple requirement

*2. Set R1=84kΩ and R2=16kΩ for V_{OUT}=5V application

*3. It's recommended that L1=22μH for HT7463A and L1=47μH for HT7463B

Block Diagram

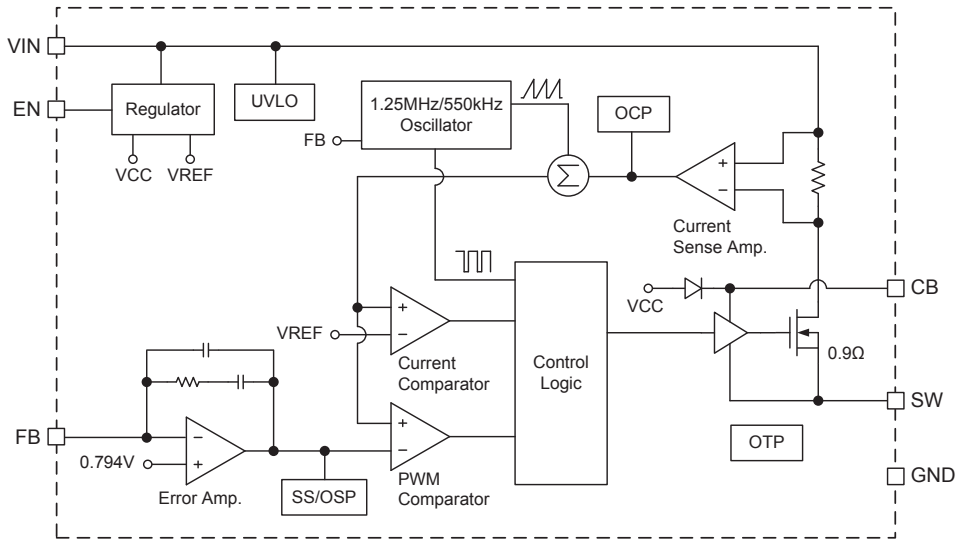

Pin Assignment

SOT23-6

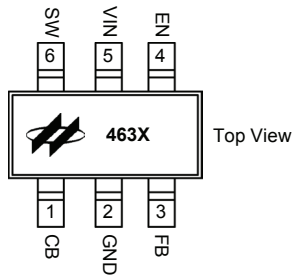

X means A(1.25MHz)/or B(550kHz)

Pin Description

Pin Order	Name	Type	Pin Discription
1	CB	I/O	SW FET gate bias voltage. Connect the boot capacitor between CB and SW
2	GND	G	Ground terminal
3	FB	I	Feedback pin: Set feedback voltage divider ratio with $V_{OUT} = V_{FB} (1+(R1/R2))$
4	EN	I	Logic level shutdown pin. Internal pull low resistor
5	VIN	P	Power supply
6	SW	O	Power FET output

Absolute Maximum Ratings

Parameter	Value	Unit
VIN and SW	-0.3 to +55	V
EN	-0.3 to ($V_{IN}+0.3$)	V
CB above SW voltage	+5.5	V
FB	-0.3 to +5.0	V
Operating Temperature Range	-40 to +85	°C
Maximum Junction Temperature	+150	°C
Storage Temperature Range	-65 to +160	°C
Lead Temperature (Soldering 10sec)	+300	°C
ESD Susceptibility	Human Body Model	2000
	Machine Model	200
Junction-to-Ambient Thermal Resistance, θ_{JA}	220	°C/W
Junction-to-Case Thermal Resistance, θ_{JC}	110	°C/W

Recommended Operating Range

Parameter	Value	Unit
VIN	4.5 to 52	V
SW and EN	Up to 52	V

Note that Absolute Maximum Ratings indicate limitations beyond which damage to the device may occur. Recommended Operating Ratings indicate conditions for which the device is intended to be functional, but do not guarantee specified performance limits.

Electrical Characteristics

 $V_{IN}=12V$ and $T_j=+25^{\circ}C$, unless otherwise specified

Symbol	Parameter	Test Condition	Min	Typ	Max	Unit
Supply Voltage						
V_{IN}	Input Voltage	V_{IN}	4.5	—	52	V
I_{CC}	Quiescent Current	$V_{EN}=2.5V, V_{FB}=1V$	—	0.7	1	mA
I_{OFF}	Shutdown Current	$V_{EN}=0V$	—	0.1	1	μA
Buck Converter						
V_{OUT}	Output Voltage*	—	1.0	—	$0.9 \times V_{IN}$	V
f_{SW}	Switching Frequency	HT7463A, $V_{FB}=0.6V$	1000	1250	1500	kHz
		HT7463B, $V_{FB}=0.6V$	440	550	660	kHz
F_{FB}	Fold-back Frequency	HT7463A, $V_{FB}=0V$	90	105	—	kHz
		HT7463B, $V_{FB}=0V$	90	105	—	kHz
D_{MAX}	Maximum Duty Cycle	HT7463A	—	90	—	%
		HT7463B	—	95	—	%
$T_{ON(min)}$	Minimum ON-Time	—	—	100	—	ns
$R_{DS(on)}$	Switch-ON Resistance	$V_{EN}=2.5V$	—	0.9	—	Ω
$I_{SW(off)}$	SW Leakage Current	$V_{EN}=0V, V_{SW}=0V, V_{IN}=52V$	—	0.1	1	μA
V_{FB}	Feedback Voltage	$4.5V \leq V_{IN} \leq 52V$	0.778	0.794	0.81	V
$I_{FB(leak)}$	Feedback Leakage Current	$V_{FB}=3V$	—	—	0.1	μA
I_{EN}	EN Input Current	$V_{EN}=0V$	—	0.1	—	μA
		$V_{EN}=52V$	—	16	—	μA
V_{IH}	EN High Voltage Threshold	$4.5V \leq V_{IN} \leq 52V$	2.3	—	—	V
V_{IL}	EN Low Voltage Threshold	$4.5V \leq V_{IN} \leq 52V$	—	—	0.9	V
Protections						
V_{UVLO+}	Input Supply Turn ON Level	UVLO+	—	—	4.2	V
V_{UVLO-}	Input Supply Turn OFF Level	UVLO-	3.4	—	—	V
I_{OCP}	Over Current Protection Threshold	—	—	1	—	A
T_{SHD}	Thermal Shutdown Threshold	OTP	—	150	—	$^{\circ}C$
T_{REC}	Thermal Recovery Temperature	—	—	125	—	$^{\circ}C$

Note: 1. MIN Output Voltage is restricted by Minimum ON-Time, 100ns.

2. MAX Output Voltage is restricted by Maximum Duty Cycle and Switch-ON Resistance.

Typical Performance Characteristics

$V_{IN}=18V$, $V_{OUT}=12.5V$, $L=15/22\mu H$ for HT7463A and $L=33/47\mu H$ for HT7463B, $T_A=25^\circ C$, unless otherwise noted

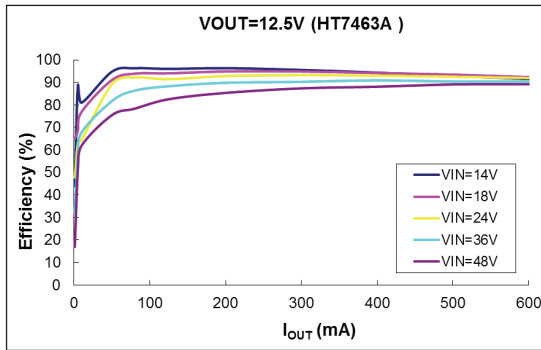

Efficiency vs. Load (HT7463A, $V_{OUT}=12.5V$)

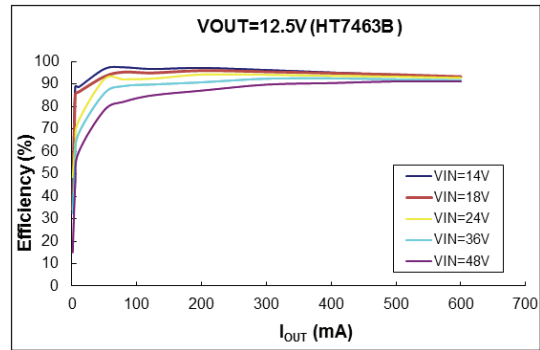

Efficiency vs. Load (HT7463B, $V_{OUT}=12.5V$)

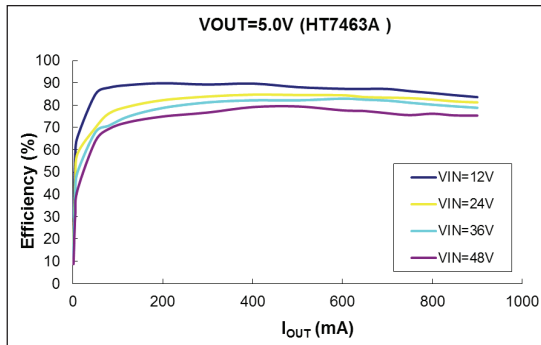

Efficiency vs. Load (HT7463A, $V_{OUT}=5.7V$)

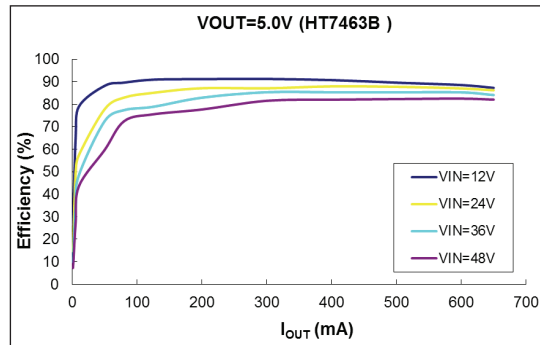

Efficiency vs. Load (HT7463B, $V_{OUT}=5.7V$)

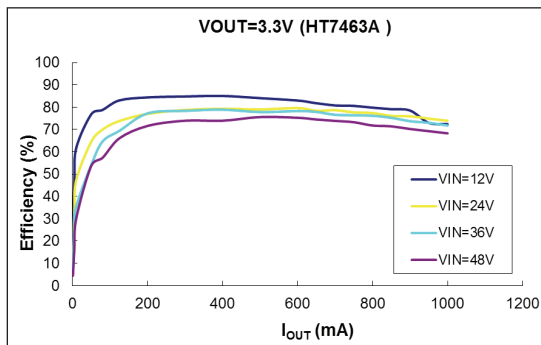

Efficiency vs. Load (HT7463A, $V_{OUT}=3.3V$)

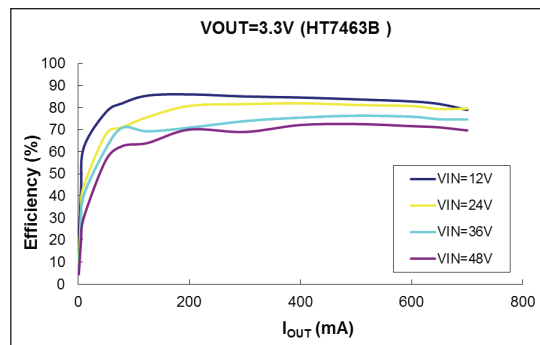

Efficiency vs. Load (HT7463B, $V_{OUT}=3.3V$)

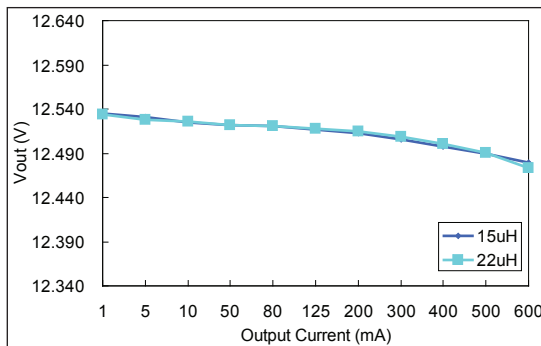

Load Regulation (HT7463A, $V_{OUT}=12.5V$)

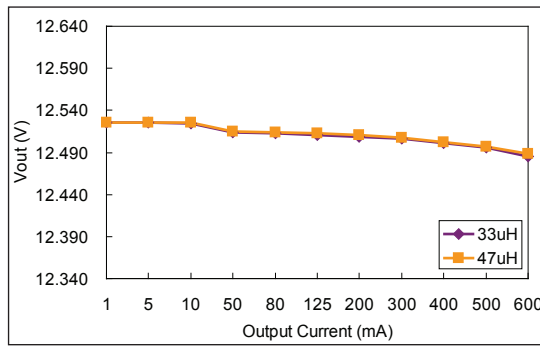

Load Regulation (HT7463B, $V_{OUT}=12.5V$)

Typical Performance Characteristics (Continued)

$V_{IN}=18V$, $V_{OUT}=12.5V$, $L=22\mu H$ for HT7463A and $L=47\mu H$ for HT7463B, $T_A=25^\circ C$, unless otherwise noted

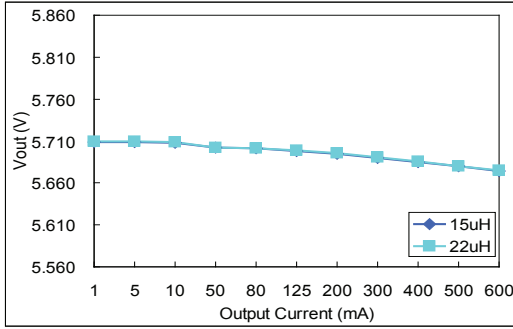

Load Regulation (HT7463A, $V_{OUT}=5.7V$)

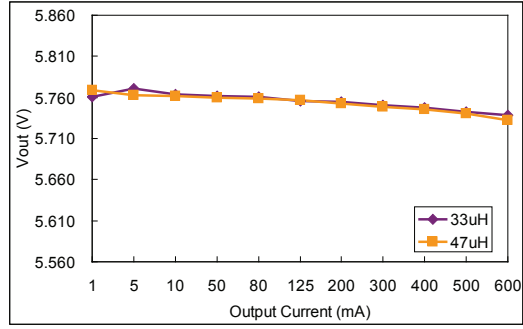

Load Regulation (HT7463B, $V_{OUT}=5.7V$)

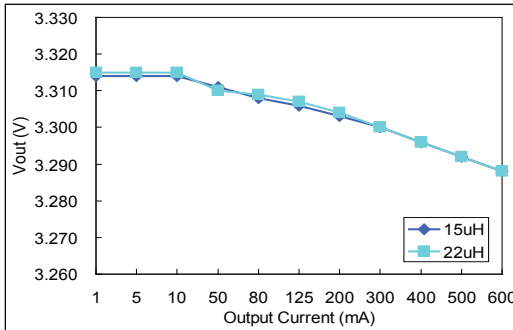

Load Regulation (HT7463A, $V_{OUT}=3.3V$)

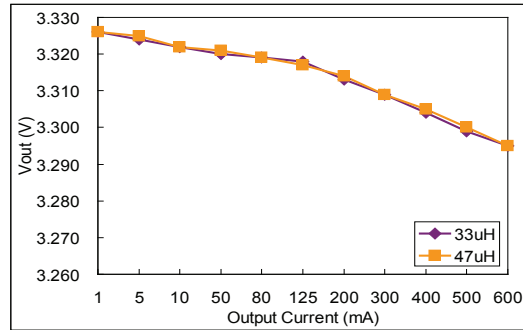

Load Regulation (HT7463B, $V_{OUT}=3.3V$)

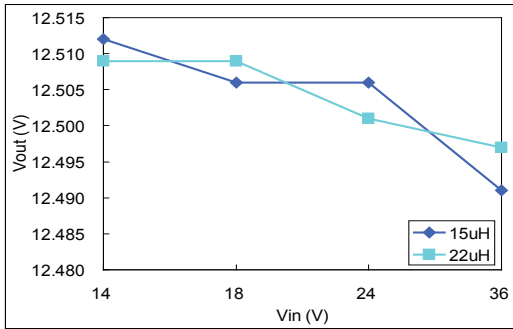

Line Regulation (HT7463A, $V_{OUT}=12.5V$, $I_{OUT}=300mA$)

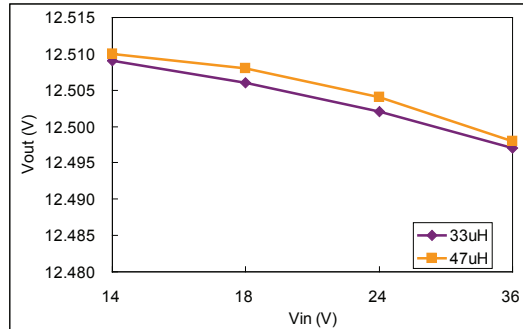

Line Regulation (HT7463B, $V_{OUT}=12.5V$, $I_{OUT}=300mA$)

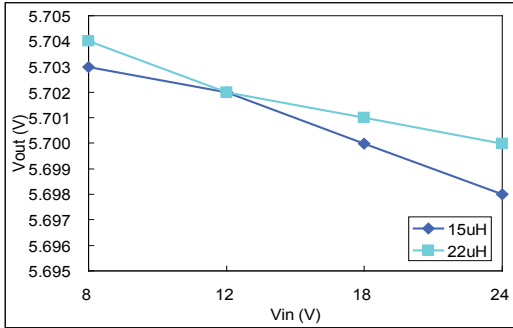

Line Regulation (HT7463A, $V_{OUT}=5.7V$, $I_{OUT}=300mA$)

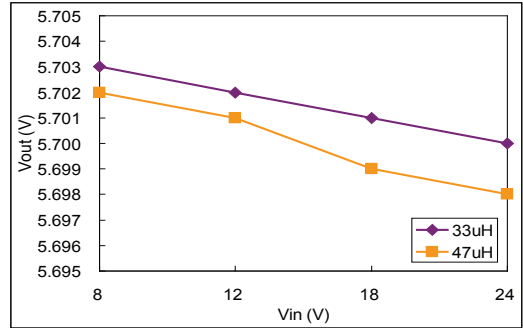

Line Regulation (HT7463B, $V_{OUT}=5.7V$, $I_{OUT}=300mA$)

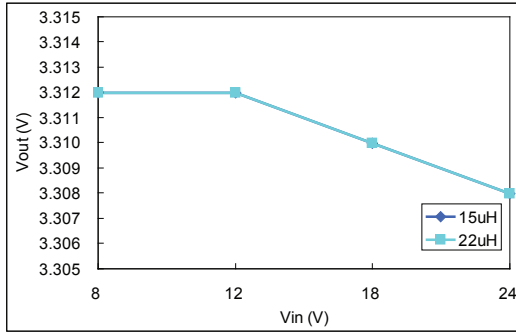

Line Regulation (HT7463A, V_{OUT}=3.3V, I_{OUT}=300mA)

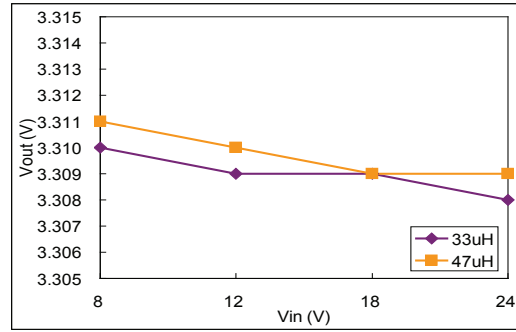

Line Regulation (HT7463B, V_{OUT}=3.3V, I_{OUT}=300mA)

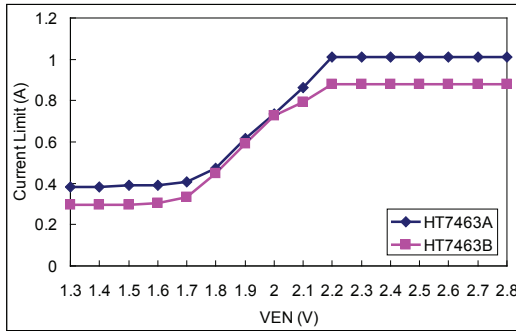

IOCP vs. VEN (HT7463A and HT7463B)

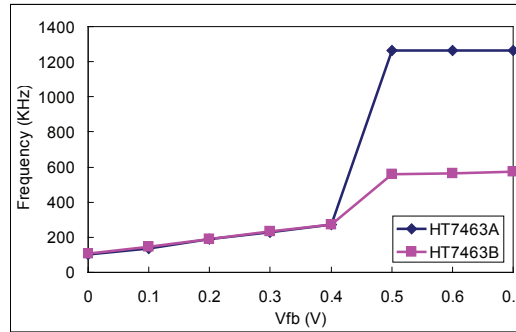

f_{sw} vs. VFB (HT7463A and HT7463B)

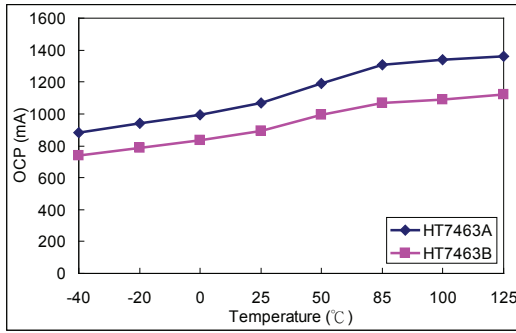

IOCP vs. TEMP (HT7463A and HT7463B)

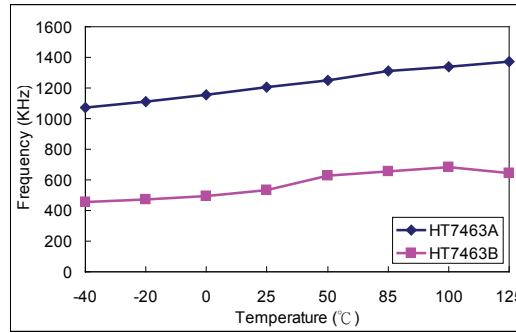

f_{sw} vs. TEMP (HT7463A and HT7463B)

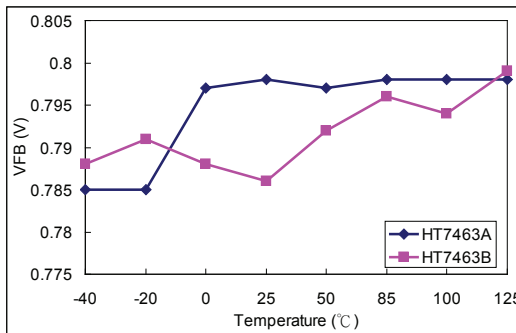

VFB vs. TEMP (HT7463A and HT7463B)

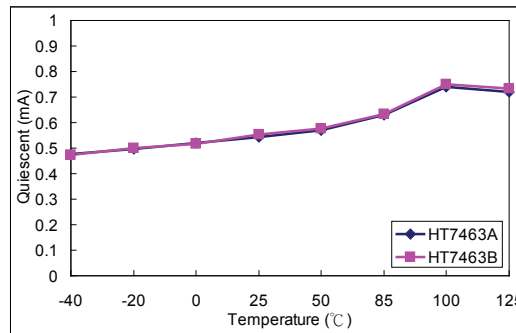

ICC vs. TEMP (HT7463A and HT7463B)

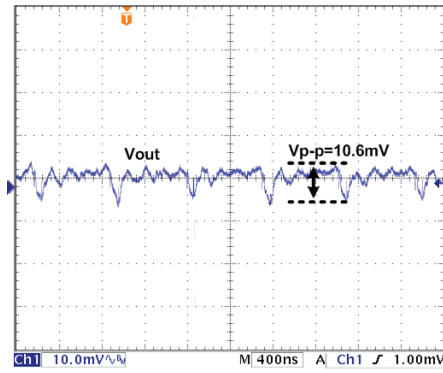

Output Ripple (HT7463A, $I_{OUT}=400mA$)

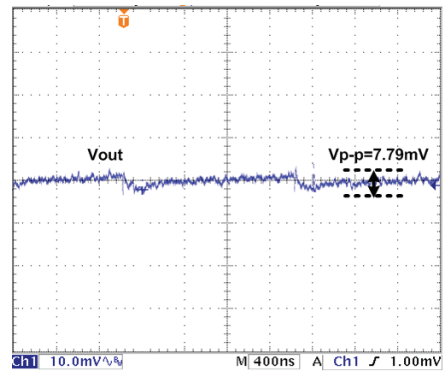

Output Ripple (HT7463B, $I_{OUT}=400mA$)

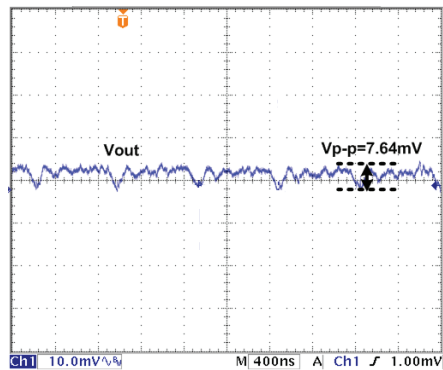

Output Ripple (HT7463A, $I_{OUT}=125mA$)

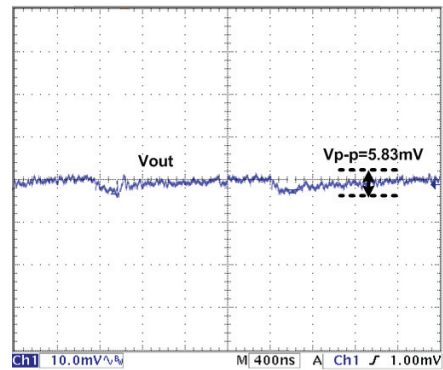

Output Ripple (HT7463B, $I_{OUT}=125mA$)

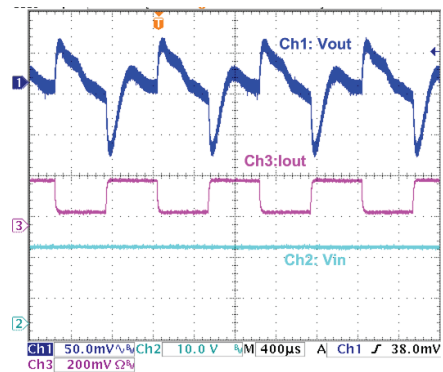

Load Transient (HT7463A, $I_{OUT}=50mA$ to $200mA$)

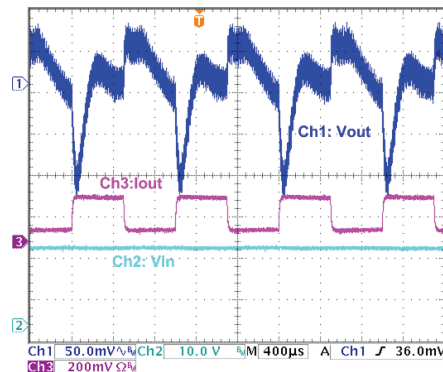

Load Transient (HT7463B, $I_{OUT}=50mA$ to $200mA$)

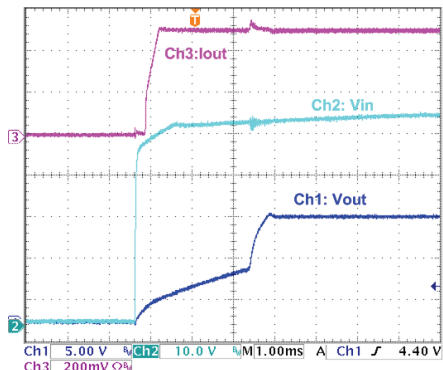

Power Up (HT7463A, $V_{IN}=52V$, $I_{OUT}=500mA$)

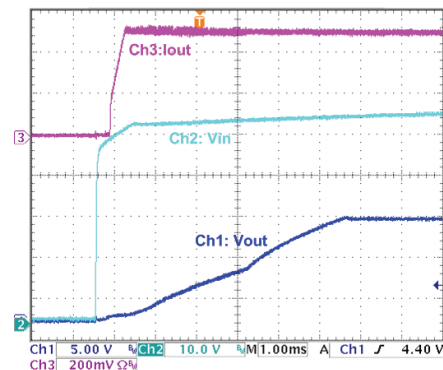

Power Up (HT7463B, $V_{IN}=52V$, $I_{OUT}=500mA$)

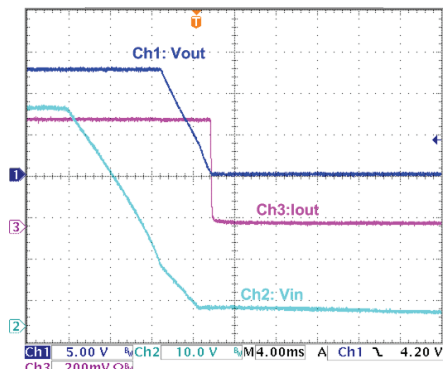

Power Down (HT7463A, $V_{IN}=52V$, $I_{OUT}=500mA$)

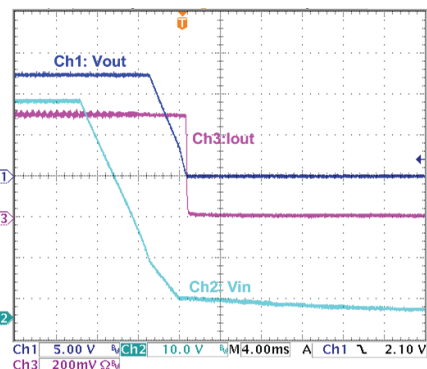

Power Down (HT7463B, $V_{IN}=52V$, $I_{OUT}=500mA$)

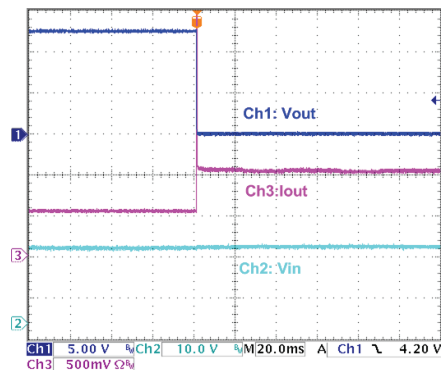

Output Short (HT7463A, $I_{OUT}=500mA$)

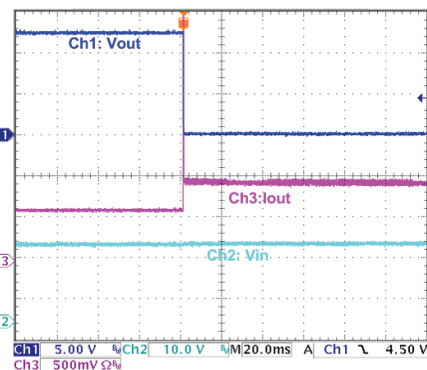

Output Short (HT7463B, $I_{OUT}=500mA$)

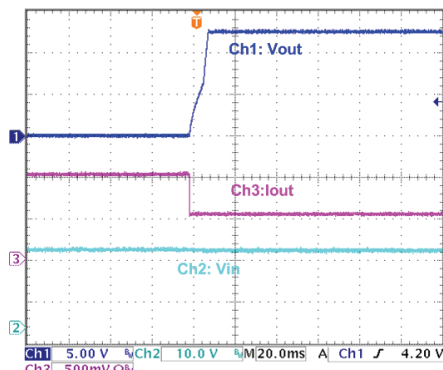

Short Recovery (HT7463A, $I_{OUT}=500mA$)

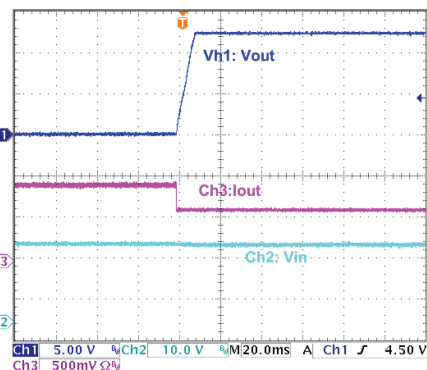

Short Recovery (HT7463B, $I_{OUT}=500mA$)

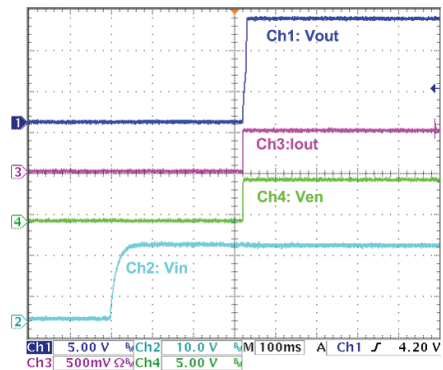

Enable ON (HT7463A, $I_{OUT}=500mA$)

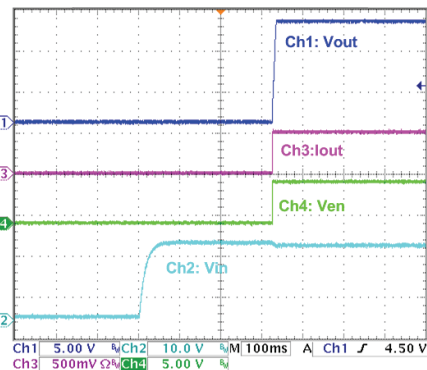

Enable ON (HT7463B, $I_{OUT}=500mA$)

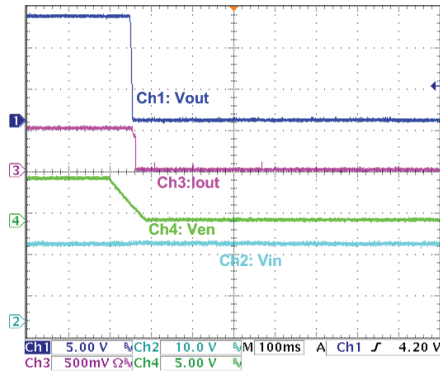
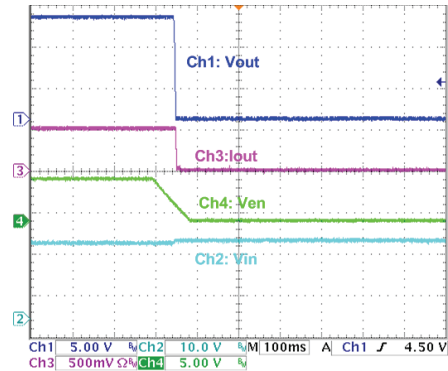
Enable OFF (HT7463A, I_{OUT}=500mA)

Enable OFF (HT7463B, I_{OUT}=500mA)

Functional Description

Output Voltage Setup

The external resistor divider sets the output voltage, for details see the Application Circuit. The feedback resistor, R1, also sets the feedback loop bandwidth with the internal compensation capacitor. R2 is calculated using the following equation:

$$R2 = R1 / ((V_{OUT} / 0.794V) - 1) \Omega$$

Protection Features

The devices include dedicated protection circuitry which is fully active during normal operation for full device protection. The thermal shutdown circuitry turns off power to the device when the die temperature reaches excessive levels. The UVLO comparator protects the power device during supply power startup and shutdown to prevent operation at voltages less than the minimum input voltage. The HT7463A/B also features a shutdown mode decreasing the supply current to approximately 0.1μA.

Recommended Component Values

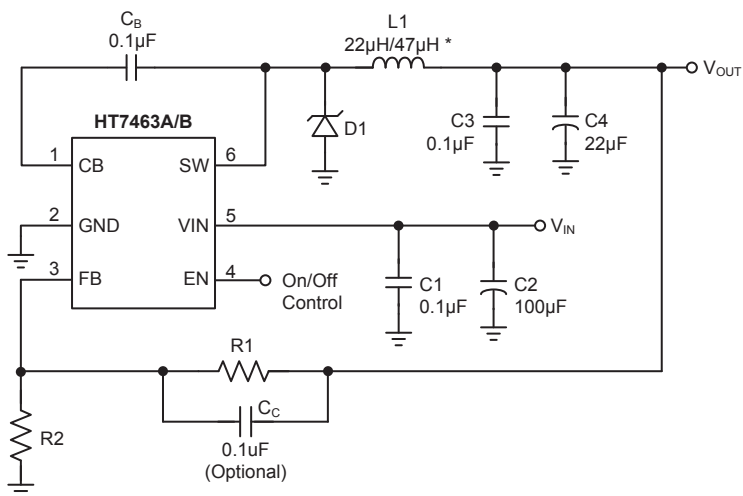

Note: * It's recommended that L1=22µH for HT7463A and L1=47µH for HT7463B.

V _{out} (V)	R1 (kΩ)	R2 (kΩ)
3.3	51 (1%)	16 (1%)
5.0	82 (1%)	15 (1%)
12.5	91 (1%)	6.2 (1%)

Frequency Fold-back Function

The devices include a frequency fold-back function to prevent situations of over current when the output is shorted. It efficiently reduces overheating even if the output is shorted. This function is implemented by changing the switching frequency according to the feedback voltage, V_{FB} . When the output node is shorted, the device will reduce the frequency to 105kHz for the HT7463A/HT7463B respectively resulting in a clamped input current. The HT7463A/HT7463B operates at a frequency of 1250/550kHz under normal conditions and the feedback voltage is about 0.794V.

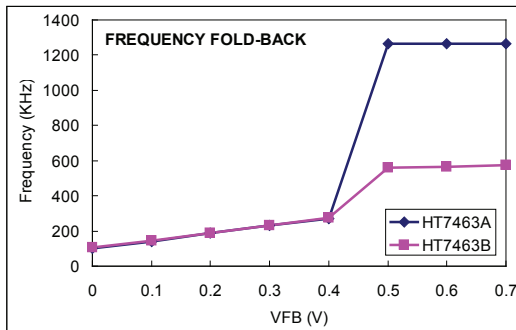

Start-up Function

The device EN pin in conjunction with an RC filter is used to tailor the soft-start time to specific application requirements. When a voltage applied to the EN pin is between 0V and 2.3V, the device will cause the cycle-by-cycle current limit in the power stage to be modulated for a minimum current limit at 0V up to a the rated current limit at 2.3V. Thus, the output rise time and inrush current at startup are controlled.

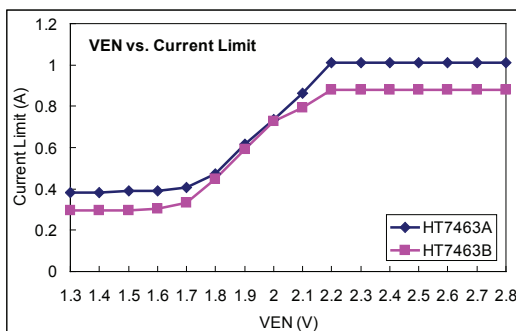

Component Selection Guide

Inductor

Use an inductor with a DC current rating at least 25% percent higher than the maximum load current for most applications. The DC resistance of the inductor is a key parameter affecting efficiency. With regard to efficiency, the inductor's DC resistance should be less than 200mΩ. For most application, the inductor value can be calculated from the following equation.

$$L = \frac{V_{out} \times (V_{IN} - V_{out})}{V_{IN} \times I_{ripple} \times f_{sw}}$$

A higher value of ripple current reduces the inductance value, but increases the conduction loss, core loss, and current stress for the inductor and switch devices. A suggested choice is for the inductor ripple current to be 30% of the maximum load current.

Input Capacitor

A low ESR ceramic capacitor (CIN) is needed between the VIN pin and GND pin. Use ceramic capacitors with X5R or X7R dielectrics for their low ESRs and small temperature coefficients. For most applications, a 2.2μF- 10μF capacitor will suffice.

Output Capacitor

The selection of COUT is driven by the maximum allowable output voltage ripple. Use ceramic capacitors with X5R or X7R dielectrics for their low ESR characteristics. Capacitors in the range of 22μF to 100μF are a good starting point with an ESR of 0.1Ω or less.

Schottky Diode

The breakdown voltage rating of the diode should be higher than the maximum input voltage. The current rating for the diode should be equal to the maximum output current to ensure the best reliability in most applications. In this case it is possible to use a diode with a lower average current rating, however the peak current rating should be higher than the maximum load current.

Bootstrap Capacitor

A 0.1μF ceramic capacitor or larger is recommended for the bootstrap capacitor. Generally a 0.1μF to 1μF value can be used to ensure sufficient gate drive for the internal switches and a consistently low $R_{DS(on)}$.

Layout Consideration Guide

To reduce problems with conducted noise, there are some important points to consider regarding the PCB layout.

- Ensure all feedback connections are short and direct. Place the feedback resistors and compensation components as close to the FB pin as possible.
- The input bypass capacitor must be placed close to the VIN pin.
- The inductor, schottky diode and output capacitor trace should be as short as possible to reduce conducted and radiated noise and increase overall efficiency.
- Keep the power ground connection as short and wide as possible.

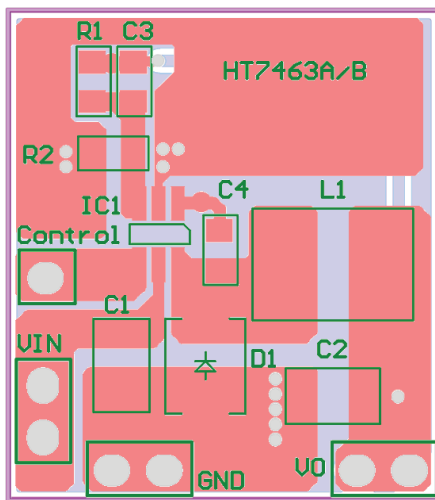

Thermal Considerations

The maximum power dissipation depends on the thermal resistance of the IC package, the PCB layout, the rate of the surrounding airflow and the difference between the junction and ambient temperature. The maximum power dissipation can be calculated by the following formula:

$$P_{D(MAX)} = (T_{J(MAX)} - T_A) / \theta_{JA}$$

where $T_{J(MAX)}$ is the maximum junction temperature, T_A is the ambient temperature and θ_{JA} is the junction-to-ambient thermal resistance of the IC package (220°C/W for SOT23-6)

For maximum operating rating conditions, the maximum junction temperature is 150°C. However, it is recommended that the maximum junction temperature does not exceed 125°C in normal operation to maintain reliability. The derating curve for maximum power dissipation is as follows:

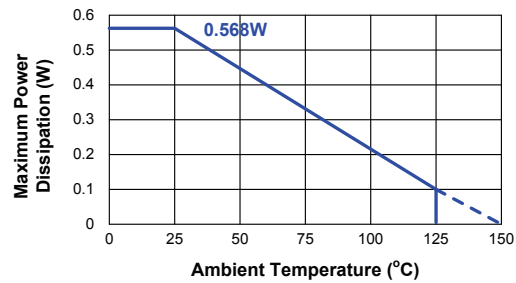

Package Information

Note that the package information provided here is for consultation purposes only. As this information may be updated at regular intervals users are reminded to consult the [Holtek website](#) for the latest version of the [Package/ Carton Information](#).

Additional supplementary information with regard to packaging is listed below. Click on the relevant section to be transferred to the relevant website page.

- Package Information (include Outline Dimensions, Product Tape and Reel Specifications)
- The Operation Instruction of Packing Materials
- Carton information

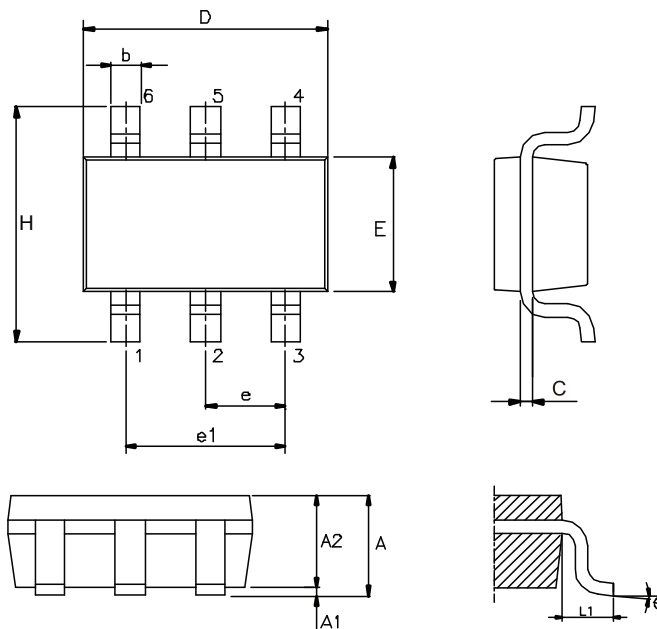
SOT23-6 Outline Dimensions

Symbol	Dimensions in inch		
	Min.	Nom.	Max.
A	—	—	0.057
A1	—	—	0.006
A2	0.035	0.045	0.051
b	0.012	—	0.020
C	0.003	—	0.009
D	—	0.114 BSC	—
E	—	0.063 BSC	—
e	—	0.037 BSC	—
e1	—	0.075 BSC	—
H	—	0.110 BSC	—
L1	—	0.024 BSC	—
θ	0°	—	8°

Symbol	Dimensions in mm		
	Min.	Nom.	Max.
A	—	—	1.45
A1	—	—	0.15
A2	0.90	1.15	1.30
b	0.30	—	0.50
C	0.08	—	0.22
D	—	2.90 BSC	—
E	—	1.60 BSC	—
e	—	0.95 BSC	—
e1	—	1.90 BSC	—
H	—	2.80 BSC	—
L1	—	0.60 BSC	—
θ	0°	—	8°

Copyright© 2017 by HOLTEK SEMICONDUCTOR INC.

The information appearing in this Data Sheet is believed to be accurate at the time of publication. However, Holtek assumes no responsibility arising from the use of the specifications described. The applications mentioned herein are used solely for the purpose of illustration and Holtek makes no warranty or representation that such applications will be suitable without further modification, nor recommends the use of its products for application that may present a risk to human life due to malfunction or otherwise. Holtek's products are not authorized for use as critical components in life support devices or systems. Holtek reserves the right to alter its products without prior notification. For the most up-to-date information, please visit our web site at <http://www.holtek.com.tw>.