

TO-220-3L Plastic-Encapsulate Voltage Regulators

CJ7905 Three-terminal negative voltage regulator

FEATURES

- Maximum output current
 $I_{OM}: 1.5\text{ A}$
- Output voltage
 $V_O: -5\text{ V}$
- Continuous total dissipation
 $P_D: 1.5\text{ W}$ ($T_a = 25\text{ }^\circ\text{C}$)

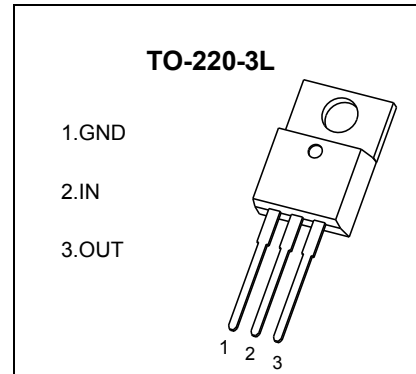

ABSOLUTE MAXIMUM RATINGS (Operating temperature range applies unless otherwise specified)

Parameter	Symbol	Value	Unit
Input Voltage	V_i	-35	V
Thermal Resistance from Junction to Air	$R_{\theta JA}$	83.3	$^\circ\text{C/W}$
Operating Junction Temperature Range	T_{OPR}	0~+150	$^\circ\text{C}$
Storage Temperature Range	T_{STG}	-65~+150	$^\circ\text{C}$

ELECTRICAL CHARACTERISTICS AT SPECIFIED VIRTUAL JUNCTION TEMPERATURE ($V_i = -10\text{ V}, I_o = 500\text{ mA}, C_i = 2.2\text{ }\mu\text{F}, C_o = 1\text{ }\mu\text{F}$, unless otherwise specified)

Parameter	Symbol	Test conditions	Min	Typ	Max	Unit
Output Voltage	V_o	$25\text{ }^\circ\text{C}$	-4.8	-5	-5.2	V
		$-7\text{ V} \leq V_i \leq -20\text{ V}, I_o = 5\text{ mA} - 1\text{ A}$	0-125 $^\circ\text{C}$	-4.75	-5	-5.25
Load Regulation	ΔV_o	$I_o = 5\text{ mA} - 1.5\text{ A}$	$25\text{ }^\circ\text{C}$	15	100	mV
		$I_o = 250\text{ mA} - 750\text{ mA}$	$25\text{ }^\circ\text{C}$	5	50	mV
Line Regulation	ΔV_o	$-7\text{ V} \leq V_i \leq -25\text{ V}$	$25\text{ }^\circ\text{C}$	12.5	50	mV
		$-8\text{ V} \leq V_i \leq -12\text{ V}$	$25\text{ }^\circ\text{C}$	4	15	mV
Quiescent Current	I_q	$25\text{ }^\circ\text{C}$		1.5	2	mA
Quiescent Current Change	ΔI_q	$-7\text{ V} \leq V_i \leq -25\text{ V}$	0-125 $^\circ\text{C}$		0.5	mA
	ΔI_q	$5\text{ mA} \leq I_o \leq 1\text{ A}$	0-125 $^\circ\text{C}$		0.5	mA
Output Noise Voltage	V_N	$10\text{ Hz} \leq f \leq 100\text{ KHz}$	$25\text{ }^\circ\text{C}$	125		$\mu\text{V}/V_o$
Output Voltage Drift	$\Delta V_o / \Delta T$	$I_o = 5\text{ mA}$	0-125 $^\circ\text{C}$	-0.4		$\text{mV}/^\circ\text{C}$
Ripple Rejection	RR	$-8\text{ V} \leq V_i \leq -18\text{ V}, f = 120\text{ Hz}$	0-125 $^\circ\text{C}$	54	60	dB
Dropout Voltage	V_d	$I_o = 1\text{ A}$	$25\text{ }^\circ\text{C}$	1.1		V
Peak Current	I_{pk}	$25\text{ }^\circ\text{C}$		2.1		A

* Pulse test.

TYPICAL APPLICATION

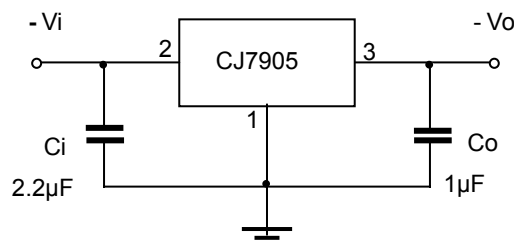

Typical Characteristics

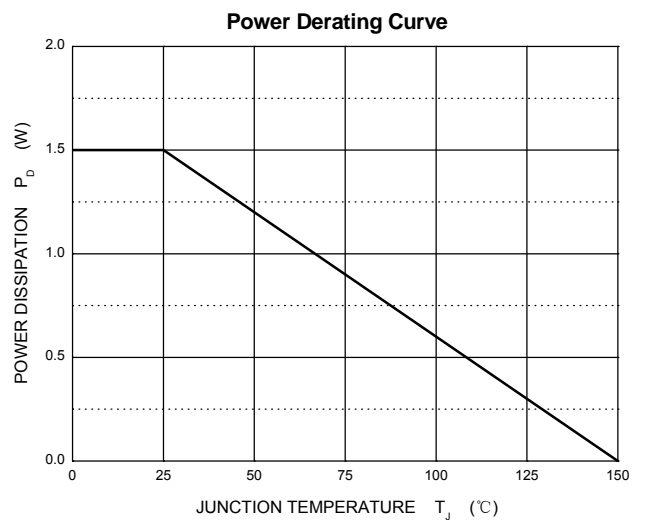
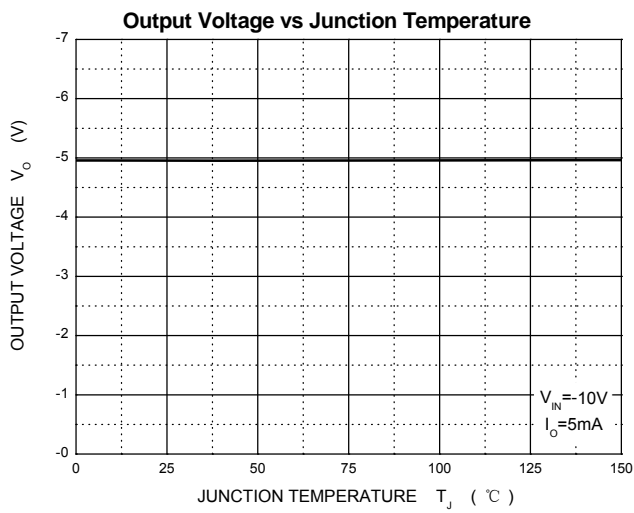
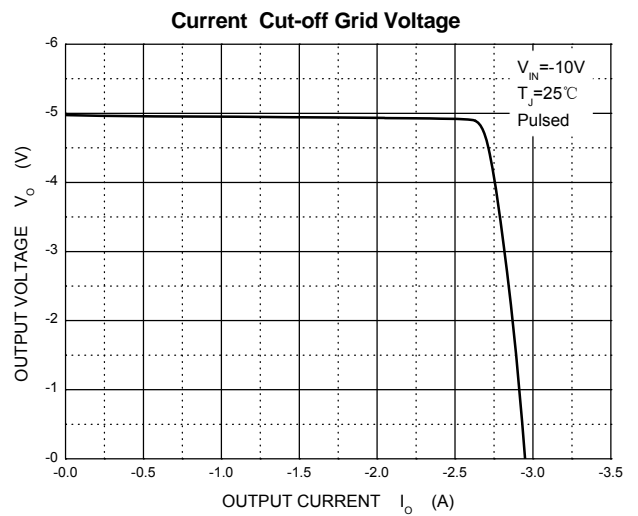
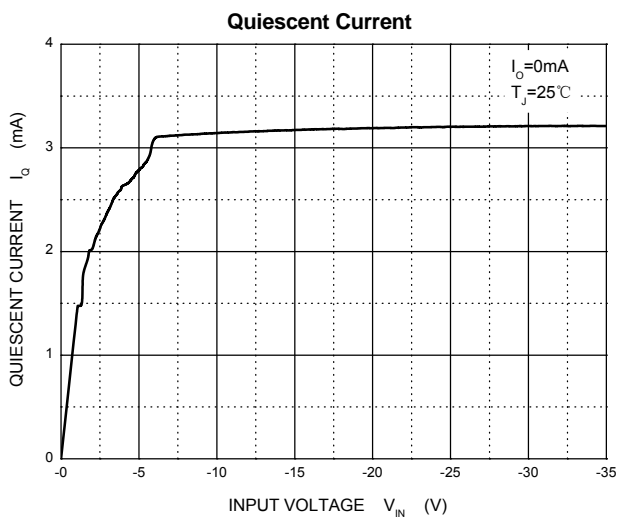
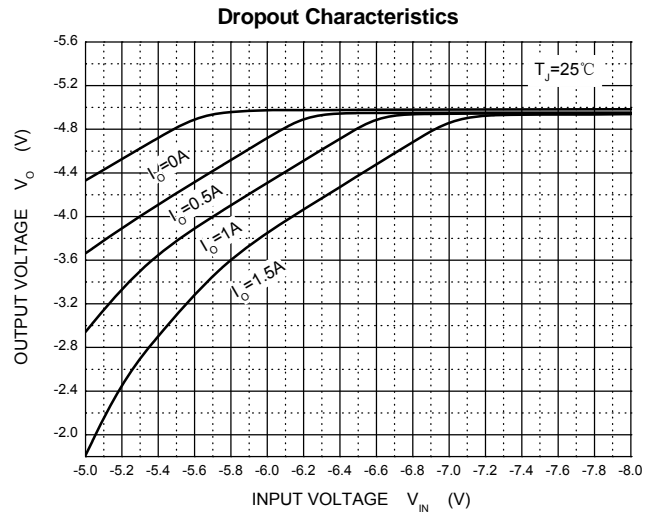
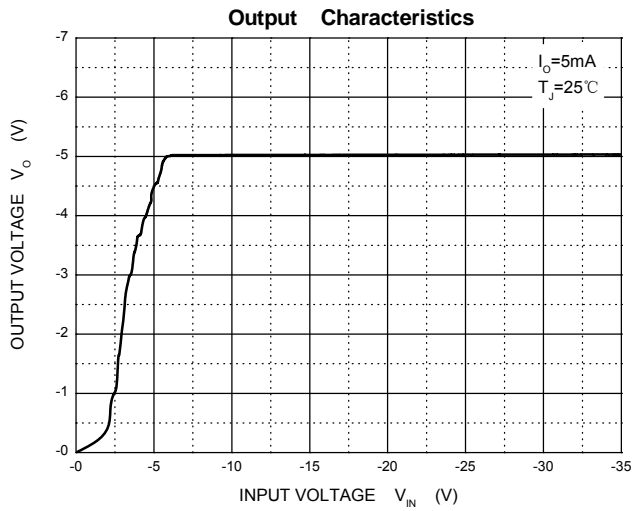

TO-220-3L Package Outline Dimensions

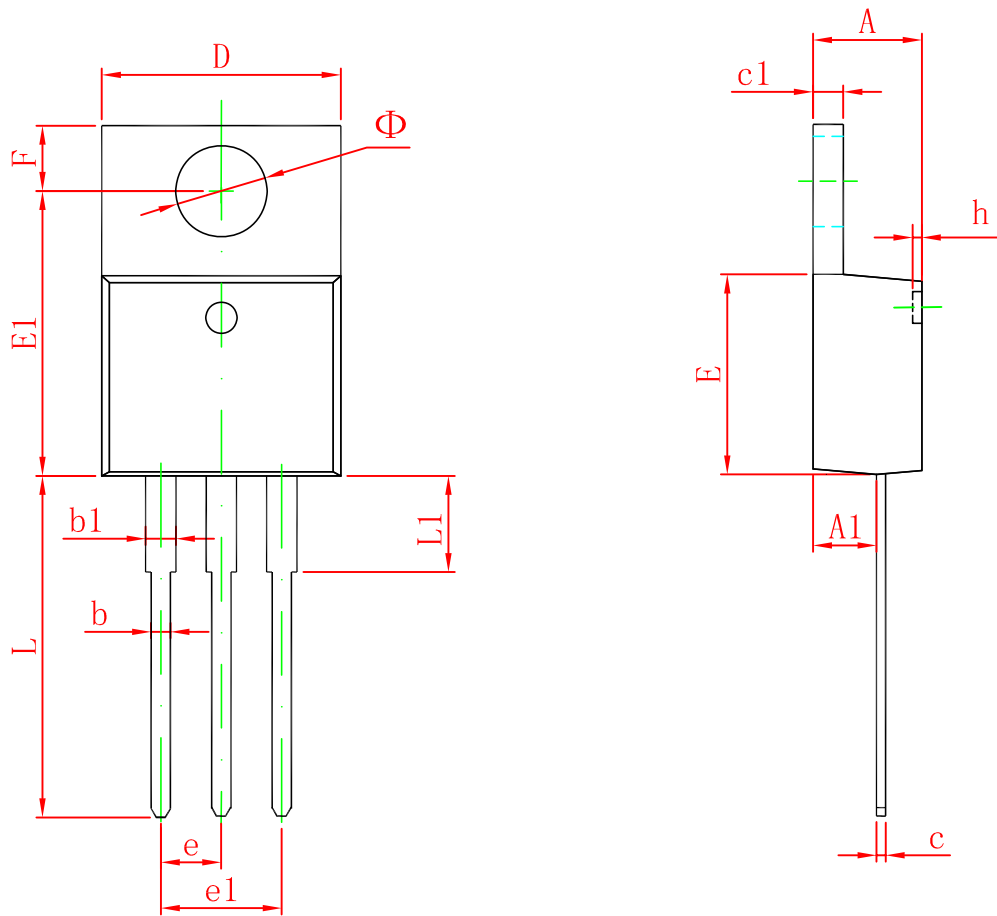

Symbol	Dimensions In Millimeters		Dimensions In Inches	
	Min	Max	Min	Max
A	4.470	4.670	0.176	0.184
A1	2.520	2.820	0.099	0.111
b	0.710	0.910	0.028	0.036
b1	1.170	1.370	0.046	0.054
c	0.310	0.530	0.012	0.021
c1	1.170	1.370	0.046	0.054
D	10.010	10.310	0.394	0.406
E	8.500	8.900	0.335	0.350
E1	12.060	12.460	0.475	0.491
e	2.540 TYP		0.100 TYP	
e1	4.980	5.180	0.196	0.204
F	2.590	2.890	0.102	0.114
h	0.000	0.300	0.000	0.012
L	13.400	13.800	0.528	0.543
L1	3.560	3.960	0.140	0.156
Φ	3.735	3.935	0.147	0.155