

Features

- Glass Passivated Die Construction
- Low leakage
- Ideal for printed circuit board
- Surge overload rating-70A peak
- Designed for Surface Mount Application
- Plastic Material-UL Flammability 94V-0

Mechanical Data

- Case: DBF, molded plastic
- Terminals:Plated Leads Solderable per MIL-STD-202,Method208
- Polarity:As Marked on Case
- Mounting Position:Any
- Marking:Type Number

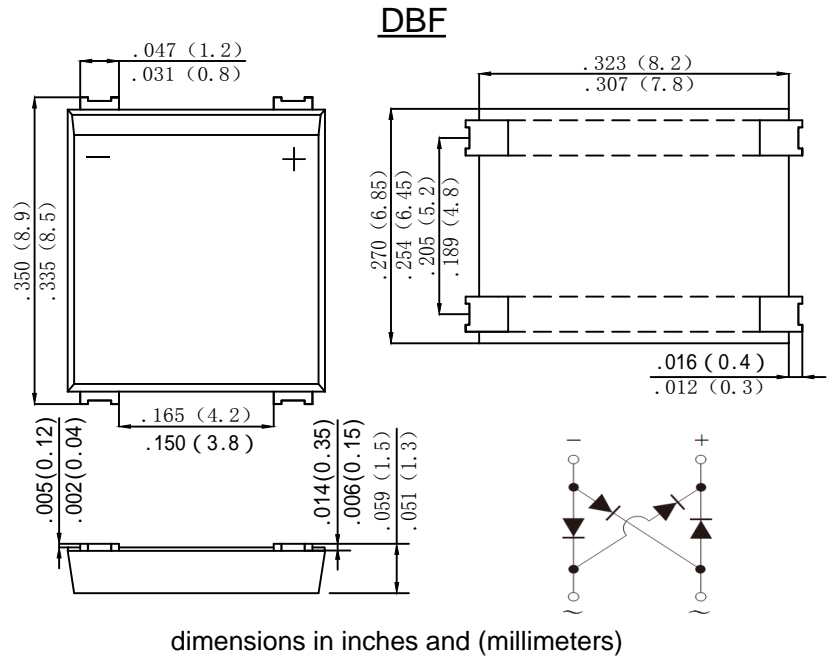

Maximum Ratings and Electrical Characteristics

Rating at 25°C ambient temperature unless otherwise specified.
 Single Phase, half wave, 60Hz, resistive or inductive load.
 For capacitive load, derate current by 20%.

TYPE NUMBER (Note 1)	SYMBOL	DBF21(H)	DBF22(H)	DBF24(H)	DBF26(H)	DBF28(H)	DBF210(H)	UNITS
Peak Repetitive Reverse Voltage	V_{RRM}							
Working Peak Reverse Voltage	V_{RWM}	100	200	400	600	800	1000	V
DC Blocking Voltage	V_{DC}							
RMS Reverse Voltage	V_{RMS}	70	140	280	420	560	700	V
Average Rectified Output Current (Note 2)@T _c =110°C	IF(AV)	2.0						A
Non-Repetitive Peak Forward Surge Current 8.3ms Single half sine-wave superimposed on rated load (JEDEC Method)	I _{FSM}	70						A
I ² t Rating for Fusing (t < 8.3ms)	I ² t	20.335						A ² s
Forward Voltage per element @IF=1.0A @IF=2.0A	V_{FM}	0.95 1.0						V
Peak Reverse Current @T _A =25°C At Rated DC Blocking Voltage @T _A =125°C	I _R	5.0 500						uA
Typical Junction Capacitance per leg (Note 3)	C _J	25						pF
Typical Thermal Resistance per leg (Note 4)	R _{θJA}	50						°C/W
	R _{θJC}	10						
Operating and Storage Temperature Range	T _J ,T _{STG}	-55to+150						°C

Note:1. "H": Halogen Free.

2. Mounted on glass epoxy PC board with 1.3mm² solder pad.

3. Measured at 1.0 MHz and applied reverse voltage of 4.0V D.C.

4. Mounted on glass-epoxy substrate with 1oz/ft² 15x15mm copper pad per pin.

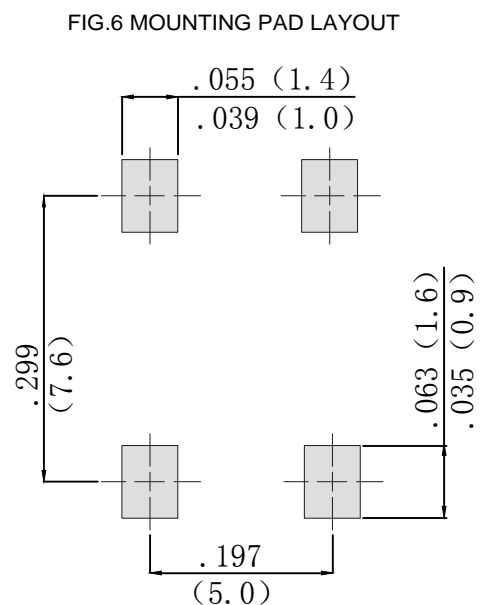
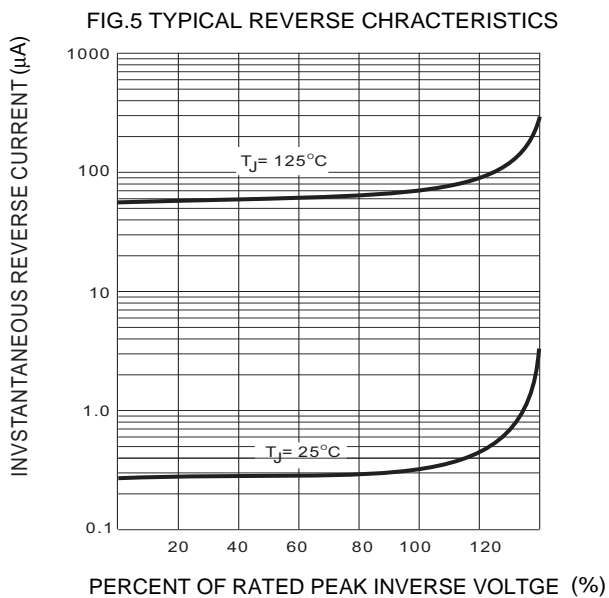
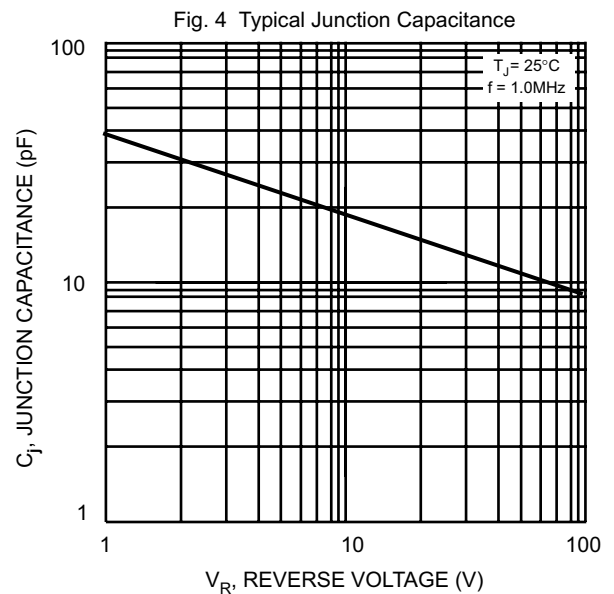
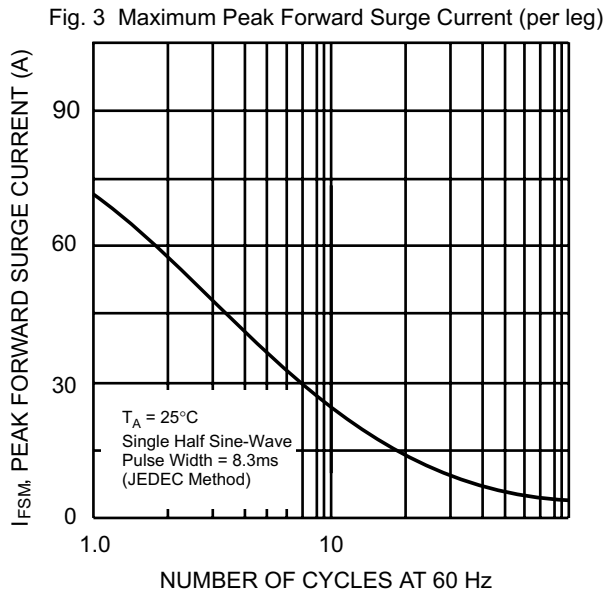
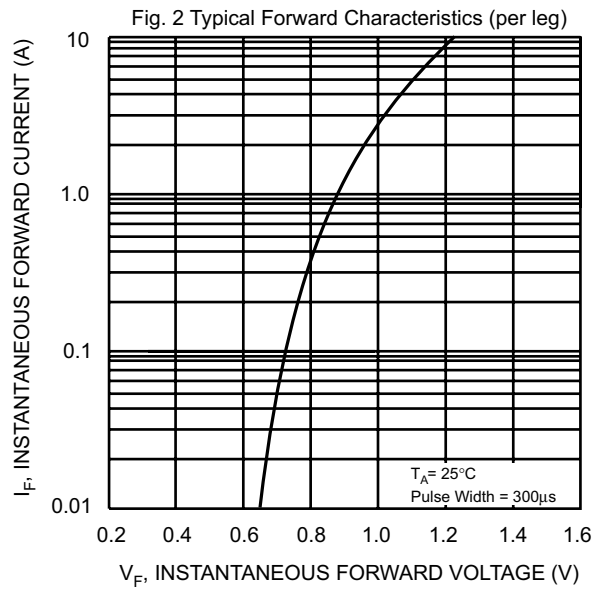
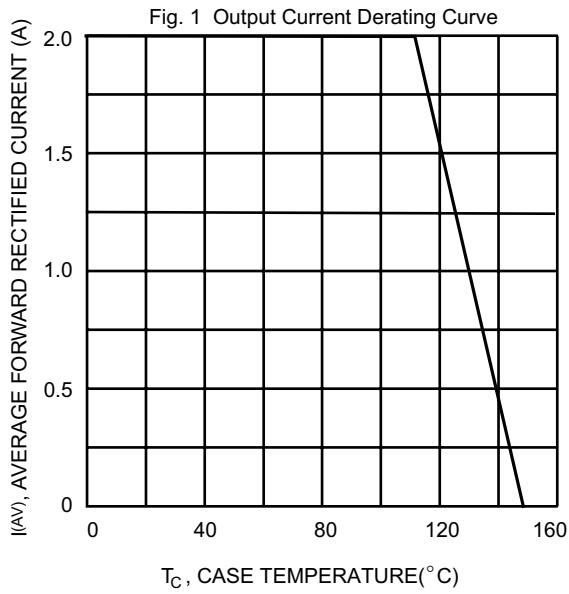

Important Notice and Disclaimer

- Reproducing and modifying information of the document is prohibited without permission from DIYI.
- DIYI reserves the right to make changes to this document and its products and specifications at any time without notice. Customers should obtain and confirm the latest product information and specifications before final design, purchase or use.
- DIYI disclaims any and all liability arising out of the application or use of any product including damages incidentally and consequentially occurred.
- DIYI does not assume any and all implied warranties, including warranties of fitness for particular purpose, non-infringement and merchantability.
- Applications shown on the herein document are examples of standard use and operation. Customers are responsible in comprehending the suitable use in particular applications.
DIYI makes no representation or warranty that such applications will be suitable for the specified use without further testing or modification.
- The products shown herein are not designed and authorized for equipments requiring high level of reliability or relating to human life and for any applications concerning life-saving or life-sustaining, such as medical instruments, transportation equipment, aerospace machinery et cetera. Customers using or selling these products for use in such applications do so at their own risk and agree to fully indemnify DIYI for any damages resulting from such improper use or sale.
- Since DIYI uses lot number as the tracking base, please provide the lot number for tracking when complaining.