

产品详细信息 introduce

其他系列 >> RJ45-B

产品订购

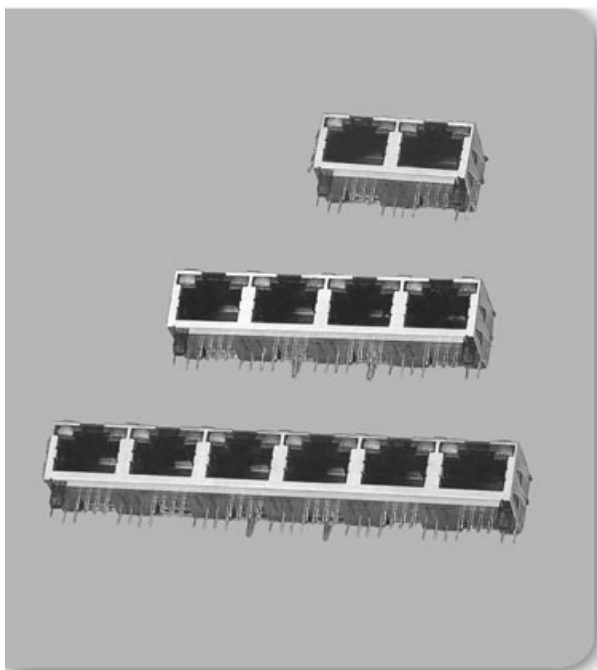

◆ SPECIFICATIONS

Unit:mm

- ◇ Temperature: -10~70℃
- ◇ Rated Load: DC125V 1.5A
- ◇ Contact Resistance: ≤ 0.03Ω
- ◇ Insulation Resistance: ≥ 1000MΩ DC100V
- ◇ Withstand Voltage: AC 1000V(50Hz)/min
- ◇ Insertion and Extraction Force: 20~80N
- ◇ Life: ≥ 750cycles

RJ45-B-1x2

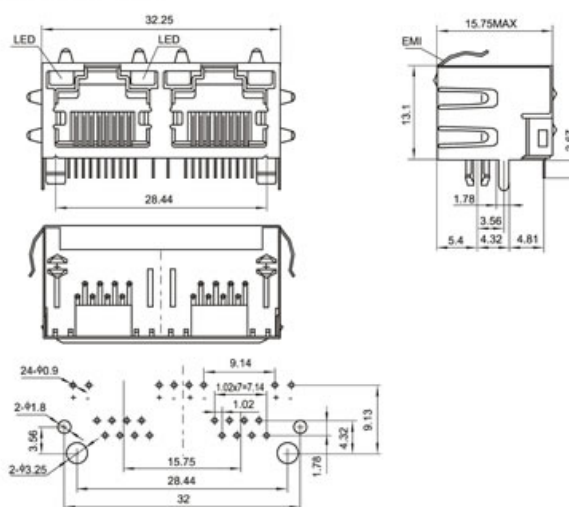

RJ45-B-1x1

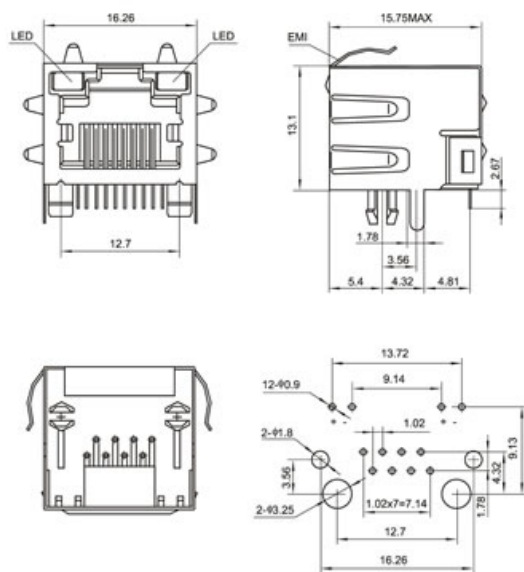

RJ45-B-1x4

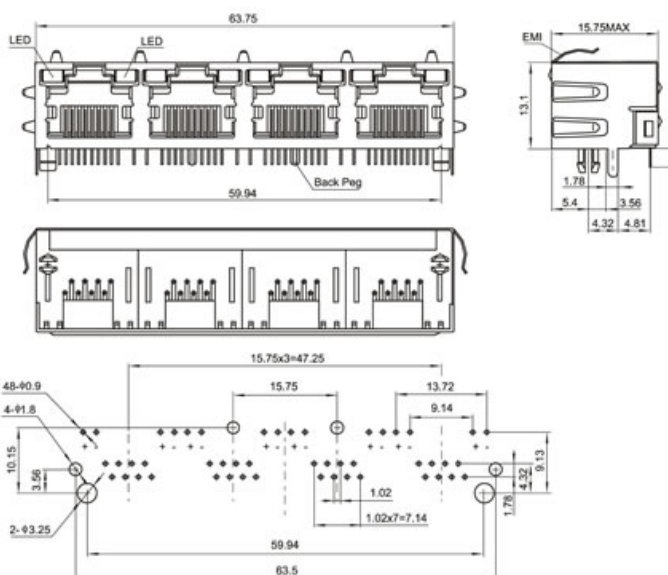

RJ45-B-1x6

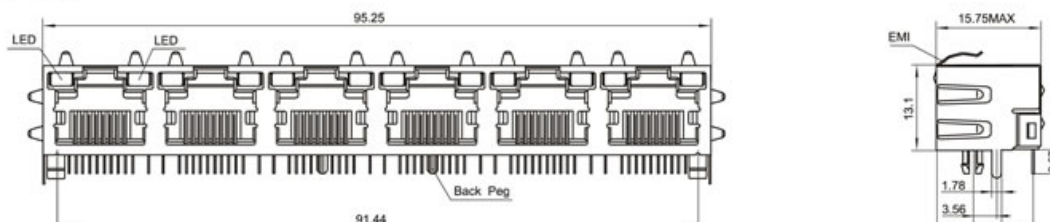

5.4 4.32 4.81

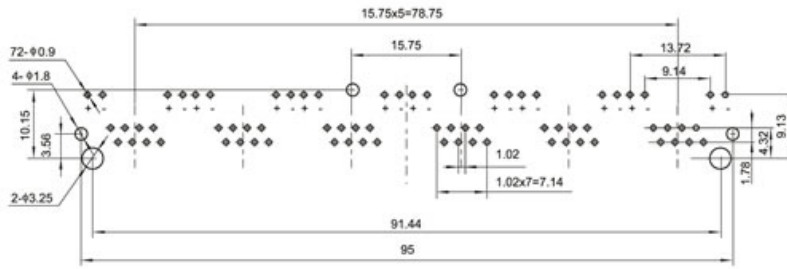
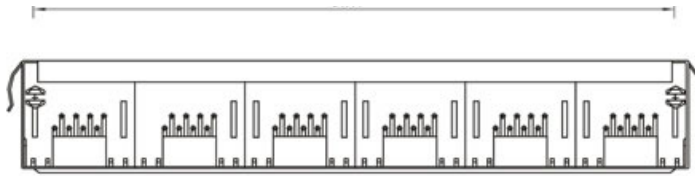

RJ45-B-1x8

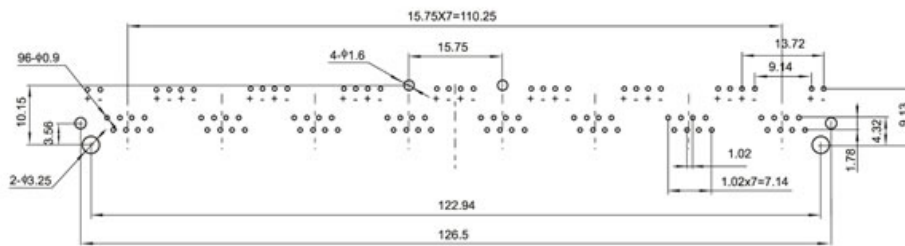
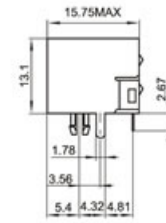
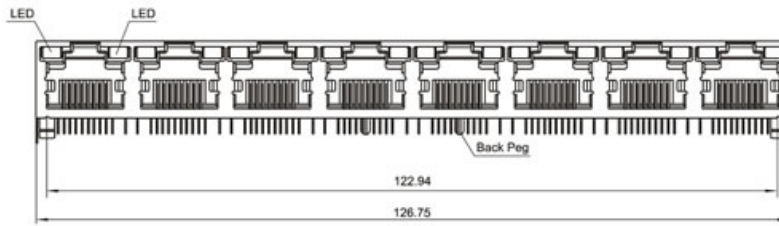

点击次数: 1821 发布时间: 2010-6-14 [【打印】](#) [【返回】](#)

产品订购