

General Description

The WSK220N04 is the highest performance trench N-Ch MOSFET with extreme high cell density, which provide excellent RDSON and gate charge for most of the synchronous buck converter applications.

The WSK220N04 meet the RoHS and Green Product requirement, 100% EAS guaranteed with full function reliability approved.

Features

- Advanced high cell density Trench technology
- Super Low Gate Charge
- Excellent CdV/dt effect decline
- 100% EAS Guaranteed
- Green Device Available

Product Summary

BVDSS	RDSON	ID
40V	2.5mΩ	220A

Applications

- Switching application
- Power Management for Inverter Systems.

TO-263 Pin Configuration

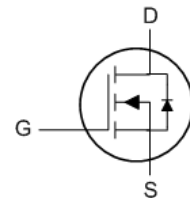
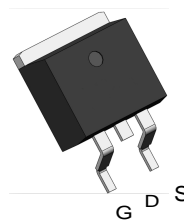

Absolute Maximum Ratings

Symbol	Parameter	Rating	Unit	
Common Ratings (T _C =25°C Unless Otherwise Noted)				
V _{DSS}	Drain-Source Voltage	40	V	
V _{GSS}	Gate-Source Voltage	±20		
T _J	Maximum Junction Temperature	175	°C	
T _{STG}	Storage Temperature Range	-55 to 175	°C	
I _S	Diode Continuous Forward Current	T _C =25°C	208	A
Mounted on Large Heat Sink				
I _{DM}	Pulsed Drain Current *	T _C =25°C	760 ^{1,2}	A
I _D	Continuous Drain Current	T _C =25°C	220	A
		T _C =100°C	139	
P _D	Maximum Power Dissipation	T _C =25°C	218	W
		T _C =100°C	109	
R _{θJC}	Thermal Resistance-Junction to Case	0.55	°C/W	
R _{θJA}	Thermal Resistance-Junction to Ambient	62.5		
Avalanche Ratings				
E _{AS}	Avalanche Energy, Single Pulsed	L=0.5mH	1.4 ^{1,2}	J

NOTE: 1, Repetitive rating; pulse width limited by junction temperature

2, Drain current is limited by junction temperature

Electrical Characteristics (T_J=25 °C, unless otherwise noted)

Symbol	Parameter	Test Conditions	Min.	Typ.	Max.	Unit
Static Characteristics						
B _V DSS	Drain-Source Breakdown Voltage	V _{GS} =0V, I _{DS} =250μA	40	-	-	V
I _{DSS}	Zero Gate Voltage Drain Current	V _{DS} =40V, V _{GS} =0V	-	-	1	μA
		T _J =85°C	-	-	10	
V _{GS(th)}	Gate Threshold Voltage	V _{DS} =V _{GS} , I _{DS} =250μA	2.0	3.0	4.0	V
I _{GSS}	Gate Leakage Current	V _{GS} =±20V, V _{DS} =0V	-	-	±100	nA
R _{DS(ON)} *	Drain-Source On-state Resistance	V _{GS} =10V, I _{DS} =104A	-	2.5	3.2	mΩ
Diode Characteristics						
V _{SD} *	Diode Forward Voltage	I _{SD} =104A, V _{GS} =0V	-	0.8	1.2	V
t _{rr}	Reverse Recovery Time	I _{SD} =104A, dI _{SD} /	-	36	-	ns
Q _{rr}	Reverse Recovery Charge	dt=100A/μs	-	59	-	nC
Dynamic Characteristics						
R _G	Gate Resistance	V _{GS} =0V, V _{DS} =0V, F=1MHz	-	1.0	-	Ω
C _{iss}	Input Capacitance	V _{GS} =0V, V _{DS} =25V, Frequency=1.0MHz	-	5710	-	pF
C _{oss}	Output Capacitance		-	1463	-	
C _{rss}	Reverse Transfer Capacitance		-	595	-	
t _{d(ON)}	Turn-on Delay Time	V _{DD} =20V, R _G =6 Ω, I _{DS} =104A, V _{GS} =10V ,	-	34	-	ns
T _r	Turn-on Rise Time		-	19	-	
t _{d(OFF)}	Turn-off Delay Time		-	44	-	
T _f	Turn-off Fall Time		-	61	-	
Gate Charge Characteristics						
Q _g	Total Gate Charge	V _{DS} =32V, V _{GS} =10V, I _{DS} =104A	-	156	-	nC
Q _{gs}	Gate-Source Charge		-	28	-	
Q _{gd}	Gate-Drain Charge		-	65	-	

Note * : Pulse test ; pulse width ≤300μs, duty cycle ≤2%.

Typical Characteristics

Drain-Source On Resistance

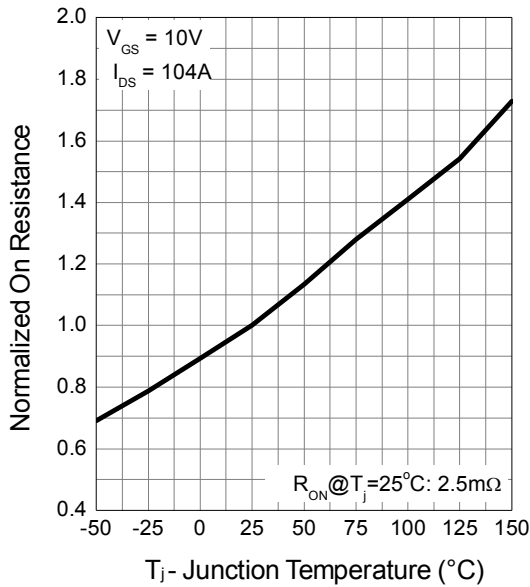

Source-Drain Diode Forward

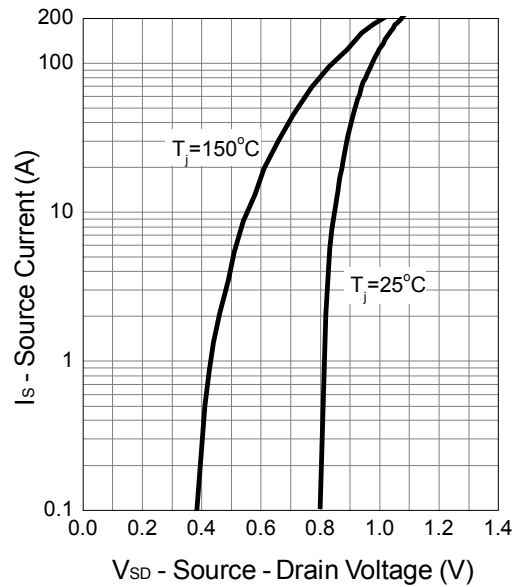

Capacitance

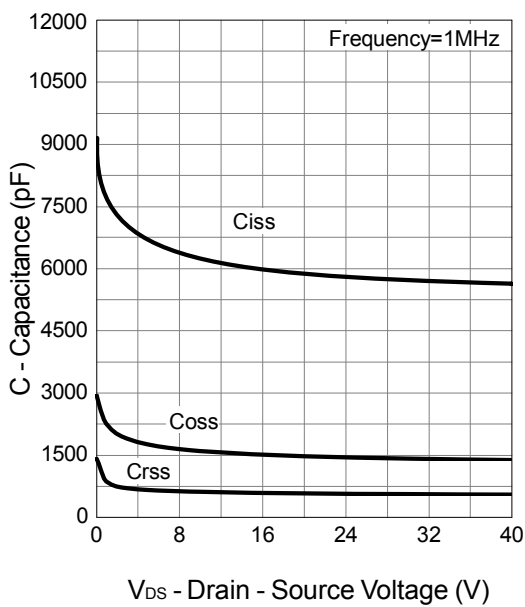

Gate Charge

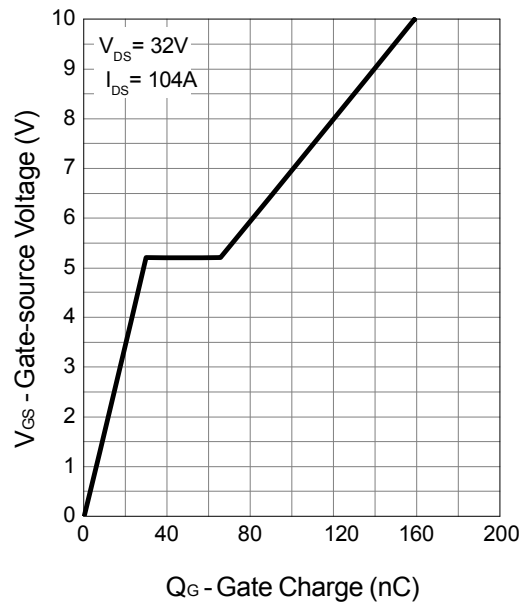

Typical Characteristics

Output Characteristics

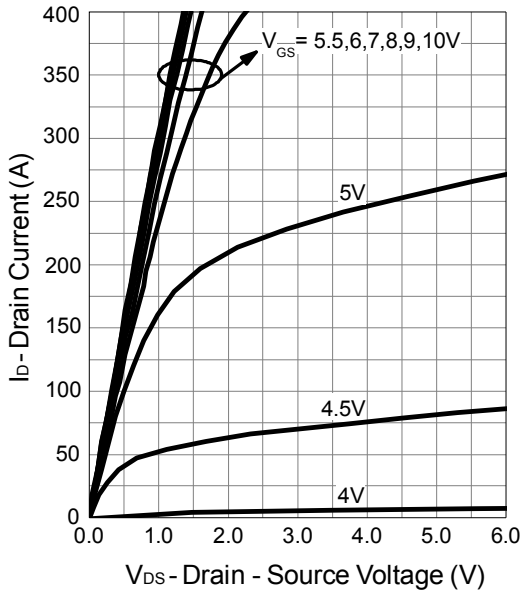

Drain-Source On Resistance

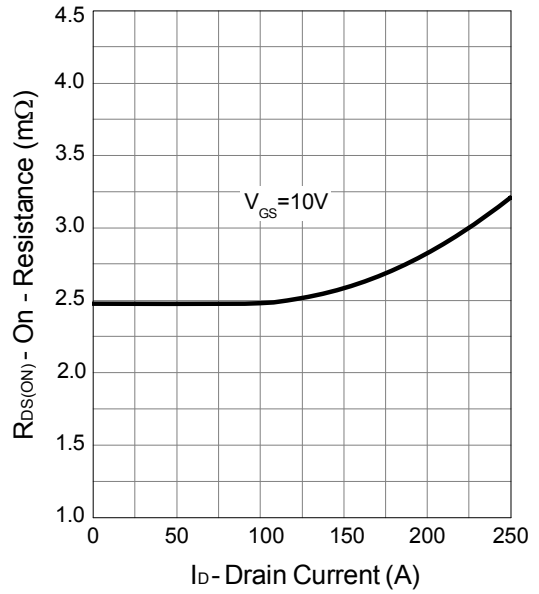

Gate-Source On Resistance

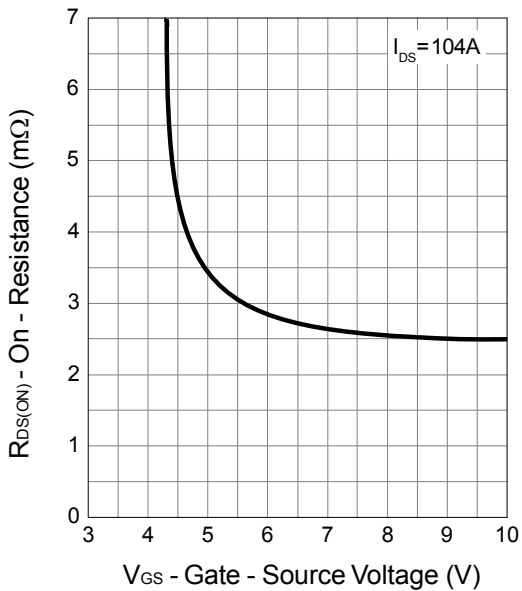

Gate Threshold Voltage

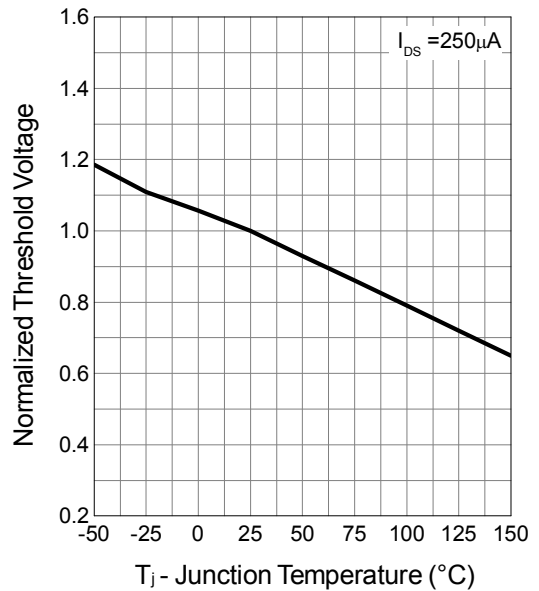

Typical Characteristics

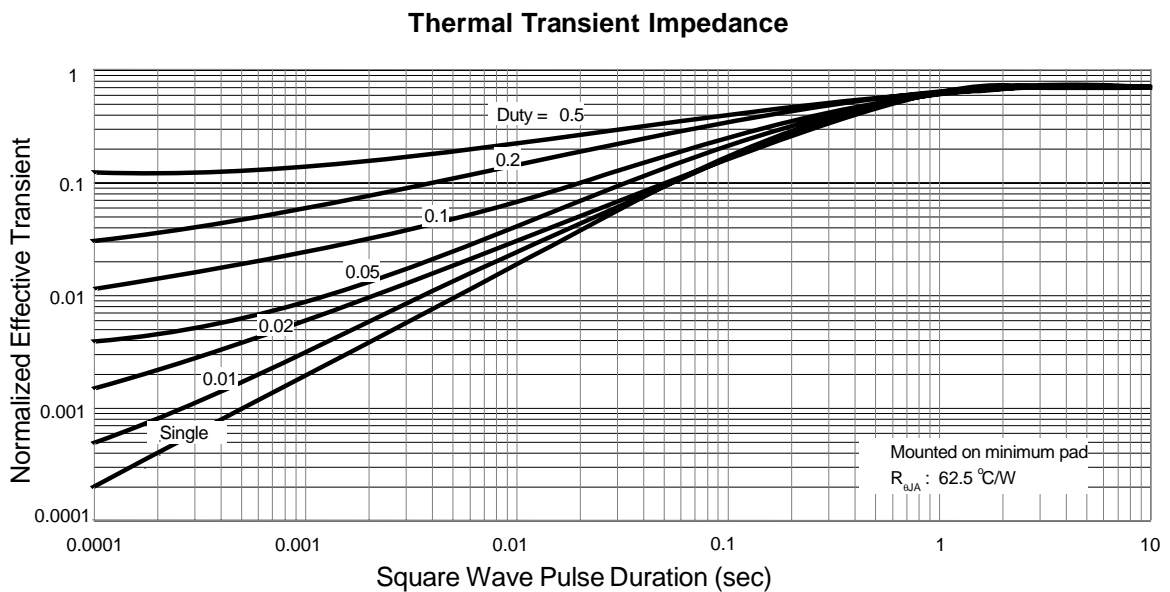
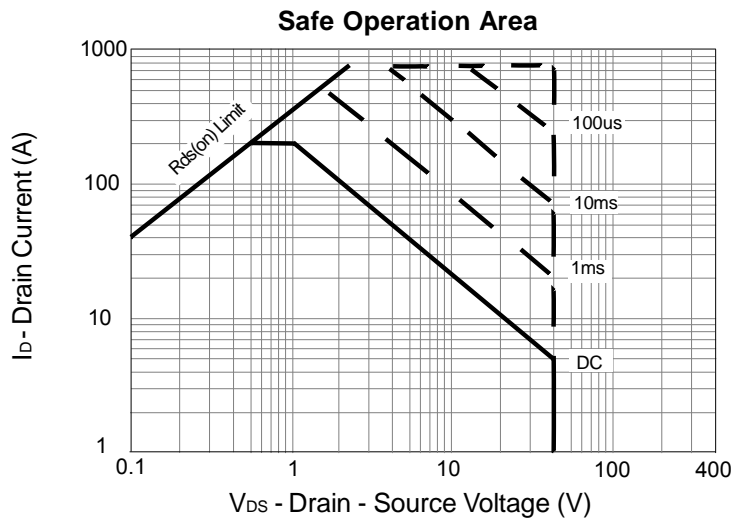
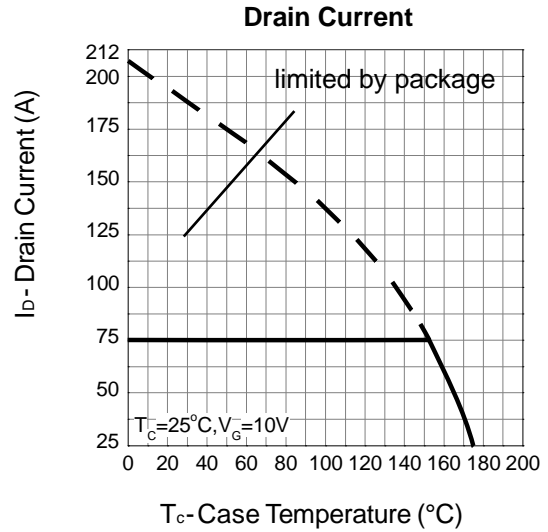
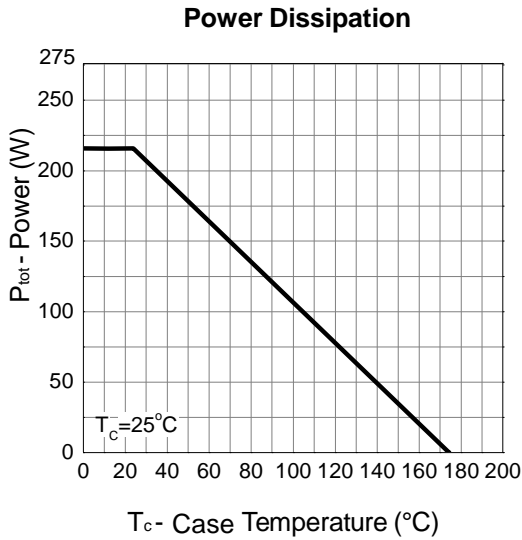

TO-263-2L

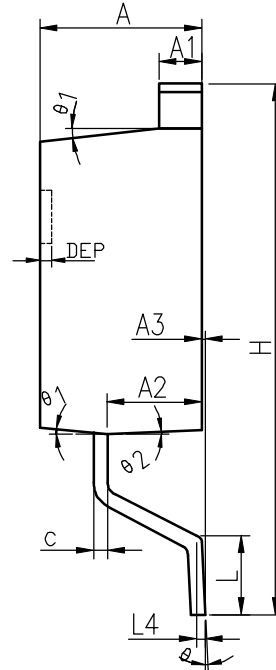
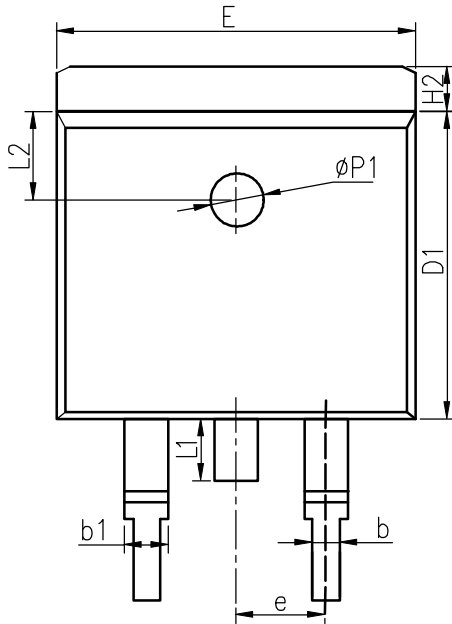

COMMON DIMENSIONS

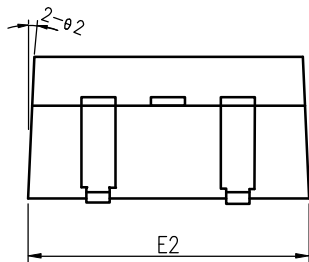

SYMBOL	MM			INCH		
	MIN	NOM	MAX	MIN	NOM	MAX
A	4.40	4.57	4.70	0.173	0.180	0.185
A1	1.22	1.27	1.32	0.048	0.050	0.052
A2	2.59	2.69	2.79	0.102	0.106	0.110
A3	0.00	0.10	0.20	0.000	0.004	0.008
b	0.77	0.813	0.90	0.030	0.032	0.035
b1	1.20	1.270	1.36	0.047	0.050	0.054
c	0.34	0.381	0.47	0.013	0.015	0.019
D1	8.60	8.70	8.80	0.339	0.343	0.346
E	10.00	10.16	10.26	0.394	0.400	0.404
E2	10.00	10.10	10.20	0.394	0.398	0.402
e	2.54 BSC			0.100 BSC		
H	14.70	15.10	15.50	0.579	0.594	0.610
H2	1.17	1.27	1.40	0.046	0.050	0.055
L	2.00	2.30	2.60	0.079	0.091	0.102
L1	1.45	1.55	1.70	0.057	0.061	0.067
L2	2.50 REF			0.098 REF		
L4	0.25 BSC			0.010 BSC		
	0°	5°	8°	0°	5°	8°
1	5°	7°	9°	5°	7°	9°
2	1°	3°	5°	1°	3°	5°
ΦP1	1.40	1.50	1.60	0.055	0.059	0.063
DEP	0.05	0.10	0.20	0.002	0.004	0.008



Attention

- 1, Any and all Winsok power products described or contained herein do not have specifications that can handle applications that require extremely high levels of reliability, such as life-support systems, aircraft's control systems, or other applications whose failure can be reasonably expected to result in serious physical and/or material damage. Consult with your Winsok power representative nearest you before using any Winsok power products described or contained herein in such applications.
- 2, Winsok power assumes no responsibility for equipment failures that result from using products at values that exceed, even momentarily, rated values (such as maximum ratings, operating condition ranges, or other parameters) listed in products specifications of any and all Winsok power products described or contained herein.
- 3, Specifications of any and all Winsok power products described or contained herein stipulate the performance, characteristics, and functions of the described products in the independent state, and are not guarantees of the performance, characteristics, and functions of the described products as mounted in the customer's products or equipment. To verify symptoms and states that cannot be evaluated in an independent device, the customer should always evaluate and test devices mounted in the customer's products or equipment.
- 4, Winsok power Semiconductor CO., LTD. strives to supply high-quality high-reliability products. However, any and all semiconductor products fail with some probability. It is possible that these probabilistic failures could give rise to accidents or events that could endanger human lives that could give rise to smoke or fire, or that could cause damage to other property. When designing equipment, adopt safety measures so that these kinds of accidents or events cannot occur. Such measures include but are not limited to protective circuits and error prevention circuits for safe design, redundant design, and structural design.
- 5, In the event that any or all Winsok power products (including technical data, services) described or contained herein are controlled under any of applicable local export control laws and regulations, such products must not be exported without obtaining the export license from the authorities concerned in accordance with the above law.
- 6, No part of this publication may be reproduced or transmitted in any form or by any means, electronic or mechanical, including photocopying and recording, or any information storage or retrieval system, or otherwise, without the prior written permission of Winsok power Semiconductor CO., LTD.
- 7, Information (including circuit diagrams and circuit parameters) herein is for example only; it is not guaranteed for volume production. Winsok power believes information herein is accurate and reliable, but no guarantees are made or implied regarding its use or any infringements of intellectual property rights or other rights of third parties.
- 8, Any and all information described or contained herein are subject to change without notice due to product/technology improvement, etc. When designing equipment, refer to the "Delivery Specification" for the Winsok power product that you intend to use.
- 9, this catalog provides information as of Sep. 2014. Specifications and information herein are subject to change without notice.