



CEP80N15/CEB80N15 CEF80N15

N-Channel Enhancement Mode Field Effect Transistor

PRELIMINARY

FEATURES

Type	V _{DSS}	R _{DS(ON)}	I _D	@V _{GS}
CEP80N15	150V	19mΩ	76A	10V
CEB80N15	150V	19mΩ	76A	10V
CEF80N15	150V	19mΩ	76A ^d	10V

- Super high dense cell design for extremely low R_{DS(ON)}.
- High power and current handling capability.
- Lead-free plating ; RoHS compliant.
- TO-220 & TO-263 & TO-220F full-pak for through hole.

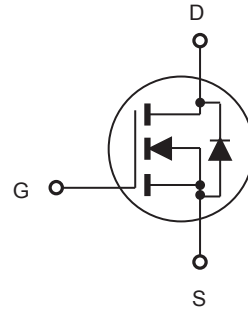
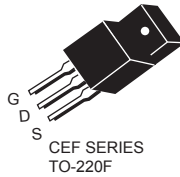

ABSOLUTE MAXIMUM RATINGS $T_C = 25^\circ\text{C}$ unless otherwise noted

Parameter	Symbol	Limit		Units
		TO-220/263	TO-220F	
Drain-Source Voltage	V _{DS}	150		V
Gate-Source Voltage	V _{GS}	±20		V
Drain Current-Continuous @ T _C = 25 C @ T _C = 100 C	I _D	76	76 ^d	A
		55	55 ^d	A
Drain Current-Pulsed ^a	I _{DM} ^e	304	304 ^d	A
Maximum Power Dissipation @ T _C = 25°C - Derate above 25°C	P _D	300	68	W
		2	0.5□	W/°C
Operating and Store Temperature Range	T _J , T _{stg}	-55 to 175		°C

Thermal Characteristics

Parameter	Symbol	Limit		Units
Thermal Resistance, Junction-to-Case	R _{θJC}	0.5	2.2	°C/W
Thermal Resistance, Junction-to-Ambient	R _{θJA}	62.5	65	°C/W

This is preliminary information on a new product in development now .
Details are subject to change without notice .

Rev 1. 2012.Mar.
<http://www.cetsemi.com>



CEP80N15/CEB80N15 CEF80N15

Electrical Characteristics $T_C = 25^\circ\text{C}$ unless otherwise noted

Parameter	Symbol	Test Condition	Min	Typ	Max	Units
Off Characteristics						
Drain-Source Breakdown Voltage	BV_{DSS}	$V_{GS} = 0V, I_D = 250\mu A$	150			V
Zero Gate Voltage Drain Current	I_{DSS}	$V_{DS} = 150V, V_{GS} = 0V$			1	μA
Gate Body Leakage Current, Forward	I_{GSSF}	$V_{GS} = 20V, V_{DS} = 0V$			100	nA
Gate Body Leakage Current, Reverse	I_{GSSR}	$V_{GS} = -20V, V_{DS} = 0V$			-100	nA
On Characteristics^b						
Gate Threshold Voltage	$V_{GS(th)}$	$V_{GS} = V_{DS}, I_D = 250\mu A$	2		4	V
Static Drain-Source On-Resistance	$R_{DS(on)}$	$V_{GS} = 10V, I_D = 35A$		14	19	m Ω
Dynamic Characteristics^c						
Input Capacitance	C_{iss}	$V_{DS} = 25V, V_{GS} = 0V,$ $f = 800KHz$		8540		pF
Output Capacitance	C_{oss}			455		pF
Reverse Transfer Capacitance	C_{rss}			365		pF
Switching Characteristics^c						
Turn-On Delay Time	$t_{d(on)}$	$V_{DD} = 76V, I_D = 38A,$ $V_{GS} = 10V, R_{GEN} = 5\Omega$		45	90	ns
Turn-On Rise Time	t_r			24	48	ns
Turn-Off Delay Time	$t_{d(off)}$			193	386	ns
Turn-Off Fall Time	t_f			33	66	ns
Total Gate Charge	Q_g	$V_{DS} = 76V, I_D = 38A,$ $V_{GS} = 10V$		262	340	nC
Gate-Source Charge	Q_{gs}			53		nC
Gate-Drain Charge	Q_{gd}			83		nC
Drain-Source Diode Characteristics and Maximum Ratings						
Drain-Source Diode Forward Current	I_S^f				76	A
Drain-Source Diode Forward Voltage ^b	V_{SD}	$V_{GS} = 0V, I_S = 76A^g$			1.2	V
Notes : □ a.Repetitive Rating : Pulse width limited by maximum junction temperature . b.Pulse Test : Pulse Width $\leq 300\mu s$, Duty Cycle $\leq 2\%$. □ c.Guaranteed by design, not subject to production testing. □ d.Limited only by maximum temperature allowed . e .Pulse width limited by safe operating area . f .Full package $I_{S(max)} = 37A$. g.Full package V_{SD} test condition $I_S = 37A$.						



CEP80N15/CEB80N15 CEF80N15

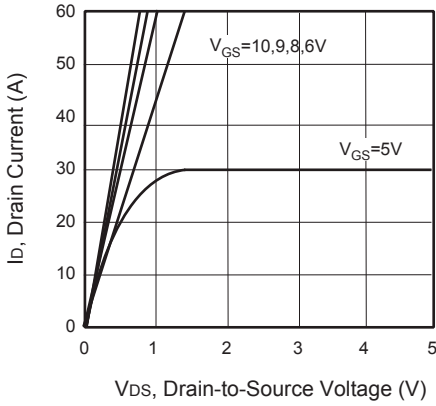

Figure 1. Output Characteristics

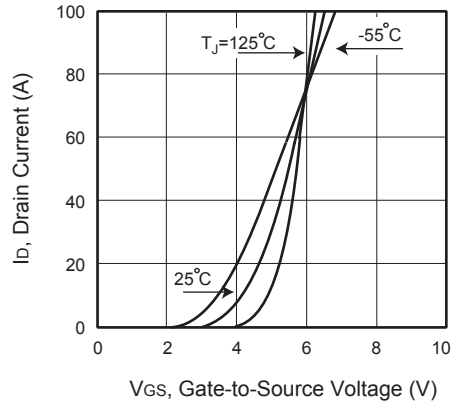

Figure 2. Transfer Characteristics

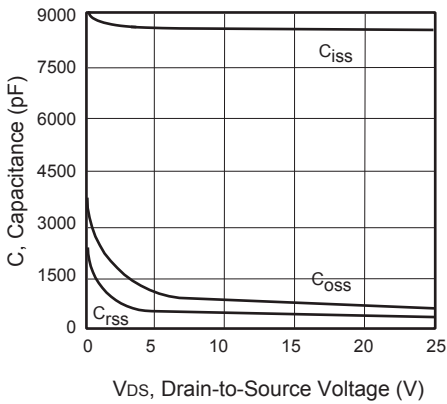

Figure 3. Capacitance

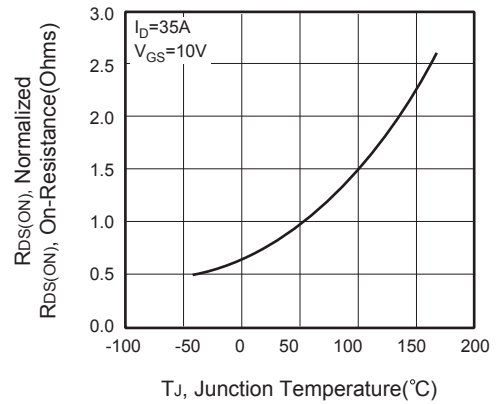

Figure 4. On-Resistance Variation with Temperature



Figure 5. Gate Threshold Variation with Temperature

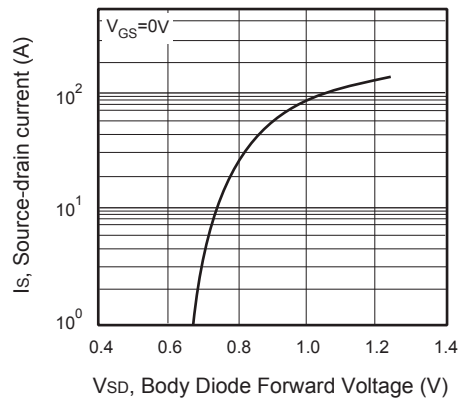

Figure 6. Body Diode Forward Voltage Variation with Source Current



CEP80N15/CEB80N15 CEF80N15

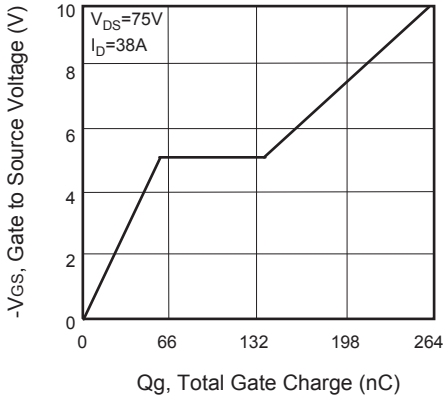

Figure 7. Gate Charge

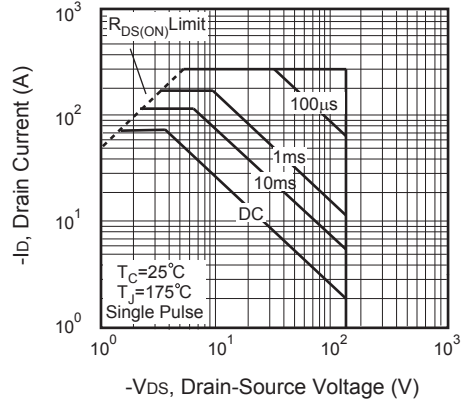

Figure 8. Maximum Safe Operating Area

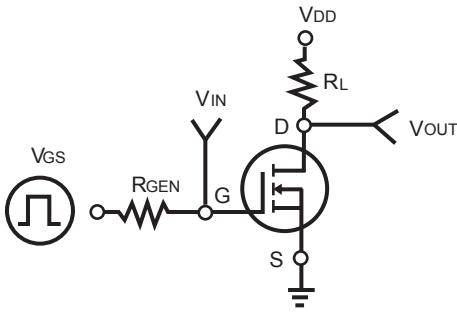

Figure 9. Switching Test Circuit

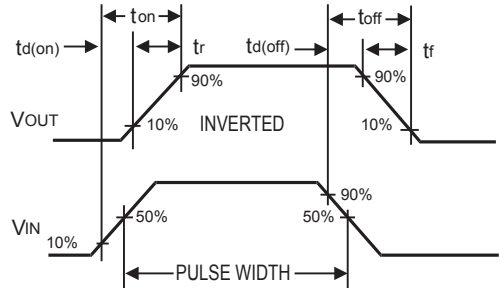

Figure 10. Switching Waveforms

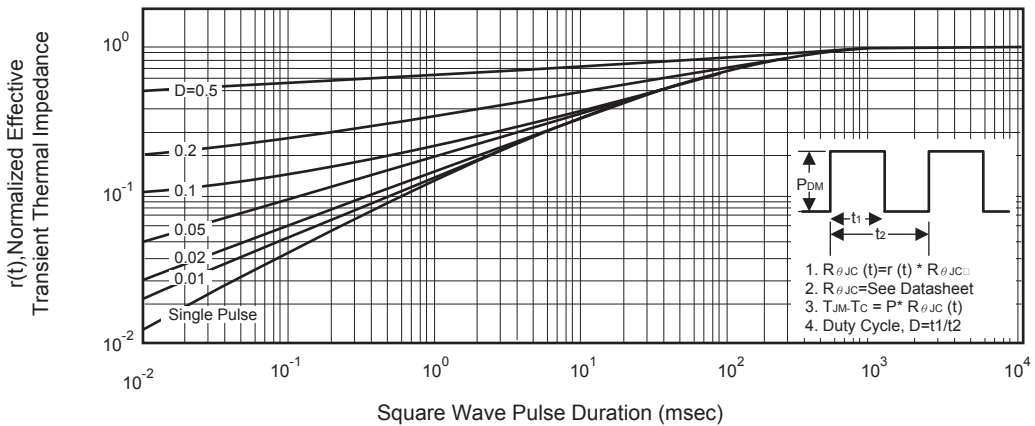

Figure 11. Normalized Thermal Transient Impedance Curve