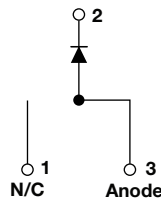

# HEXFRED<sup>®</sup>, Ultrafast Soft Recovery Diode, 4 A

 TO-263AB (D<sup>2</sup>PAK)

**FEATURES**

- Ultrafast recovery
- Ultrasoft recovery
- Very low  $I_{RRM}$
- Very low  $Q_{rr}$
- Specified at operating temperature
- Meets MSL level 1, per J-STD-020, LF maximum peak of 260 °C
- AEC-Q101 qualified
- Material categorization: for definitions of compliance please see [www.vishay.com/doc?99912](http://www.vishay.com/doc?99912)

**RoHS**  
COMPLIANT  
HALOGEN  
**FREE**
**BENEFITS**

- Reduced RFI and EMI
- Reduced power loss in diode and switching transistor
- Higher frequency operation
- Reduced snubbing
- Reduced parts count

**DESCRIPTION**

VS-HFA04TB60S is a state of the art ultrafast recovery diode. Employing the latest in epitaxial construction and advanced processing techniques it features a superb combination of characteristics which result in performance which is unsurpassed by any rectifier previously available. With basic ratings of 600 V and 4 A continuous current, the VS-HFA04TB60S is especially well suited for use as the companion diode for IGBTs and MOSFETs. In addition to ultrafast recovery time, the HEXFRED<sup>®</sup> product line features extremely low values of peak recovery current ( $I_{RRM}$ ) and does not exhibit any tendency to “snap-off” during the  $t_b$  portion of recovery. The HEXFRED features combine to offer designers a rectifier with lower noise and significantly lower switching losses in both the diode and the switching transistor. These HEXFRED advantages can help to significantly reduce snubbing, component count and heatsink sizes. The HEXFRED VS-HFA04TB60S is ideally suited for applications in power supplies and power conversion systems (such as inverters), motor drives, and many other similar applications where high speed, high efficiency is needed.

PRODUCT SUMMARY	
Package	TO-263AB (D <sup>2</sup> PAK)
$I_{F(AV)}$	4 A
$V_R$	600 V
$V_F$ at $I_F$	1.4 V
$t_{rr}$ (typ.)	17 ns
$T_J$ max.	150 °C
Diode variation	Single die

ABSOLUTE MAXIMUM RATINGS				
PARAMETER	SYMBOL	TEST CONDITIONS	VALUES	UNITS
Cathode to anode voltage	$V_R$		600	V
Maximum continuous forward current	$I_F$	$T_C = 100\text{ °C}$	4	A
Single pulse forward current	$I_{FSM}$		25	
Maximum repetitive forward current	$I_{FRM}$		16	
Maximum power dissipation	$P_D$	$T_C = 25\text{ °C}$	25	W
		$T_C = 100\text{ °C}$	10	
Operating junction and storage temperature range	$T_J, T_{Stg}$		-55 to +150	°C



<b>ELECTRICAL SPECIFICATIONS</b> ( $T_J = 25\text{ }^\circ\text{C}$ unless otherwise specified)						
PARAMETER	SYMBOL	TEST CONDITIONS	MIN.	TYP.	MAX.	UNITS
Cathode to anode breakdown voltage	$V_{BR}$	$I_R = 100\text{ }\mu\text{A}$	600	-	-	
Maximum forward voltage	$V_{FM}$	$I_F = 4.0\text{ A}$	-	1.5	1.8	V
		$I_F = 8.0\text{ A}$	-	1.8	2.2	
		$I_F = 4.0\text{ A}, T_J = 125\text{ }^\circ\text{C}$	-	1.4	1.7	
Maximum reverse leakage current	$I_{RM}$	$V_R = V_R\text{ rated}$	-	0.17	3.0	$\mu\text{A}$
		$T_J = 125\text{ }^\circ\text{C}, V_R = 0.8 \times V_R\text{ rated}$	-	44	300	
Junction capacitance	$C_T$	$V_R = 200\text{ V}$	-	4.0	8.0	pF
Series inductance	$L_S$	Measured lead to lead 5 mm from package body	-	8.0	-	nH

<b>DYNAMIC RECOVERY CHARACTERISTICS</b> ( $T_J = 25\text{ }^\circ\text{C}$ unless otherwise specified)						
PARAMETER	SYMBOL	TEST CONDITIONS	MIN.	TYP.	MAX.	UNITS
Reverse recovery time See fig. 5, 6	$t_{rr}$	$I_F = 1.0\text{ A}, dI_F/dt = 200\text{ A}/\mu\text{s}, V_R = 30\text{ V}$	-	17	-	ns
	$t_{rr1}$	$T_J = 25\text{ }^\circ\text{C}$	-	28	42	
	$t_{rr2}$	$T_J = 125\text{ }^\circ\text{C}$	-	38	57	
Peak recovery current	$I_{RRM1}$	$T_J = 25\text{ }^\circ\text{C}$	-	2.9	5.2	A
	$I_{RRM2}$	$T_J = 125\text{ }^\circ\text{C}$	-	3.7	6.7	
Reverse recovery charge See fig. 7	$Q_{rr1}$	$T_J = 25\text{ }^\circ\text{C}$	-	40	60	nC
	$Q_{rr2}$	$T_J = 125\text{ }^\circ\text{C}$	-	70	105	
Peak rate of fall of recovery current during $t_b$ See fig. 8	$dI_{(rec)M}/dt1$	$T_J = 25\text{ }^\circ\text{C}$	-	280	-	$\text{A}/\mu\text{s}$
	$dI_{(rec)M}/dt2$	$T_J = 125\text{ }^\circ\text{C}$	-	235	-	

<b>THERMAL - MECHANICAL SPECIFICATIONS</b>						
PARAMETER	SYMBOL	TEST CONDITIONS	MIN.	TYP.	MAX.	UNITS
Lead temperature	$T_{lead}$	0.063" from case (1.6 mm) for 10 s	-	-	300	$^\circ\text{C}$
Thermal resistance, junction to case	$R_{thJC}$		-	-	5.0	K/W
Thermal resistance, junction to ambient	$R_{thJA}$	Typical socket mount	-	-	80	
Weight			-	2.0	-	g
			-	0.07	-	oz.
Marking device		Case style TO-263AB (D <sup>2</sup> PAK)	HFA04TB60S			

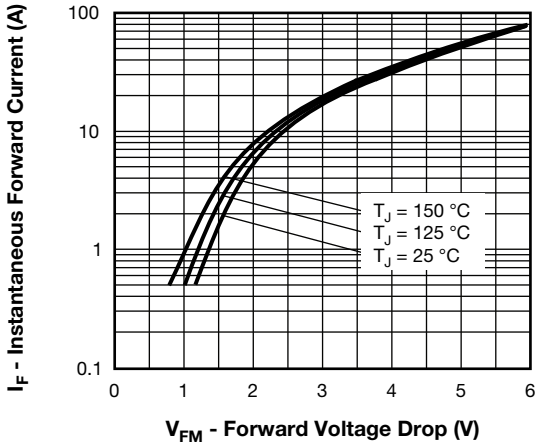

Fig. 1 - Maximum Forward Voltage Drop vs. Instantaneous Forward Current

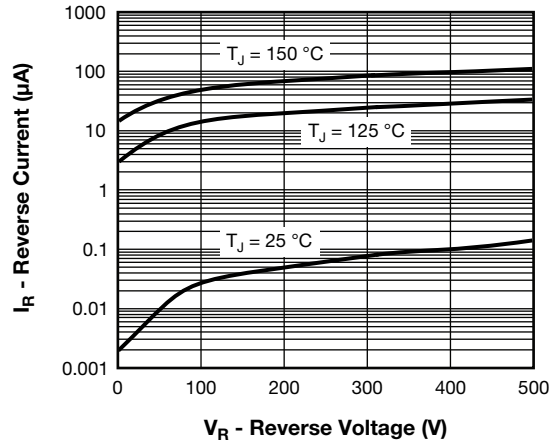

Fig. 2 - Typical Reverse Current vs. Reverse Voltage

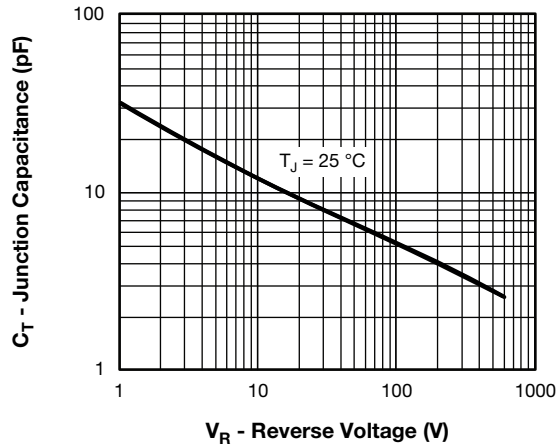

Fig. 3 - Typical Junction Capacitance vs. Reverse Voltage

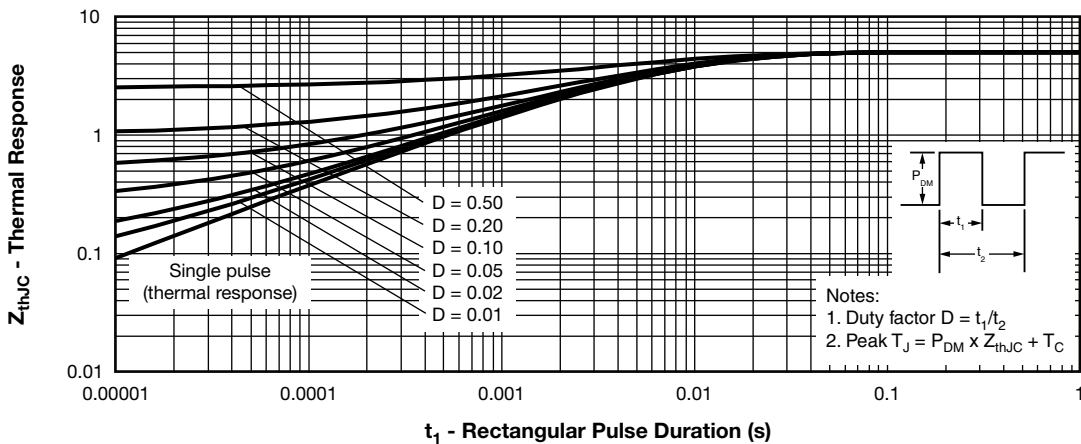

Fig. 4 - Maximum Thermal Impedance  $Z_{thJC}$  Characteristics

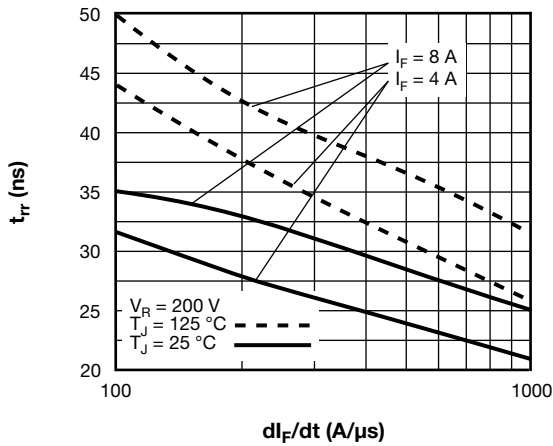

Fig. 5 - Typical Reverse Recovery Time vs. di/dt

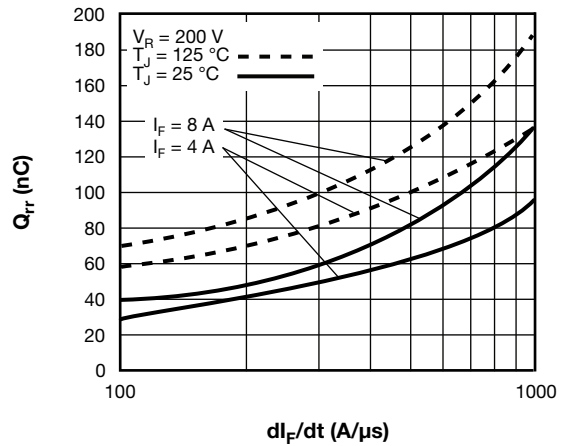

Fig. 7 - Typical Stored Charge vs. di/dt

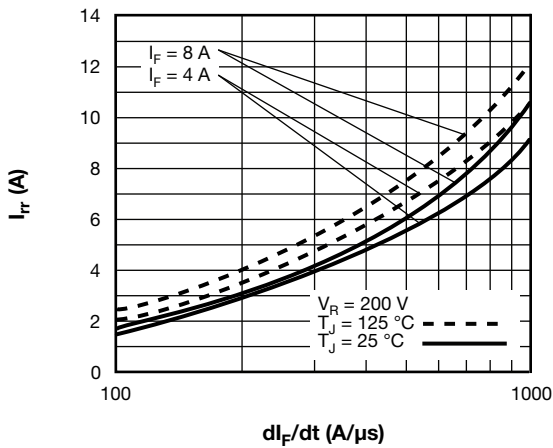

Fig. 6 - Typical Recovery Current vs. di/dt

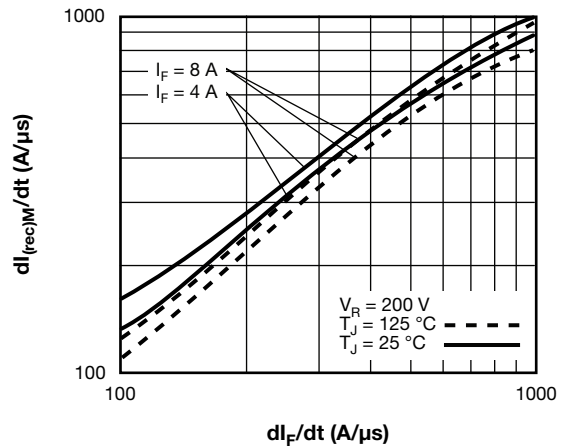

Fig. 8 - Typical di(rec)M/dt vs. di/dt

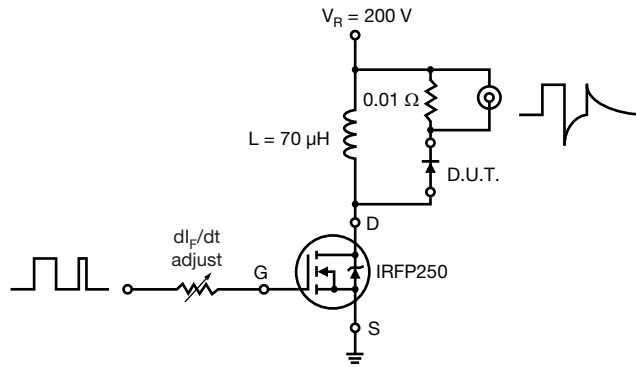
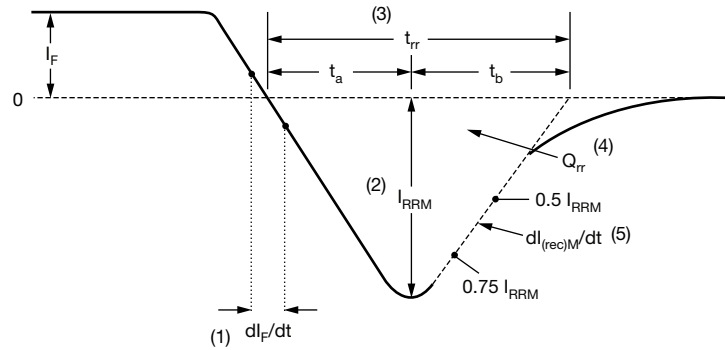

Fig. 9 - Reverse Recovery Parameter Test Circuit



- (1)  $di_F/dt$  - rate of change of current through zero crossing
- (2)  $I_{RRM}$  - peak reverse recovery current
- (3)  $t_{rr}$  - reverse recovery time measured from zero crossing point of negative going  $I_F$  to point where a line passing through  $0.75 I_{RRM}$  and  $0.50 I_{RRM}$  extrapolated to zero current.
- (4)  $Q_{rr}$  - area under curve defined by  $t_{rr}$  and  $I_{RRM}$
- (5)  $dl_{(rec)M}/dt$  - peak rate of change of current during  $t_b$  portion of  $t_{rr}$

$$Q_{rr} = \frac{t_{rr} \times I_{RRM}}{2}$$

Fig. 10 - Reverse Recovery Waveform and Definitions



## ORDERING INFORMATION TABLE

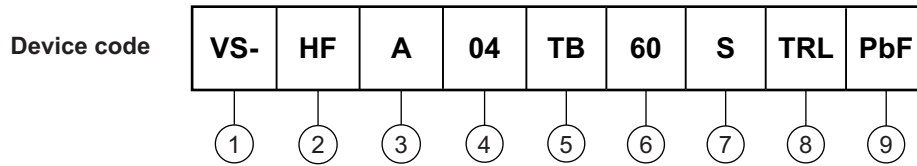

- 1** - Vishay Semiconductors product
- 2** - HEXFRED® family
- 3** - Process designator: A = electron irradiated
- 4** - Current rating (04 = 4 A)
- 5** - Package outline (TB = TO-220, 2 leads)
- 6** - Voltage rating (60 = 600 V)
- 7** - S = D<sup>2</sup>PAK
- 8** -
  - None = tube (50 pieces)
  - TRL = tape and reel (left oriented)
  - TRR = tape and reel (right oriented)
- 9** -
  - PbF = lead (Pb)-free, for tube packaged
  - P = lead (Pb)-free, for tape and reel packaged

<b>ORDERING INFORMATION</b> (Example)			
<b>PREFERRED P/N</b>	<b>QUANTITY PER TUBE OR TAPE AND REEL</b>	<b>MINIMUM ORDER QUANTITY</b>	<b>PACKAGING DESCRIPTION</b>
VS-HFA04TB60SPBF	50	1000	Antistatic plastic tube
VS-HFA04TB60STRLP	800	800	13" diameter reel
VS-HFA04TB60STRRP	800	800	13" diameter reel

<b>LINKS TO RELATED DOCUMENTS</b>	
Dimensions	<a href="http://www.vishay.com/doc?95046">www.vishay.com/doc?95046</a>
Part marking information	<a href="http://www.vishay.com/doc?95054">www.vishay.com/doc?95054</a>
Packaging information	<a href="http://www.vishay.com/doc?95032">www.vishay.com/doc?95032</a>

## D<sup>2</sup>PAK

### DIMENSIONS in millimeters and inches

Conforms to JEDEC® outline D<sup>2</sup>PAK (SMD-220)



SYMBOL	MILLIMETERS		INCHES		NOTES	SYMBOL	MILLIMETERS		INCHES		NOTES
	MIN.	MAX.	MIN.	MAX.			MIN.	MAX.	MIN.	MAX.	
A	4.06	4.83	0.160	0.190		D1	6.86	8.00	0.270	0.315	3
A1	0.00	0.254	0.000	0.010		E	9.65	10.67	0.380	0.420	2, 3
b	0.51	0.99	0.020	0.039		E1	7.90	8.80	0.311	0.346	3
b1	0.51	0.89	0.020	0.035	4	e	2.54 BSC		0.100 BSC		
b2	1.14	1.78	0.045	0.070		H	14.61	15.88	0.575	0.625	
b3	1.14	1.73	0.045	0.068	4	L	1.78	2.79	0.070	0.110	
c	0.38	0.74	0.015	0.029		L1	-	1.65	-	0.066	3
c1	0.38	0.58	0.015	0.023	4	L2	1.27	1.78	0.050	0.070	
c2	1.14	1.65	0.045	0.065		L3	0.25 BSC		0.010 BSC		
D	8.51	9.65	0.335	0.380	2	L4	4.78	5.28	0.188	0.208	

#### Notes

- Dimensioning and tolerancing per ASME Y14.5 M-1994
- Dimension D and E do not include mold flash. Mold flash shall not exceed 0.127 mm (0.005") per side. These dimensions are measured at the outmost extremes of the plastic body
- Thermal pad contour optional within dimension E, L1, D1 and E1
- Dimension b1 and c1 apply to base metal only
- Datum A and B to be determined at datum plane H
- Controlling dimension: inch
- Outline conforms to JEDEC® outline TO-263AB



## **Disclaimer**

ALL PRODUCT, PRODUCT SPECIFICATIONS AND DATA ARE SUBJECT TO CHANGE WITHOUT NOTICE TO IMPROVE RELIABILITY, FUNCTION OR DESIGN OR OTHERWISE.

Vishay Intertechnology, Inc., its affiliates, agents, and employees, and all persons acting on its or their behalf (collectively, "Vishay"), disclaim any and all liability for any errors, inaccuracies or incompleteness contained in any datasheet or in any other disclosure relating to any product.

Vishay makes no warranty, representation or guarantee regarding the suitability of the products for any particular purpose or the continuing production of any product. To the maximum extent permitted by applicable law, Vishay disclaims (i) any and all liability arising out of the application or use of any product, (ii) any and all liability, including without limitation special, consequential or incidental damages, and (iii) any and all implied warranties, including warranties of fitness for particular purpose, non-infringement and merchantability.

Statements regarding the suitability of products for certain types of applications are based on Vishay's knowledge of typical requirements that are often placed on Vishay products in generic applications. Such statements are not binding statements about the suitability of products for a particular application. It is the customer's responsibility to validate that a particular product with the properties described in the product specification is suitable for use in a particular application. Parameters provided in datasheets and / or specifications may vary in different applications and performance may vary over time. All operating parameters, including typical parameters, must be validated for each customer application by the customer's technical experts. Product specifications do not expand or otherwise modify Vishay's terms and conditions of purchase, including but not limited to the warranty expressed therein.

Except as expressly indicated in writing, Vishay products are not designed for use in medical, life-saving, or life-sustaining applications or for any other application in which the failure of the Vishay product could result in personal injury or death. Customers using or selling Vishay products not expressly indicated for use in such applications do so at their own risk. Please contact authorized Vishay personnel to obtain written terms and conditions regarding products designed for such applications.

No license, express or implied, by estoppel or otherwise, to any intellectual property rights is granted by this document or by any conduct of Vishay. Product names and markings noted herein may be trademarks of their respective owners.