

4 MINIATURE ALUMINUM ELECTROLYTIC CAPACITORS



MINIATURE ALUMINUM ELECTROLYTIC CAPACITORS

PART NUMBER SYSTEM

● Part Number System

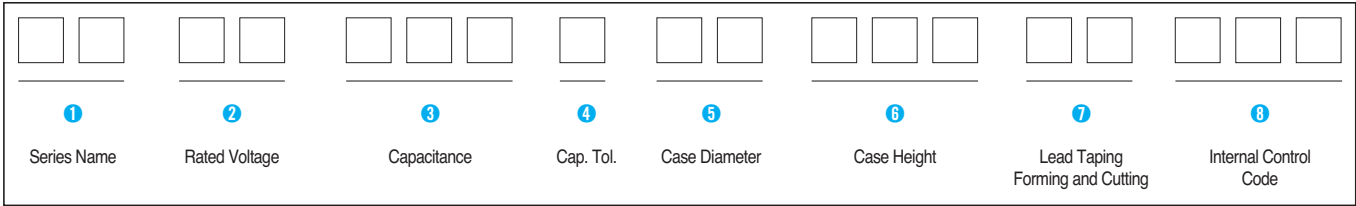

1 Series Name
See page 4~5.

2 Rated Working Voltage

WV	2.5	4	6.3	10	16	20	25
Code	0E	0G	0J	1A	1C	1D	1E
WV	35	40	50	63	80	100	160
Code	1V	1G	1H	1J	1K	2A	2C
WV	200	250	315	350	400	450	500
Code	2D	2E	2F	2V	2G	2W	2H

3 Capacitance

ex) 0.47 μ F 474
 4.7 μ F 475
 47 μ F 476
 470 μ F 477
 4700 μ F 478
 47000 μ F 479

4 Capacitance Tolerance

Tolerance (%)	± 10	± 20	$\begin{matrix} -10 \\ +20 \end{matrix}$	$\begin{matrix} -10 \\ +30 \end{matrix}$	$\begin{matrix} -10 \\ +50 \end{matrix}$
Code	K	M	V	Q	T

5 Case Diameter

ex) $\varnothing 3$ 03 $\varnothing 12.5$ 12
 $\varnothing 4$ 04 $\varnothing 16$ 16
 $\varnothing 5$ 05 $\varnothing 18$ 18
 $\varnothing 6.3$ 6L $\varnothing 22$ 22
 $\varnothing 8$ 08 $\varnothing 25.4$ 25
 $\varnothing 10$ 10

6 Case Height
 ex) 5mm 005
 11mm 011
 12.5mm 12M
 20mm 020
 31.5mm 31M
 35.5mm 35M

7 Lead Taping, Forming and Cutting
 See pages 84 ~ 86

PACKING

● BULK PACKING QUANTITY(pcs) / BOX

SIZE		BULK (QUANTITY)		
∅D	L(mm)	V-Bag	INNER BOX	MIDDLE BOX
3	5	500	12000	48000
4	5, 7	500	10000	40000
5	5, 7, 9, 11	500	7000	28000
6.3	5, 7, 9, 11	500	6000	24000
8	5	500	5000	20000
	9, 11.5	300	3600	14400
10	9, 12.5	200	2400	9600
	16	200	2000	8000
	20, 25	200	1600	6400
12.5	16	100	1200	4800
	20	100	1000	4000
	25	100	900	3600
16	16	100	800	3200
	20	50	600	2400
	25	50	500	2000
	31.5, 35.5	50	400	1600
18	16	50	600	2400
	20	50	500	2000
	20, 25, 31.5	50	400	1600
	35.5	50	300	1200

● CUTTING PACKING QUANTITY(pcs) / BOX

SIZE		CUTTING (QUANTITY)		
∅D	L(mm)	V-Bag	INNER BOX	MIDDLE BOX
4	5, 7	500	9000	36000
5	5, 7, 9, 11	500	7000	28000
6.3	5, 7, 9, 11	500	6000	24000
8	5	500	5000	20000
	9, 11.5	300	3600	14400
10	9		1000	8000(16000)
	12.5		800	6400(12800)
	16		700	5600(11200)
	20		500	4000(8000)
	25		400	3200(6400)
	30		900	2700
	40 ↑		900	1800
12.5	16		400	3200(6400)
	20		300	2400(4800)
	25		250	2000(4000)
	40 ↑		600	1200
16	16		400	1200
	20		400	1200
	25, 31.5		400	1200
	35.5		400	1200
	40 ↑		400	1200
18	16		300	900
	20		300	900
	25		300	900
	31.5, 35.5		300	900
	40 ↑		300	900
20	41		240	720
22	35.5 ↓		200	600
	40 ↑		200	600
25.4	35.5 ↓		100	300
	40 ↑		100	300

*() is for oversea

MINIATURE TYPES

MINIATURE ALUMINUM ELECTROLYTIC CAPACITORS

● Lead Forming & Cutting

Unit : mm

Configurations	Case dia.	Shape	Code	Drawing	
				L	F
T - Type	$\varnothing D \leq 8$		TS	4.5	5.0
S - Type	$\varnothing D \geq 10$		SS	4.5	-
F - Type	$\varnothing D \leq 8$		FS	5.0	5.0
C - Type	ALL		CS	5.0	-

Configurations	Case dia.	Shape	Drawing		
			M	N	
	$\varnothing D \geq 8$				
D - Type	Code	DL	DR	3.0	3.2
H - Type		HL	HR	3.0	3.7
M - Type		ML	MR	6.0	2.5
Q - Type		QL	QR	6.0	1.5
J - Type		JL	JR	6.0	0.5

TAPING

● Ammo

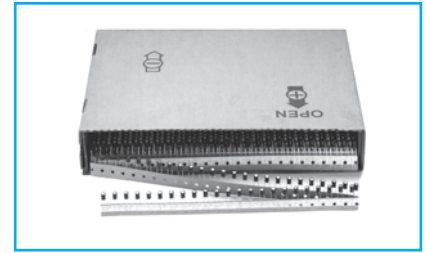

● Lead Taping Capacitors for Automatic Insertion

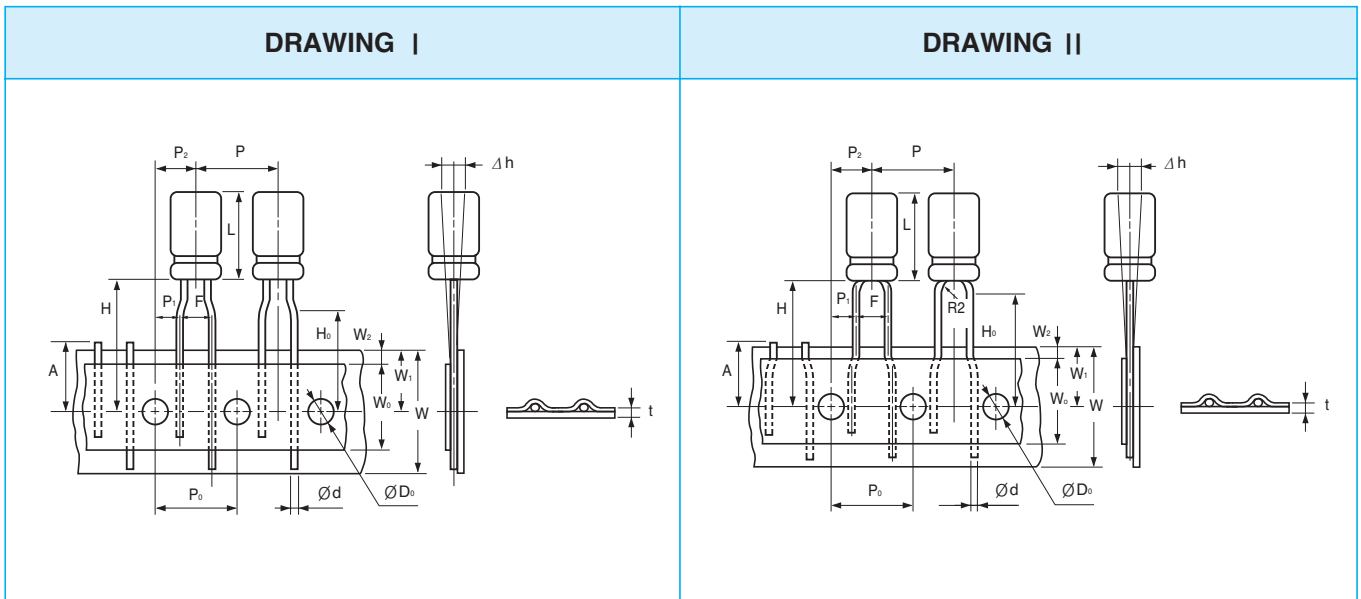

● DIMENSIONS

Unit : mm

Applicable Drawing No.			I (II)				III			I						
Description	Symbol	Tolerance	Ø3	Ø4	Ø5	Ø6.3	Ø8	Ø4	Ø5	Ø6.3	Ø8	Ø4	Ø5	Ø6.3	Ø8	
Case Height	L	*Note	5	5, 7	5	7~11	5	7~11	5	5, 7	5	7~11	5	7~11	5	9, 11.5
Lead Dia.	d	±0.05	0.4	0.45	0.45	0.5	0.45	0.5	0.45	0.45	0.45	0.5	0.45	0.5	0.45	0.6
Body Pitch	P	±1.0	12.7		12.7		12.7	12.7		12.7		12.7		12.7	12.7	
Feeding Hole Pitch	P ₀	±0.2	12.7		12.7		12.7	12.7		12.7		12.7		12.7	12.7	
Feeding Hole Alignment	P ₁	±0.7	5.1		5.1		5.1	3.85		3.85		3.85		3.85	3.85	
Feeding Hole Alignment	P ₂	±1.0	6.35		6.35		6.35	6.35		6.35		6.35		6.35	6.35	
Lead Center Spacing	F	^{+0.6} -0.2	2.5		2.5		2.5	5.0		5.0		5.0		5.0	5.0	
Body Inclination	Δh	±2.0	0		0		0	0		0		0		0	0	
Tape Width	W	±0.5	18.0		18.0		18.0	18.0		18.0		18.0		18.0	18.0	
Adhesive Tape Width	W ₀	min.	9.5		9.5		9.5	9.5		9.5		9.5		9.5	12.5	
Feeding Hole Alignment	W ₁	±0.5	9.0		9.0		9.0	9.0		9.0		9.0		9.0	9.0	
Adhesive Tape Margin	W ₂	max.	2.0		2.0		2.0	2.0		2.0		2.0		2.0	2.0	
Length from Seating Plane	H	±0.5	17.5 (18.0)		17.5		18.5	18.5 (5, 7mmL = 17.5)		17.5		20.0		17.5	20.0	
Lead Clinch Height	H ₀	±0.5	16.5 (17.0)		—		—	16.5		16.5		16.5		16.5	16.5	
Feeding Hole Dia.	ØD ₀	±0.2	4.0		4.0		4.0	4.0		4.0		4.0		4.0	4.0	
Total Tape Thickness	t	±0.2	0.7		0.7		0.7	0.7		0.7		0.7		0.7	0.7	
Cut Lead Height	A	max.	11.0		11.0		11.0	11.0		11.0		11.0		11.0	11.0	
Taping Code	Ammo	⊕ leader	PB(PC)		PC		PE	PA		PA		PA		PG	PG	

* Note : Refer to the drawing of each series for tolerance.

MINIATURE TYPES

TAPING

● Lead Taping Capacitors for Automatic Insertion

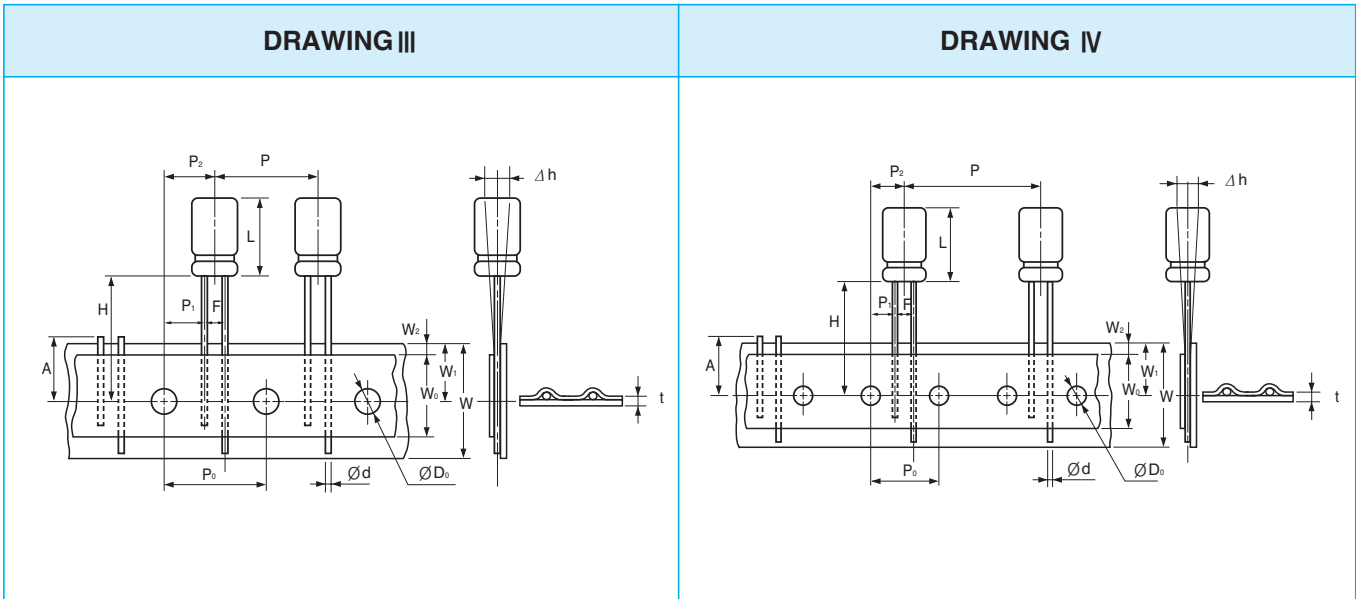

● DIMENSIONS

Unit : mm

Applicable Drawing No.			III	III	IV	IV	IV
Description	Symbol	Tolerance	Ø10	Ø12.5	Ø16	Ø18	Ø18
Case Height	L	max.	27.0	27.0	37.5	37.5	
Lead Dia.	d	±0.05	0.6	0.6	0.8	0.8	
Body Pitch	P	±1.0	12.7	15.0	25.4	30.0	30.0
Feeding Hole Pitch	P ₀	±0.2	12.7	15.0	12.7	15.0	15.0
Feeding Hole Alignment	P ₁	±0.7	3.85	5.0	3.85	3.75	3.75
Feeding Hole Alignment	P ₂	±1.0	6.35	7.5	6.35	7.5	7.5
Lead Center Spacing	F	+0.6 -0.2	5.0	5.0	7.5	7.5	
Body Inclination	Δh	±2.0	0	0	0	0	
Tape Width	W	±0.5	18.0	18.0	18.0	18.0	
Adhesive Tape Width	W ₀	min.	12.5	12.5	12.5	12.5	
Feeding Hole Alignment	W ₁	±0.5	9.0	9.0	9.0	9.0	
Adhesive Tape Margin	W ₂	max.	2.0	2.0	2.0	2.0	
Length from Seating Plane	H	±0.5	18.5	18.5	18.5	18.5	
Feeding Hole Dia.	ØD ₀	±0.2	4.0	4.0	4.0	4.0	
Total Tape Thickness	t	±0.2	0.7	0.7	0.7	0.7	
Cut Lead Height	A	max.	11.0	11.0	11.0	11.0	
Taping Code	Ammo	⊕ leader	PA	PH	PL	PA	PA

● PACKAGING Q'ty(pcs.)/Box

Unit : mm

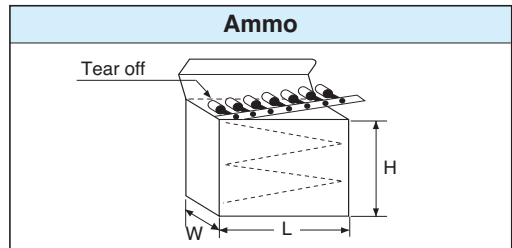

Size		Ammo			
ØD	Case Height	L	H	W	Q'ty
3	5	332	230	42	3000
4	5, 7				2500
5	5, 7	332	230	49	2000
	9, 11				
6.3	5, 7	332	230	42	1500
	9, 11				
8	5	332	230	42	1000
	9, 11.5				
10	9, 12.5, 16	332	190	51	500
	20, 25				
12.5	16, 20, 25	342	240	62	400
16	16, 20, 25	342	240	62	250
	31.5, 35.5				
18	16, 20, 25	342	240	62	200
	31.5, 35.5				

SD Standard, For General Purposes Series

- Standard series for general purposes
- High voltage, high capacitance series
- Voltage range of 6.3~500V
- Complied to the RoHS directive

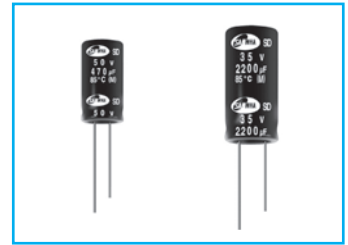

Item	Characteristics										
Operating temperature range	WV	6.3 ~ 450									
	Temperature range	-40 ~ +85°C									
Leakage current max.	WV ≤ 100	I = 0.01CV or 3μA whichever is greater (after 2 min) I = 0.03CV or 4μA whichever is greater (after 1 min)									
	WV > 100	I = 0.02CV + 15μA (after 5 min)									
Capacitance tolerance	±20% at 120Hz, 20°C										
Dissipation factor max. (at 120Hz, 20°C)	Capacitance > 1000μF : tanδ increases by 0.02 for each 1000μF from below value.										
	WV	6.3	10	16	25	35	50	63	100	160 ~ 250	350 ~ 500
tanδ	0.28	0.24	0.20	0.16	0.14	0.12	0.10	0.08	0.15	0.20	
Low temperature characteristics (Impedance ratio at 120Hz)	WV	6.3	10	16	25	35	50~100	160	200~350	400~450	500
	Z-25°C/Z+20°C	5	4	3	2	2	2	4	6	10	12
	Z-40°C/Z+20°C	12	10	8	5	4	3	6	8	12	—
Load life (after application of the rated voltage for 2000 hours at 85°C)	Leakage current	Less than specified value									
	Capacitance change	Within ±20% of initial value									
	tanδ	Less than 200% of specified value									
Shelf life (at 85°C)	After 1000 hours no load test, leakage current, capacitance and tanδ are same as load life value. The measurement shall be performed at 20°C by the KS C 6035 clause 5.4.										

DRAWING

Unit : mm

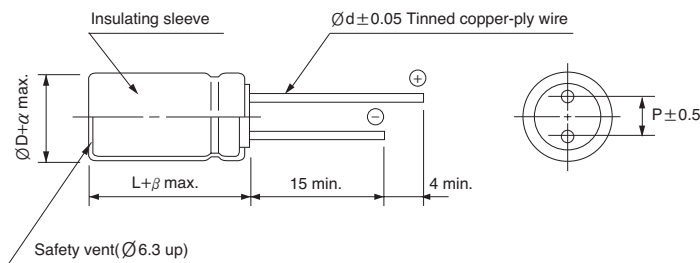

∅D	5	6.3	8	10	12.5	16	18	22	25.4
P	2.0	2.5	3.5	5.0	5.0	7.5	7.5	10.0	12.5
∅d	0.5	0.5	0.6	0.6	0.6	0.8	0.8	1.0	1.0
α	0.5								1.0
β	1.5		2.0				3.0		

FREQUENCY COEFFICIENT OF PERMISSIBLE RIPPLE CURRENT

WV	μF	Frequency	60Hz	120Hz	1kHz	10kHz	50kHz	100kHz ≤
		~ 47	0.75	1.00	1.55	2.00	2.00	2.00
6.3~100	68 ~ 680	0.80	1.00	1.35	1.50	1.62	1.75	
	1000 ~	0.85	1.00	1.15	1.15	1.32	1.50	
160~500	~ 220	0.80	1.00	1.40	1.60	1.70	1.80	
	330 ~	0.90	1.00	1.13	1.15	1.32	1.50	

MINIATURE ALUMINUM ELECTROLYTIC CAPACITORS

SD series

● DIMENSIONS & MAXIMUM PERMISSIBLE RIPPLE CURRENT

WV μF	6.3	10	16	25	35	50	63	100	160	200	250	350	400	450	500
1.0						5×11 21	5×11 23	5×11 23						8×11.5 26	
1.5						5×11 26	5×11 28	5×11 28						8×11.5 32	
2.2						5×11 32	5×11 34	5×11 34						8×11.5 33	
3.3						5×11 39	5×11 42	5×11 42	6.3×11 45	6.3×11 45	6.3×11 48	8×11.5 53	8×11.5 56	8×11.5 50	
4.7						5×11 46	5×11 50	5×11 50	6.3×11 53	6.3×11 57	6.3×11 57	8×11.5 66	10×12.5 61	10×12.5 72	10×16 69
6.8						5×11 56	5×11 60	5×11 60	8×11.5 76	8×11.5 76	8×11.5 76	10×12.5 88	10×12.5 87	10×16 86	10×16 76
10						5×11 68	5×11 72	5×11 76	8×11.5 96	8×11.5 96	10×12.5 107	10×12.5 107	10×16 115	10×20 115	12.5×25 178
15						5×11 83	5×11 89	6.3×11 89	10×12.5 131	10×16 143	10×16 143	10×20 156	12.5×20 165	12.5×20 164	
22						5×11 101	5×11 108	6.3×11 124	10×12.5 156	10×16 173	10×16 170	12.5×20 222	12.5×20 218	12.5×25 217	16×25 265
33						5×11 123	6.3×11 151	8×11.5 178	10×16 209	10×20 232	10×20 247	16×20 297	12.5×25 296	16×25 294	16×31.5 310
47					5×11 131	*6.3×11 169	6.3×11 181	8×11.5 222	10×20 293	10×20 293	12.5×20 319	16×20 353	16×25 387	16×31.5 384	18×31.5 412
68				5×11 144	*6.3×11 182	6.3×11 203	8×11.5 256	10×12.5 293	12.5×20 391	12.5×25 426	16×20 425	16×25 465	16×31.5 488	16×35.5 503	18×35.5 457
100			5×11 162	* 5×11 181	6.3×11 220	8×11.5 291	8×11.5 311	10×16 388	12.5×25 516	16×25 516	16×25 564	18×31.5 592	18×35.5 667	18×40 546	
150			* 5×11 198	6.3×11 246	8×11.5 318	10×12.5 414	10×12.5 422	10×20 528	16×20 632	16×25 691	16×31.5 726	18×40 845	18×40 863	22×45 1283	
220	5×11 201	* 5×11 218	6.3×11 276	6.3×11 327	8×11.5 386	10×12.5 501	10×16 586	12.5×20 737	16×25 873	18×31.5 962	18×35.5 988	22×41 1112	22×45 1183		
330	*6.3×11 283	6.3×11 307	6.3×11 359	8×11.5 431	10×12.5 549	10×16 672	10×20 784	12.5×25 1002	16×35.5 1152	18×35.5 1206	22×41 1495				
470	6.3×11 338	6.3×11 366	8×11.5 476	10×12.5 550	10×16 740	10×20 875	12.5×20 1098	16×25 1328	18×40 1434	22×41 1495	25.4×41 1612				
680	8×11.5 480	8×11.5 520	8×11.5 600	10×16 754	10×20 947	12.5×20 1235	12.5×25 1440	16×31.5 1643	22×41 1831	25.4×51 1902	25.4×51 2151				
1000	8×11.5 581	10×12.5 659	10×12.5 796	10×16 942	12.5×20 1306	12.5×25 1633	16×25 1937	18×31.5 1965	25.4×51 2105						
2200	10×16 983	10×16 1051	10×20 1331	12.5×20 1542	16×25 2032	16×31.5 2220	18×31.5 2445	25.4×41 2612							
3300	10×20 1286	12.5×20 1545	12.5×20 1686	16×25 2194	16×31.5 2502	18×31.5 2765	18×40 2987								
4700	12.5×20 1736	12.5×25 1903	12.5×25 2129	16×25 2448	16×35.5 2905	18×40 3272	25.4×41 3412								
6800	12.5×25 2129	16×25 2332	16×25 2577	18×31.5 3114	18×40 3408	25.4×41 4251	25.4×51 4351	← Case size ØD×L (mm) ← Ripple current (mA rms) at 85°C, 120Hz							
10000	16×25 2629	16×31.5 2830	16×31.5 3176	18×40 3544	25.4×41 3899										
15000	16×35.5 2959	16×35.5 3284	18×35.5 3656	25.4×41 4399											
22000	18×40 3733	18×40 3843	22×41 4012												

Size Ø8×9 is available for capacitors marked "★"

SD series

TYPICAL PERFORMANCE

— 16V 1000 μ F
 400V 10 μ F

● TEMPERATURE CHARACTERISTICS

Capacitance change vs. temperature

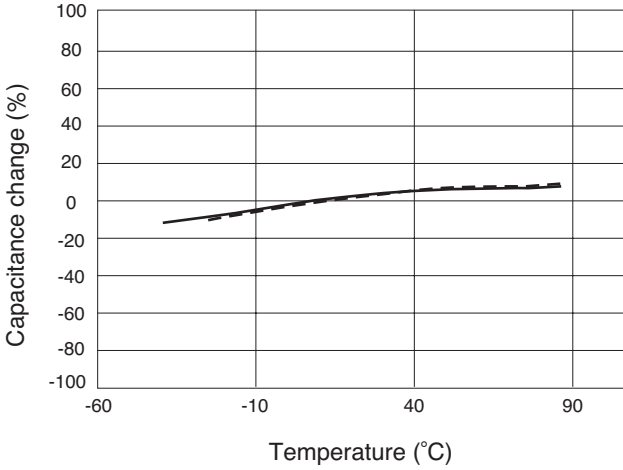

● LOAD LIFE (at +85°C)

Capacitance change vs. time

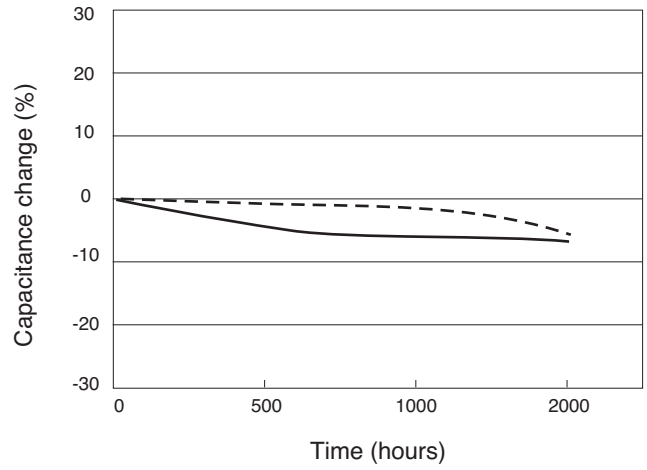

Dissipation factor vs. temperature

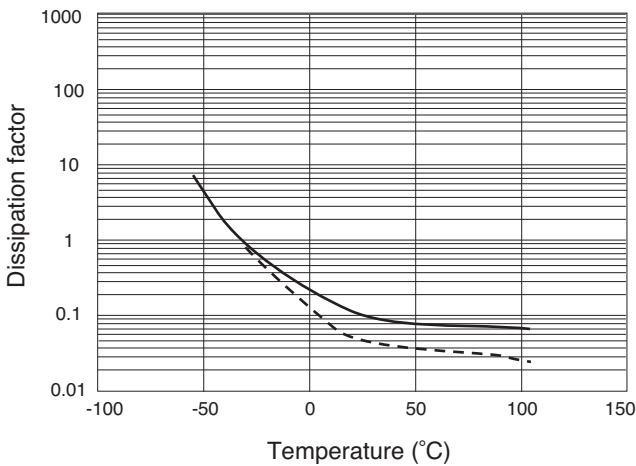

Dissipation factor vs. time

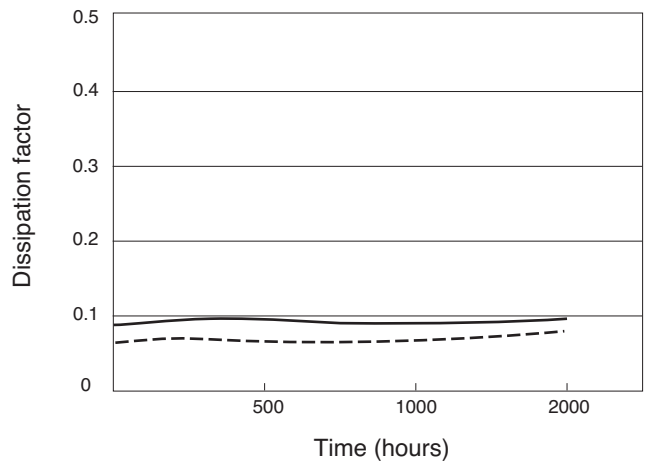

● FREQUENCY CHARACTERISTICS

Impedance vs. frequency

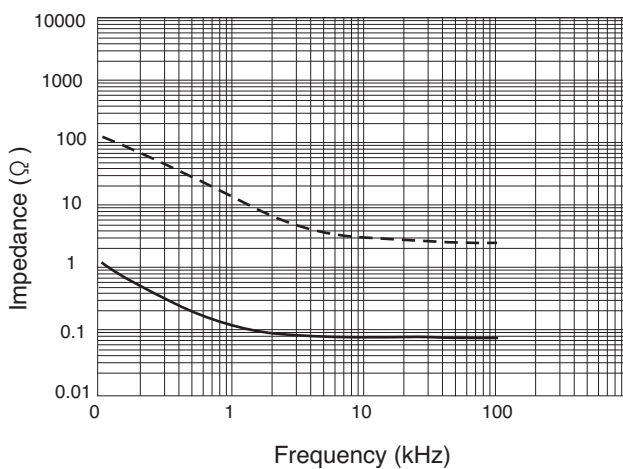

Leakage current vs. time

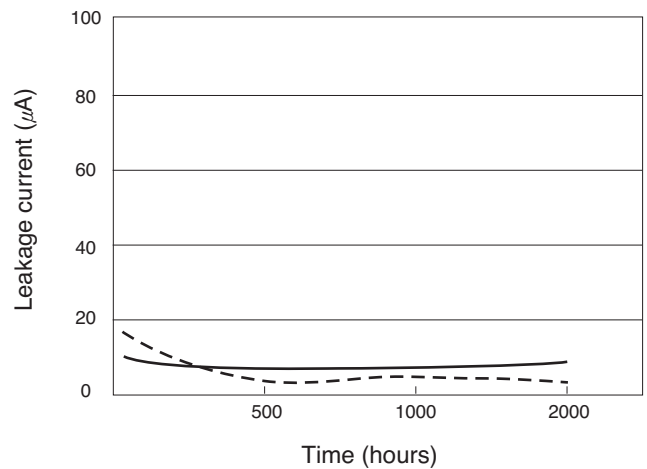

MINIATURE TYPES

MINIATURE ALUMINUM ELECTROLYTIC CAPACITORS

SS Standard, Height 7mmL Series

- Super miniature series with 7mmL height
- Suited for use in compact audio equipment
- Load life of 2000 hours at 85°C
- Complied to the RoHS directive

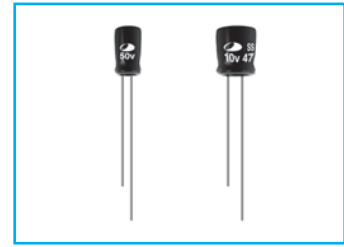
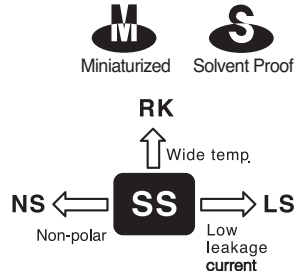

Item	Characteristics									
Operating temperature range	-40 ~ +85°C									
Leakage current max.	I = 0.01CV or 4μA whichever is greater (after 1 minute)									
Capacitance tolerance	±20% at 120Hz, 20°C									
Dissipation factor max. (at 120Hz, 20°C)	WV	4	6.3	10	16	25	35, 40	50	63	
	tanδ	0.35	0.24	0.20	0.16	0.14	0.12	0.10	0.10	
Low temperature characteristics (Impedance ratio at 120Hz)	WV	4	6.3	10	16, 25		35 ~ 63			
	Z-25°C/Z+20°C	6	4	3	2		2			
	Z-40°C/Z+20°C	12	8	6	4		3			
Load life (after application of the rated voltage for 2000 hours at 85°C)	Leakage current	Less than specified value								
	Capacitance change	Within ±20% of initial value								
	tanδ	Less than 200% of specified value								
Shelf life (at 85°C)	After 1000 hours no load test, leakage current, capacitance and tanδ are same as load life value. The measurement shall be performed at 20°C by the KS C 6035 clause 5.4.									

● DRAWING (See page 97)

Unit : mm

● DIMENSIONS & MAXIMUM PERMISSIBLE RIPPLE CURRENT

μF \ WV	4	6.3	10	16	25	35	40	50	63
0.1								4×7 4.4	4×7 4.4
0.15								4×7 5.4	4×7 5.4
0.22								4×7 6.6	4×7 6.6
0.33								4×7 8.0	4×7 8.0
0.47								4×7 10	4×7 10
0.68								4×7 12	4×7 12
1.0								4×7 14	4×7 14
1.5								4×7 17	4×7 17
2.2								4×7 21	4×7 21
3.3								4×7 25	4×7 25
4.7								4×7 30	4×7 30
6.8						4×7 33	4×7 33	4×7 37	5×7 42
10					4×7 37	4×7 40	4×7 40	5×7 51	5×7 51
15				4×7 43	4×7 46	5×7 57	5×7 57	6.3×7 72	6.3×7 72
22			4×7 46	4×7 52	5×7 64	5×7 69	6.3×7 80	6.3×7 88	
33	4×7 43	4×7 52	4×7 57	5×7 73	5×7 78	6.3×7 98	6.3×7 98		
47	4×7 51	4×7 62	5×7 78	5×7 87	6.3×7 108				
68	5×7 71	5×7 86	5×7 94	6.3×7 122					
100	5×7 86	5×7 104	6.3×7 132	6.3×7 148					
150	6.3×7 122	6.3×7 148	6.3×7 162						
220	6.3×7 148	6.3×7 179							

— Ripple current (mA rms) at 85°C, 120Hz
 — Case size ØD×L (mm)

● FREQUENCY COEFFICIENT OF PERMISSIBLE RIPPLE CURRENT

μF \ Frequency	60Hz	120Hz	1kHz	10kHz	50kHz	100kHz ≤
~ 47	0.75	1.00	1.55	2.00	2.00	2.00
68 ~ 680	0.80	1.00	1.35	1.50	1.62	1.75

MINIATURE ALUMINUM ELECTROLYTIC CAPACITORS



SE Standard, Height 5mmL Series

- Ultra miniature series with 5mmL height
- Suitable to replace tantalum capacitors at low cost
- Load life of 2000 hours at 85°C
- Complied to the RoHS directive

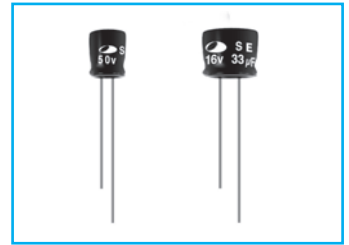
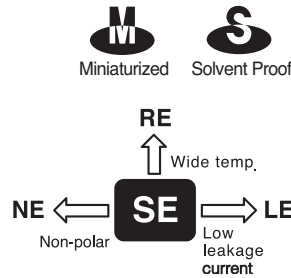

Item	Characteristics																		
Operating temperature range	-40 ~ +85°C																		
Leakage current max.	$I = 0.01CV$ or $4\mu A$ whichever is greater (after 1 minute)																		
Capacitance tolerance	$\pm 20\%$ at 120Hz, 20°C																		
Dissipation factor max. (at 120Hz, 20°C)	<table border="1"> <thead> <tr> <th>WV</th> <th>4</th> <th>6.3</th> <th>10</th> <th>16</th> <th>25</th> <th>35</th> <th>50</th> <th>63</th> </tr> </thead> <tbody> <tr> <td>$\tan\delta$</td> <td>0.35</td> <td>0.24</td> <td>0.20</td> <td>0.16(0.20)</td> <td>0.13(0.15)</td> <td>0.12(0.14)</td> <td>0.09(0.11)</td> <td>0.09(0.11)</td> </tr> </tbody> </table>	WV	4	6.3	10	16	25	35	50	63	$\tan\delta$	0.35	0.24	0.20	0.16(0.20)	0.13(0.15)	0.12(0.14)	0.09(0.11)	0.09(0.11)
	WV	4	6.3	10	16	25	35	50	63										
$\tan\delta$	0.35	0.24	0.20	0.16(0.20)	0.13(0.15)	0.12(0.14)	0.09(0.11)	0.09(0.11)											
Figures in () are for $\varnothing 3$ products.																			
Low temperature characteristics (Impedance ratio at 120Hz)	<table border="1"> <thead> <tr> <th>WV</th> <th>4</th> <th>6.3</th> <th>10</th> <th>16 ~ 63</th> </tr> </thead> <tbody> <tr> <td>Z-25°C/Z+20°C</td> <td>6</td> <td>4</td> <td>3</td> <td>2</td> </tr> <tr> <td>Z-40°C/Z+20°C</td> <td>12</td> <td>8</td> <td>6</td> <td>4</td> </tr> </tbody> </table>	WV	4	6.3	10	16 ~ 63	Z-25°C/Z+20°C	6	4	3	2	Z-40°C/Z+20°C	12	8	6	4			
	WV	4	6.3	10	16 ~ 63														
	Z-25°C/Z+20°C	6	4	3	2														
Z-40°C/Z+20°C	12	8	6	4															
Load life (after application of the rated voltage for 2000 hours at 85°C)	Leakage current	Less than specified value																	
	Capacitance change	Within $\pm 20\%$ of initial value																	
	$\tan\delta$	Less than 200% of specified value																	
Shelf life (at 85°C)	After 1000 hours no load test, leakage current, capacitance and $\tan\delta$ are same as load life value. The measurement shall be performed at 20°C by the KS C 6035 clause 5.4.																		

● DRAWING (See page 98)

Unit : mm

● DIMENSIONS & MAXIMUM PERMISSIBLE RIPPLE CURRENT

μF \ WV	4	6.3	10	16	25	35	50	63
0.1							4×5(3×5)	4.1(3.1)
0.15							4×5(3×5)	5.0(3.8)
0.22							4×5(3×5)	6.1(4.6)
0.33							4×5(3×5)	7.5(5.7)
0.47							4×5(3×5)	8.9(6.7)
0.68							4×5(3×5)	11(8.1)
1.0							4×5(3×5)	13(9.8)
1.5							4×5(3×5)	16(12)
2.2						4×5(3×5)	17(13)	4×5
3.3					4×5(3×5)	20(15)	4×5	20
4.7				4×5(3×5)	21(16)	4×5	23	4×5
6.8			4×5(3×5)	23(19)	4×5	25	4×5	28
10	4×5(3×5)	21(17)	4×5(3×5)	25(21)	4×5	28	4×5	31
15	4×5(3×5)	26(21)	4×5	31	4×5	34	5×5	44
22	4×5(3×5)	31(26)	4×5	37	5×5	47	5×5	53
33	4×5	38	5×5	53	5×5	58	6.3×5	76
47	4×5	45	5×5	63	6.3×5	81	6.3×5	91
68	5×5	63	6.3×5	89	6.3×5	98	6.3×5	109
100	5×5	89	6.3×5	108	8×5	140	8×5	157
150	6.3×5	109	8×5	157	8×5	172	8×5	192
220	6.3×5	133	8×5	190	8×5	208		
330	8×5	192						

Ripple current (mA rms) at 85°C, 120Hz
Case size $\varnothing D \times L$ (mm)

● FREQUENCY COEFFICIENT OF PERMISSIBLE RIPPLE CURRENT

μF \ Frequency	60Hz	120Hz	1kHz	10kHz	50kHz	100kHz \leq
~ 47	0.75	1.00	1.55	2.00	2.00	2.00
68 ~	0.80	1.00	1.35	1.50	1.62	1.75

MINIATURE ALUMINUM ELECTROLYTIC CAPACITORS

RD Wide Temperature Range Series

- Standard series for general purpose
- High CV value
- Wide operating temperature range of -55 ~ +105°C
- Complied to the RoHS directive

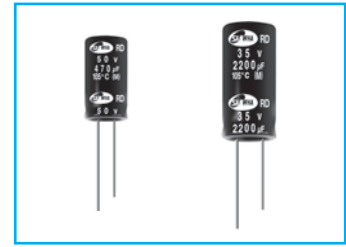
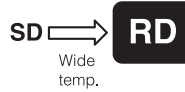

Item	Characteristics										
Operating temperature range	WV	6.3 ~ 100			160 ~ 450			500			
	Temperature range	-55 ~ +105°C			-40 ~ +105°C			-25 ~ +105°C			
Leakage current max.	WV ≤ 100						WV > 100				
	I = 0.01CV or 3μA whichever is greater (after 2 min) I = 0.03CV or 4μA whichever is greater (after 1 min)						I = 0.02CV+15μA (after 5 min)				
Capacitance tolerance	±20% at 120Hz, 20°C										
Dissipation factor max. (at 120Hz, 20°C)	Capacitance > 1000μF : tanδ increases by 0.02 for each 1000μF from below value.										
	WV	6.3	10	16	25	35	50	63	100	160~250	350~500
tanδ	0.28	0.24	0.20	0.16	0.14	0.12	0.10	0.08	0.15	0.20	
Low temperature characteristics (Impedance ratio at 120Hz)	WV	6.3	10	16	25	35	50~100	160	200~350	400~450	500
	Z-25°C/Z+20°C	5	4	3	2	2	2	4	6	10	12
	Z-40°C/Z+20°C	12	10	8	5	4	3	6	8	12	—
Load life (after application of the rated voltage for 2000 hours at 105°C)	Leakage current		Less than specified value								
	Capacitance change		Within ±20% of initial value								
	tanδ		Less than 200% of specified value								
	∅D		∅D ≤ 8			∅D ≥ 10					
Life time		1000 hours			2000 hours						
Shelf life (at 105°C)	After 1000 hours no load test, leakage current, capacitance and tanδ are same as load life value. The measurement shall be performed at 20°C by the KS C 6035 clause 5.4.										

DRAWING

Unit : mm

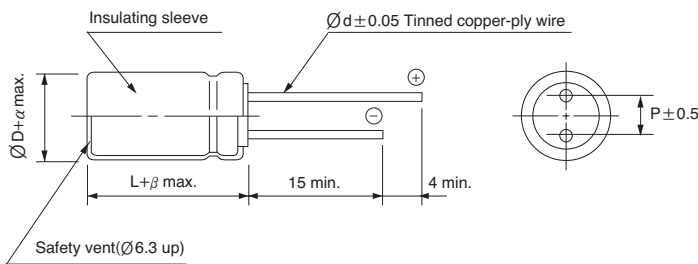

∅D	5	6.3	8	10	12.5	16	18	22
P	2.0	2.5	3.5	5.0	5.0	7.5	7.5	10.0
∅d	0.5	0.5	0.6	0.6	0.6	0.8	0.8	1.0
α	0.5							1.0
β	1.5		2.0				3.0	

FREQUENCY COEFFICIENT OF PERMISSIBLE RIPPLE CURRENT

WV	μF	Frequency	60Hz	120Hz	1kHz	10kHz	50kHz	100kHz ≤
			~ 47	0.75	1.00	1.55	2.00	2.00
6.3~100	68 ~ 680	0.80	1.00	1.35	1.50	1.62	1.75	
	820 ~	0.85	1.00	1.15	1.15	1.32	1.50	
160~500	~ 220	0.80	1.00	1.40	1.60	1.70	1.80	
	330 ~	0.90	1.00	1.13	1.15	1.32	1.50	

● DIMENSIONS & MAXIMUM PERMISSIBLE RIPPLE CURRENT

WV μF	WV														
	6.3	10	16	25	35	50	63	100	160	200	250	350	400	450	500
2.2						5×11 24	5×11 26	5×11 26	6.3×11 23	6.3×11 23	6.3×11 23	8×11.5 28	8×11.5 28	10×12.5 27	
3.3						5×11 29	5×11 32	5×11 32	6.3×11 29	6.3×11 29	8×11.5 34	8×11.5 34	10×12.5 39	10×16 36	
4.7						5×11 35	5×11 38	5×11 38	6.3×11 34	8×11.5 40	8×11.5 40	10×12.5 47	10×12.5 47	10×16 43	10×16 59
6.8						5×11 42	5×11 46	5×11 46	8×11.5 49	10×12.5 56	10×12.5 56	10×16 62	10×16 62	10×20 56	10×16 72
10						5×11 51	5×11 56	5×11 56	10×12.5 68	10×12.5 68	10×12.5 68	10×16 75	10×20 82	12.5×20 80	12.5×20 88
15						5×11 62	5×11 68	6.3×11 78	10×16 92	10×16 92	10×16 92	10×20 100	12.5×20 118	12.5×25 107	12.5×30 115
22						5×11 75	5×11 83	6.3×11 95	10×16 111	10×16 111	10×20 121	12.5×20 143	12.5×25 155	16×25 144	16×25 159
33						5×11 92	6.3×11 116	8×11.5 137	10×20 149	10×20 149	12.5×20 175	12.5×25 190	16×25 211	16×31.5 193	16×31.5 207
47					★ 5×11 96	★ 6.3×11 127	6.3×11 139	10×12.5 190	12.5×20 208	12.5×20 208	12.5×25 227	16×25 252	16×31.5 276	16×31.5 230	18×31.5 261
68				★ 5×11 108	6.3×11 132	8×11.5 180	8×11.5 197	10×16 251	12.5×25 273	16×20 279	16×25 303	16×31.5 332	18×35.5 373	18×31.5 285	18×35.5 335
82				6.3×11 137	6.3×11 145	8×11.5 198	8×11.5 216	10×20 290	12.5×25 302	16×25 333	16×31.5 364	18×35.5 369	18×40 387	18×31.5 327	18×40 370
100			5×11 119	6.3×11 151	6.3×11 160	8×11.5 218	8×11.5 239	10×20 332	12.5×25 331	16×25 368	16×31.5 402	18×35.5 407	18×40 427	18×40 486	
150		5×11 134	★ 6.3×11 167	6.3×11 185	8×11.5 231	10×12.5 310	10×12.5 340	12.5×20 477	16×25 450	16×35.5 517	18×35.5 554	18×40 523	22×41 596		
220	5×11 146	★ 5×11 162	6.3×11 203	8×11.5 264	8×11.5 280	10×12.5 376	10×16 451	12.5×25 630	16×31.5 596	18×35.5 671	18×40 694	22×41 721			
330	★ 6.3×11 206	6.3×11 228	8×11.5 293	8×11.5 324	10×12.5 399	10×16 504	10×20 603	16×25 856	18×35.5 822	18×40 850	22×41 968				
470	6.3×11 246	6.3×11 272	8×11.5 349	10×12.5 449	10×16 521	10×20 657	12.5×20 844	16×25 1021	18×40 1015	22×41 1155					
680	8×11.5 348	10×12.5 449	10×12.5 488	10×16 591	12.5×16 740	12.5×20 927	12.5×25 1107	16×31.5 1344	22×41 1390						
820	8×11.5 382	10×12.5 493	10×16 587	10×20 708	12.5×20 880	12.5×25 1050	16×25 1300	16×35.5 1627							
1000	8×11.5 422	10×12.5 544	10×16 648	10×20 820	12.5×20 974	12.5×25 1226	16×25 1490	18×40 1925							
1500	10×16 621	10×16 680	12.5×16 862	12.5×20 1017	16×20 1188	16×25 1442	16×35.5 1770								
2200	10×20 778	10×20 844	12.5×20 1055	12.5×20 1100	16×25	16×31.5	16×35.5								
				12.5×25 1235	1426	1442	1770								
3300	12.5×16 983	12.5×20 1148	12.5×25 1323	16×25 1562	16×35.5 1857	16×35.5 1794	18×40 2689								
4700	12.5×20 1219	12.5×25 1421	16×25 1657	16×31.5 1916	18×35.5 2224	← Case size ØD×L (mm)									
6800	12.5×25 1480	16×25 1737	16×31.5 1982	18×35.5 2335											
10000	16×25 1807	16×35.5 2172	18×35.5 2409												
15000	16×35.5 2233	18×35.5 2482													
22000	18×40 2652														

Size Ø8×9 is available for capacitors marked "★"

MINIATURE TYPES

MINIATURE ALUMINUM ELECTROLYTIC CAPACITORS

RD series

TYPICAL PERFORMANCE

— 16V 1000 μ F
 400V 10 μ F

● TEMPERATURE CHARACTERISTICS

Capacitance change vs. temperature

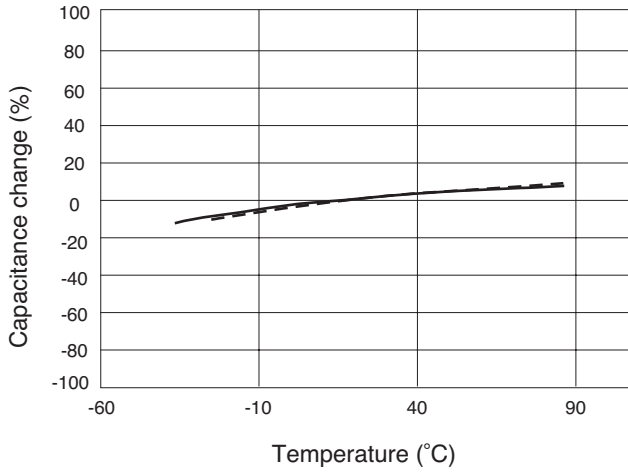

● LOAD LIFE (at +105°C)

Capacitance change vs. time

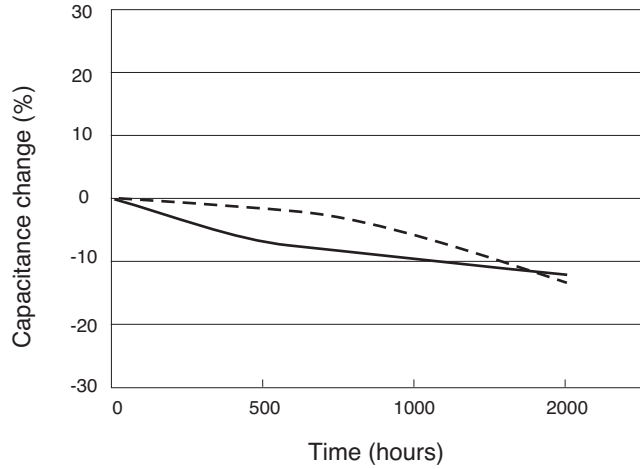

Dissipation factor vs. temperature

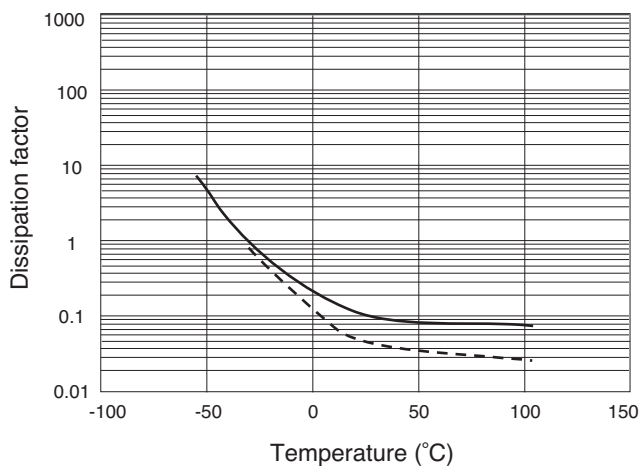

Dissipation factor vs. time

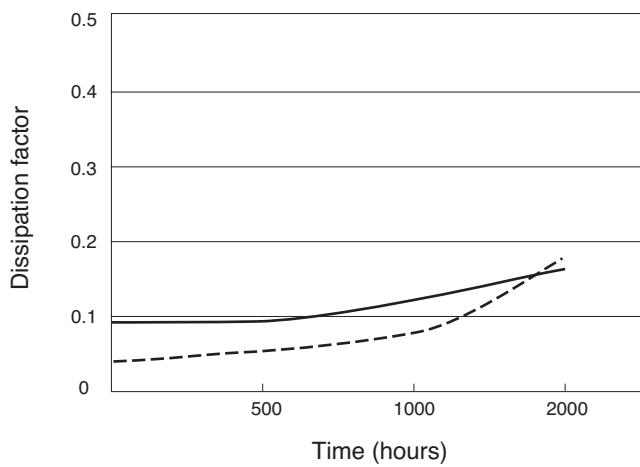

● FREQUENCY CHARACTERISTICS

Impedance vs. frequency

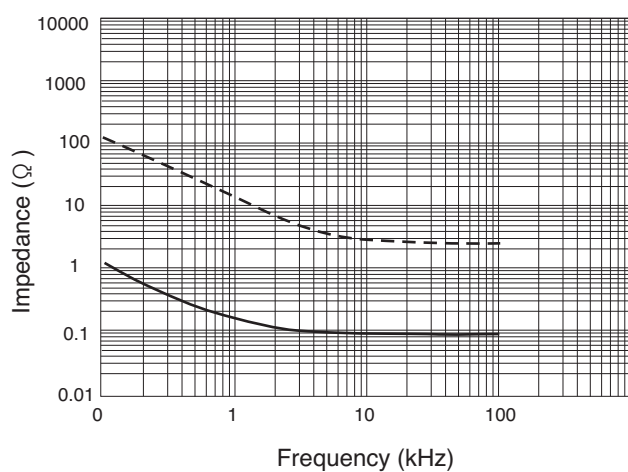

Leakage current vs. time

