

本公司智慧財產，未經同意不得複製
 Diptronics copyright,
 may not be used without permission from Diptronics.

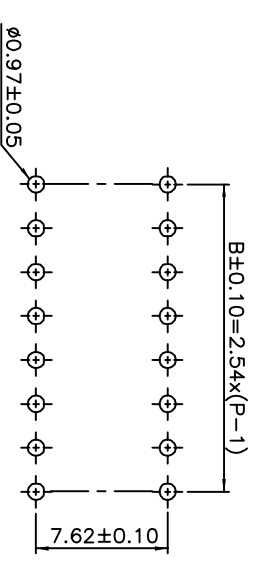

NDP -12V	12	32.04	27.94
NDPL-12V			
NDP -10V	10	26.96	22.86
NDPL-10V			
NDP -09V	9	24.42	20.32
NDPL-09V			
NDP -08V	8	21.88	17.78
NDPL-08V			
NDP -07V	7	19.34	15.24
NDPL-07V			
NDP -06V	6	16.80	12.70
NDPL-06V			
NDP -05V	5	14.26	10.16
NDPL-05V			
NDP -04V	4	11.72	7.62
NDPL-04V			
NDP -03V	3	9.18	5.08
NDPL-03V			
NDP -02V	2	6.64	2.54
NDPL-02V			
PROD. NO.	NO. OF POS.	DIM. A	DIM. B

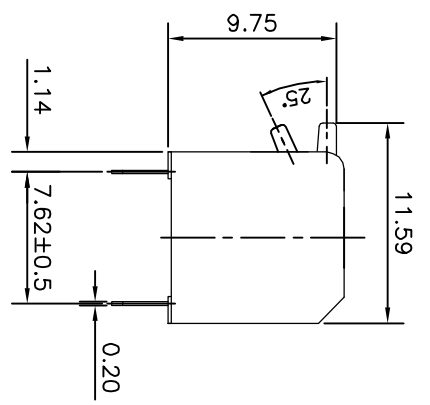
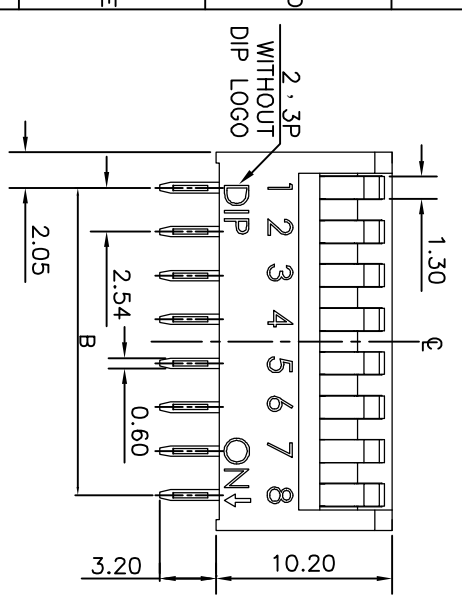
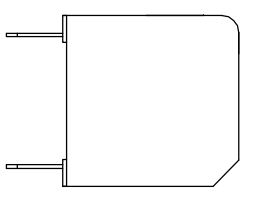
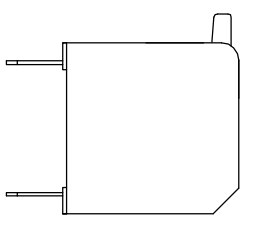
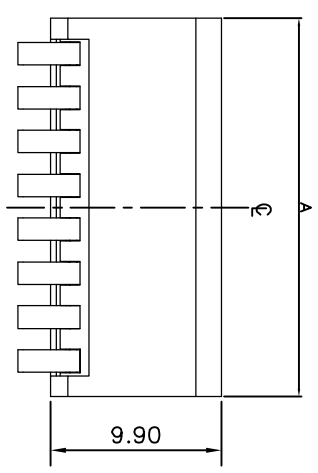
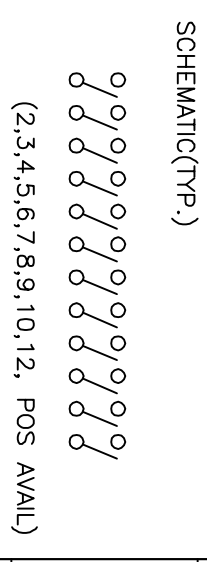

NOTE: 1. ALL DIMENSIONS ARE IN MILLIMETERS.
 2. GENERAL TOLERANCES ±0.2mm



△			
△			
△			
△	A	DWG.REL	06.14.16
△		DESCRIPTION	DATE
△			APP'U.

APP'D:	DATE:	PART NO:	PART NAME:
CHKD:	SCALE:	NDP-0000V	PIANO TYPE DIP SWITCH
DR:Michelle	5:1		
06.14.16	UNITS: mm		
REV: A		FINISH:	DWG NO: RD2P1
DESIGN: LARRY			