

## TLV27x Family of 550- $\mu$ A/Ch, 3-MHz, Rail-to-Rail Output Operational Amplifiers

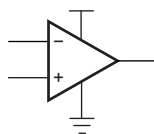
### 1 Features

- Rail-to-Rail Output
- Wide Bandwidth: 3 MHz
- High Slew Rate: 2.4 V/ $\mu$ s
- Supply Voltage Range: 2.7 V to 16 V
- Supply Current: 550  $\mu$ A/Channel
- Input Noise Voltage: 39 nV/ $\sqrt{\text{Hz}}$
- Input Bias Current: 1 pA
- Specified Temperature Range:
  - Commercial Grade: 0°C to 70°C
  - Industrial Grade: -40°C to 125°C
- Ultrasmall Packaging:
  - 5-Pin SOT-23 (TLV271)
  - 8-Pin MSOP (TLV272)
- Ideal Upgrade for TLC72x Family

### 2 Applications

- E-Bike
- Power Banks
- Smoke detectors
- Solar Inverters
- Low-Power Motor Controls
- Battery-Powered Instruments
- Building Automation

#### Operational Amplifier



Copyright © 2016,  
Texas Instruments Incorporated

### 3 Description

Operating from 2.7 V to 16 V over the extended industrial temperature range from -40°C to +125°C, the TLV27x is a low power, wide bandwidth operational amplifier (opamp) with rail to rail output. This makes it an ideal alternative to the TLC27x family for applications where rail-to-rail output swings are essential. The TLV27x provides 3-MHz bandwidth from only 550  $\mu$ A.

Like the TLC27x, the TLV27x is fully specified for 5-V and  $\pm$ 5-V supplies. The maximum recommended supply voltage is 16 V, which allows the devices to be operated from a variety of rechargeable cells ( $\pm$ 8 V supplies down to  $\pm$ 1.35 V).

The CMOS inputs enable use in high-impedance sensor interfaces, with the lower voltage operation making an attractive alternative for the TLC27x in battery-powered applications.

All members are available in PDIP and SOIC with the singles in the small SOT-23 package, duals in the MSOP, and quads in the TSSOP package.

The 2.7-V operation makes it compatible with Li-Ion powered systems and the operating supply voltage range of many micropower microcontrollers available today including TI's [MSP430](#).

#### Device Information<sup>(1)</sup>

PART NUMBER	PACKAGE	BODY SIZE (NOM)
TLV271	SOIC (8)	4.98 mm x 3.91 mm
	SOT-23 (5)	2.90 mm x 1.60 mm
	PDIP (8)	9.81 mm x 6.35 mm
TLV272	SOIC (8)	4.98 mm x 3.91 mm
	PDIP (8)	9.81 mm x 6.35 mm
	VSSOP (8)	3.00 mm x 3.00 mm
TLV274	SOIC (14)	8.65 mm x 3.91 mm
	PDIP (14)	3.90 mm x 6.35 mm
	TSSOP (14)	5.00 mm x 4.40 mm

(1) For all available packages, see the orderable addendum at the end of the data sheet.



## Table of Contents

<b>1 Features</b> .....	<b>1</b>	8.1 Overview .....	<b>16</b>
<b>2 Applications</b> .....	<b>1</b>	8.2 Functional Block Diagram .....	<b>16</b>
<b>3 Description</b> .....	<b>1</b>	8.3 Feature Description .....	<b>17</b>
<b>4 Revision History</b> .....	<b>2</b>	8.4 Device Functional Modes .....	<b>17</b>
<b>5 Device Comparison Table</b> .....	<b>3</b>	<b>9 Application and Implementation</b> .....	<b>18</b>
<b>6 Pin Configuration and Functions</b> .....	<b>4</b>	9.1 Application Information .....	<b>18</b>
<b>7 Specifications</b> .....	<b>6</b>	9.2 Typical Application .....	<b>18</b>
7.1 Absolute Maximum Ratings .....	<b>6</b>	9.3 System Examples .....	<b>19</b>
7.2 Recommended Operating Conditions .....	<b>6</b>	<b>10 Power Supply Recommendations</b> .....	<b>21</b>
7.3 Thermal Information: TLV271 .....	<b>7</b>	<b>11 Layout</b> .....	<b>21</b>
7.4 Thermal Information: TLV272 .....	<b>7</b>	11.1 Layout Guidelines .....	<b>21</b>
7.5 Thermal Information: TLV274 .....	<b>7</b>	11.2 Layout Example .....	<b>22</b>
7.6 Electrical Characteristics: DC Characteristics .....	<b>8</b>	<b>12 Device and Documentation Support</b> .....	<b>23</b>
7.7 Electrical Characteristics: Input Characteristics .....	<b>8</b>	12.1 Documentation Support .....	<b>23</b>
7.8 Electrical Characteristics: Output Characteristics .....	<b>9</b>	12.2 Related Links .....	<b>23</b>
7.9 Electrical Characteristics: Power Supply .....	<b>10</b>	12.3 Receiving Notification of Documentation Updates .....	<b>23</b>
7.10 Electrical Characteristics: Dynamic Performance .....	<b>10</b>	12.4 Community Resource .....	<b>23</b>
7.11 Electrical Characteristics: Noise/Distortion Performance .....	<b>10</b>	12.5 Trademarks .....	<b>23</b>
7.12 Typical Characteristics .....	<b>11</b>	12.6 Electrostatic Discharge Caution .....	<b>23</b>
<b>8 Detailed Description</b> .....	<b>16</b>	12.7 Glossary .....	<b>24</b>
		<b>13 Mechanical, Packaging, and Orderable Information</b> .....	<b>24</b>

## 4 Revision History

NOTE: Page numbers for previous revisions may differ from page numbers in the current version.

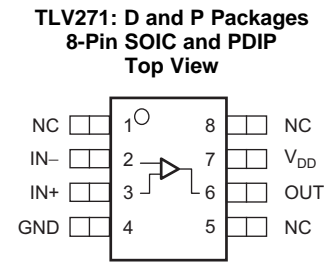
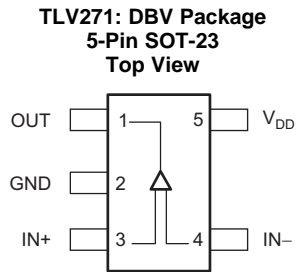
<b>Changes from Revision D (February 2004) to Revision E</b>	<b>Page</b>
• Added <i>Feature Description</i> section, <i>Device Functional Modes</i> , <i>Application and Implementation</i> section, <i>Power Supply Recommendations</i> section, <i>Layout</i> section, <i>Device and Documentation Support</i> section, and <i>Mechanical, Packaging, and Orderable Information</i> section .....	<b>1</b>
• Deleted <i>Continuous total power dissipation</i> parameter from <i>Absolute Maximum Ratings</i> .....	<b>6</b>
• Deleted <i>Dissipation Ratings</i> table .....	<b>7</b>
• Deleted <i>Macromodel Information</i> .....	<b>21</b>

## 5 Device Comparison Table

DEVICE <sup>(1)</sup>	V <sub>DD</sub> (V)	V <sub>IO</sub> (μV)	I <sub>Q</sub> /Ch (μA)	I <sub>B</sub> (pA)	GBW (MHz)	SR (V/μs)	SHUTDOWN	RAIL-TO-RAIL	SINGLES/ DUALS/ QUADS
TLV27x	2.7 to 16	500	550	1	3	2.4	—	O	S/D/Q
TLC27x	3 to 16	1100	675	1	1.7	3.6	—	—	S/D/Q
TLV237x	2.7 to 16	500	550	1	3	2.4	Yes	I/O	S/D/Q
TLC227x	2.7 to 16	300	1100	1	2.2	3.6	—	O	D/Q
TLV246x	2.7 to 6	150	550	1300	6.4	1.6	Yes	I/O	S/D/Q
TLV247x	2.7 to 6	250	600	2	2.8	1.5	Yes	I/O	S/D/Q
TLV244x	2.7 to 10	300	725	1	1.8	1.4	—	O	D/Q

(1) Typical values measured at 5 V, 25°C.

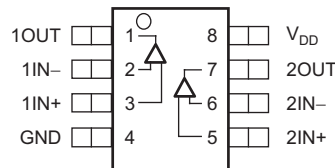
## 6 Pin Configuration and Functions



### Pin Functions

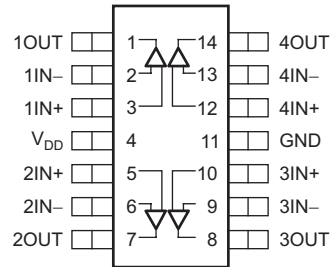
NAME	PIN		I/O	DESCRIPTION
	TLV271 SOT-23	TLV271 SOIC PDIP		
GND	2	4	—	Negative (lowest) supply or ground (for single-supply operation)
IN-	4	2	I	Negative (inverting) input
IN+	3	3	I	Positive (noninverting) input
NC	—	1, 5, 8	—	No internal connection (can be left floating)
OUT	1	6	O	Output
V <sub>DD</sub>	5	7	—	Positive (highest) supply

**TLV272: D, DGK, and P Packages  
8-Pin SOIC, VSSOP, and PDIP  
Top View**



### Pin Functions

NAME	PIN		I/O	DESCRIPTION
	TLV272 SOIC VSSOP PDIP	TLV272		
GND	4	—	—	Negative (lowest) supply or ground (for single-supply operation)
1IN-	2	I	I	Inverting input, channel 1
1IN+	3	I	I	Noninverting input, channel 1
2IN-	6	I	I	Inverting input, channel 2
2IN+	5	I	I	Noninverting input, channel 2
1OUT	1	O	O	Output, channel 1
2OUT	7	O	O	Output, channel 2
V <sub>DD</sub>	8	—	—	Positive (highest) supply

**TLV274: D, PW, and N Packages  
14-Pin SOIC, TSSOP, and PDIP  
Top View**

**Pin Functions**

PIN		I/O	DESCRIPTION
NAME	TLV274 SOIC TSSOP PDIP		
GND	11	—	Negative supply or ground (for single-supply operation)
1IN–	2	I	Inverting input, channel 1
1IN+	3	I	Noninverting input, channel 1
2IN–	6	I	Inverting input, channel 2
2IN+	5	I	Noninverting input, channel 2
3IN–	9	I	Inverting input, channel 3
3IN+	10	I	Noninverting input, channel 3
4IN–	13	I	Inverting input, channel 4
4IN+	12	I	Noninverting input, channel 4
1OUT	1	O	Output, channel 1
2OUT	7	O	Output, channel 2
3OUT	8	O	Output, channel 3
4OUT	14	O	Output, channel 4
V <sub>DD</sub>	4	—	Positive supply

## 7 Specifications

### 7.1 Absolute Maximum Ratings

over operating free-air temperature range (unless otherwise noted)<sup>(1)</sup>

		MIN	MAX	UNIT	
Voltage	Supply, $V_{DD}$		16.5	V	
	Differential input, $V_{ID}$	$-V_{DD}$	$V_{DD}$	V	
	Input, $V_I$	-0.2	$V_{DD} + 0.2$	V	
Current	Input, $I_I$	-10	10	mA	
	Output, $I_O$	-100	100	mA	
Temperature	Operating, $T_A$	C-suffix	0	70	°C
		I-suffix	-40	125	°C
	Junction, $T_J$		150	°C	
	Storage, $T_{stg}$	-65	150	°C	

(1) Stresses beyond those listed under *Absolute Maximum Ratings* may cause permanent damage to the device. These are stress ratings only, which do not imply functional operation of the device at these or any other conditions beyond those indicated under *Recommended Operating Conditions*. Exposure to absolute-maximum-rated conditions for extended periods may affect device reliability. All voltage values, except differential voltages, are with respect to GND.

### 7.2 Recommended Operating Conditions

over operating free-air temperature range (unless otherwise noted)

		MIN	NOM	MAX	UNIT
Supply voltage, $V_{DD}$	Single-supply	2.7		16	V
	Split-supply	$\pm 1.35$		$\pm 8$	
Common-mode input voltage, $V_{ICR}$		0		$V_{DD} - 1.35$	V
Operating free-air temperature, $T_A$	C-suffix	0		70	°C
	I-suffix	-40		125	

### 7.3 Thermal Information: TLV271

THERMAL METRIC <sup>(1)</sup>		TLV271			UNIT
		D (SOIC)	DBV (SOT-23)	P (PDIP)	
		8 PINS	5 PINS	8 PINS	
$R_{\theta JA}$	Junction-to-ambient thermal resistance	127.2	221.7	49.2	°C/W
$R_{\theta JC(top)}$	Junction-to-case (top) thermal resistance	71.6	144.7	39.4	°C/W
$R_{\theta JB}$	Junction-to-board thermal resistance	68.2	49.7	26.4	°C/W
$\Psi_{JT}$	Junction-to-top characterization parameter	22	26.1	15.4	°C/W
$\Psi_{JB}$	Junction-to-board characterization parameter	67.6	49	26.3	°C/W
$R_{\theta JC(bot)}$	Junction-to-case (bottom) thermal resistance	n/a	n/a	n/a	°C/W

(1) For more information about traditional and new thermal metrics, see the [Semiconductor and IC Package Thermal Metrics](#) application report.

### 7.4 Thermal Information: TLV272

THERMAL METRIC <sup>(1)</sup>		TLV272			UNIT
		D (SOIC)	DGK (VSSOP)	P (PDIP)	
		8 PINS	8 PINS	8 PINS	
$R_{\theta JA}$	Junction-to-ambient thermal resistance	127.2	186.6	49.2	°C/W
$R_{\theta JC(top)}$	Junction-to-case (top) thermal resistance	71.6	78.8	39.4	°C/W
$R_{\theta JB}$	Junction-to-board thermal resistance	68.2	107.9	26.4	°C/W
$\Psi_{JT}$	Junction-to-top characterization parameter	22	15.5	15.4	°C/W
$\Psi_{JB}$	Junction-to-board characterization parameter	67.6	106.3	26.3	°C/W
$R_{\theta JC(bot)}$	Junction-to-case (bottom) thermal resistance	n/a	n/a	n/a	°C/W

(1) For more information about traditional and new thermal metrics, see the [Semiconductor and IC Package Thermal Metrics](#) application report.

### 7.5 Thermal Information: TLV274

THERMAL METRIC <sup>(1)</sup>		TLV274			UNIT
		D (SOIC)	N (PDIP)	PW (TSSOP)	
		14 PINS	14 PINS	14 PINS	
$R_{\theta JA}$	Junction-to-ambient thermal resistance	97	66.3	135	°C/W
$R_{\theta JC(top)}$	Junction-to-case (top) thermal resistance	56	20.5	45	°C/W
$R_{\theta JB}$	Junction-to-board thermal resistance	53	26.8	66	°C/W
$\Psi_{JT}$	Junction-to-top characterization parameter	19	2.1	n/a	°C/W
$\Psi_{JB}$	Junction-to-board characterization parameter	46	26.2	60	°C/W
$R_{\theta JC(bot)}$	Junction-to-case (bottom) thermal resistance	n/a	n/a	n/a	°C/W

(1) For more information about traditional and new thermal metrics, see the [Semiconductor and IC Package Thermal Metrics](#) application report.

## 7.6 Electrical Characteristics: DC Characteristics

 at specified free-air temperature,  $V_{DD} = 2.7\text{ V}$ ,  $5\text{ V}$ , and  $\pm 5\text{ V}$  (unless otherwise noted)

PARAMETER		TEST CONDITIONS		$T_A^{(1)}$	MIN	TYP	MAX	UNIT
$V_{IO}$	Input offset voltage	$V_{IC} = V_{DD}/2$ , $R_L = 10\text{ k}\Omega$ , $V_O = V_{DD}/2$ , $R_S = 50\ \Omega$		25°C		0.5	5	mV
				Full range			7	
$\alpha V_{IO}$	Offset voltage drift			25°C		2		$\mu\text{V}/^\circ\text{C}$
CMRR	Common-mode rejection ratio	$V_{IC} = 0\text{ to }V_{DD} - 1.35\text{ V}$ , $R_S = 50\ \Omega$	$V_{DD} = 2.7\text{ V}$	25°C	58	70	dB	
				Full range	55			
		$V_{DD} = 5\text{ V}$	25°C	65	80			
			Full range	62				
		$V_{DD} = \pm 5\text{ V}$	25°C	69	85			
			Full range	66				
$A_{VD}$	Large-signal differential voltage amplification	$V_{O(PP)} = V_{DD}/2$ , $R_L = 10\text{ k}\Omega$	$V_{DD} = 2.7\text{ V}$	25°C	97	106	dB	
				Full range	76			
			$V_{DD} = 5\text{ V}$	25°C	100	110		
				Full range	86			
			$V_{DD} = \pm 5\text{ V}$	25°C	100	115		
				Full range	90			

(1) Full range is 0°C to 70°C for C-suffix and full range is –40°C to 125°C for I-suffix. If not specified, full range is –40°C to 125°C.

## 7.7 Electrical Characteristics: Input Characteristics

 at specified free-air temperature,  $V_{DD} = 2.7\text{ V}$ ,  $5\text{ V}$ , and  $\pm 5\text{ V}$  (unless otherwise noted).

PARAMETER	TEST CONDITIONS	$T_A$	MIN	TYP	MAX	UNIT
$I_{IO}$	$V_{DD} = 5\text{ V}$ , $V_{IC} = V_{DD}/2$ , $V_O = V_{DD}/2$ , $R_S = 50\ \Omega$	25°C		1	60	pA
		70°C			100	
		125°C			1000	
$I_{IB}$	$V_{DD} = 5\text{ V}$ , $V_{IC} = V_{DD}/2$ , $V_O = V_{DD}/2$ , $R_S = 50\ \Omega$	25°C		1	60	pA
		70°C			100	
		125°C			1000	
$r_{i(d)}$	Differential input resistance	25°C		1000		G $\Omega$
$C_{IC}$	Common-mode input capacitance	$f = 21\text{ kHz}$		8		pF



## 7.8 Electrical Characteristics: Output Characteristics

 at specified free-air temperature,  $V_{DD} = 2.7\text{ V}$ ,  $5\text{ V}$ , and  $\pm 5\text{ V}$  (unless otherwise noted).

PARAMETER	TEST CONDITIONS		$T_A$	MIN	TYP	MAX	UNIT
$V_{OH}$ High-level output voltage	$V_{IC} = V_{DD}/2, I_{OH} = -1\text{ mA}$	$V_{DD} = 2.7\text{ V}$	25°C	2.55	2.58		V
			Full range	2.48			
		$V_{DD} = 5\text{ V}$	25°C	4.9	4.93		
			Full range	4.85			
		$V_{DD} = \pm 5\text{ V}$	25°C	4.92	4.96		
			Full range	4.9			
	$V_{IC} = V_{DD}/2, I_{OH} = -5\text{ mA}$	$V_{DD} = 2.7\text{ V}$	25°C	1.9	2.1		
			Full range	1.5			
		$V_{DD} = 5\text{ V}$	25°C	4.6	4.68		
			Full range	4.5			
		$V_{DD} = \pm 5\text{ V}$	25°C	4.7	4.84		
			Full range	4.65			
$V_{OL}$ Low-level output voltage	$V_{IC} = V_{DD}/2, I_{OH} = 1\text{ mA}$	$V_{DD} = 2.7\text{ V}$	25°C		0.1	0.15	V
			Full range			0.22	
		$V_{DD} = 5\text{ V}$	25°C		0.05	0.1	
			Full range			0.15	
		$V_{DD} = \pm 5\text{ V}$	25°C		-4.95	-4.92	
			Full range			-4.9	
	$V_{IC} = V_{DD}/2, I_{OH} = 5\text{ mA}$	$V_{DD} = 2.7\text{ V}$	25°C		0.5	0.7	
			Full range			1.1	
		$V_{DD} = 5\text{ V}$	25°C		0.28	0.4	
			Full range			0.5	
		$V_{DD} = \pm 5\text{ V}$	25°C		-4.84	-4.7	
			Full range			-4.65	
$I_O$ Output current	$V_O = 0.5\text{ V from rail}, V_{DD} = 2.7\text{ V}$	Positive rail	25°C		4	mA	
		Negative rail	25°C		5		
	$V_O = 0.5\text{ V from rail}, V_{DD} = 5\text{ V}$	Positive rail	25°C		7		
		Negative rail	25°C		8		
	$V_O = 0.5\text{ V from rail}, V_{DD} = 10\text{ V}$	Positive rail	25°C		13		
		Negative rail	25°C		12		

## 7.9 Electrical Characteristics: Power Supply

 at specified free-air temperature,  $V_{DD} = 2.7\text{ V}$ ,  $5\text{ V}$ , and  $\pm 5\text{ V}$  (unless otherwise noted).

PARAMETER		TEST CONDITIONS		$T_A^{(1)}$	MIN	TYP	MAX	UNIT
$I_{DD}$	Supply current (per channel)	$V_O = V_{DD}/2$	$V_{DD} = 2.7\text{ V}$	25°C		470	560	$\mu\text{A}$
			$V_{DD} = 5\text{ V}$	25°C		550	660	
			$V_{DD} = 10\text{ V}$	25°C		625	800	
			Full range				1000	
PSRR	Supply voltage rejection ratio ( $\Delta V_{DD} / \Delta V_{IO}$ )	$V_{DD} = 2.7\text{ V}$ to $16\text{ V}$ , $V_{IC} = V_{DD}/2$ , no load		25°C	70	80		dB
				Full range	65			

(1) Full range is 0°C to 70°C for C-suffix and full range is –40°C to 125°C for I-suffix. If not specified, full range is –40°C to 125°C.

## 7.10 Electrical Characteristics: Dynamic Performance

over operating free-air temperature range (unless otherwise noted).

PARAMETER		TEST CONDITIONS		$T_A^{(1)}$	MIN	TYP	MAX	UNIT
UGBW	Unity-gain bandwidth	$R_L = 2\text{ k}\Omega$ , $C_L = 10\text{ pF}$	$V_{DD} = 2.7\text{ V}$	25°C		2.4		MHz
			$V_{DD} = 5\text{ V}$ to $10\text{ V}$	25°C		3		
SR	Slew rate at unity gain	$V_{O(PP)} = V_{DD}/2$ , $C_L = 50\text{ pF}$ , $R_L = 10\text{ k}\Omega$	$V_{DD} = 2.7\text{ V}$	25°C	1.35	2.1		$\text{V}/\mu\text{s}$
				Full range	1			
			$V_{DD} = 5\text{ V}$	25°C	1.45	2.4		$\text{V}/\mu\text{s}$
				Full range	1.2			
			$V_{DD} = \pm 5\text{ V}$	25°C	1.8	2.6		$\text{V}/\mu\text{s}$
				Full range	1.3			
$\phi_m$	Phase margin	$R_L = 2\text{ k}\Omega$	$C_L = 10\text{ pF}$	25°C		65		°
	Gain margin	$R_L = 2\text{ k}\Omega$	$C_L = 10\text{ pF}$	25°C		18		dB
$t_s$	Setting time	$V_{DD} = 2.7\text{ V}$ , $V_{(STEP)PP} = 1\text{ V}$ , $A_V = -1$ , $C_L = 10\text{ pF}$ , $R_L = 2\text{ k}\Omega$	0.1%	25°C		2.9		$\mu\text{s}$
			0.1%			2		
		$V_{DD} = 5\text{ V}$ , $\pm 5\text{ V}$ , $V_{(STEP)PP} = 1\text{ V}$ , $A_V = -1$ , $C_L = 47\text{ pF}$ , $R_L = 2\text{ k}\Omega$						

(1) Full range is 0°C to 70°C for C suffix and full range is –40°C to 125°C for I suffix. If not specified, full range is –40°C to 125°C.

## 7.11 Electrical Characteristics: Noise/Distortion Performance

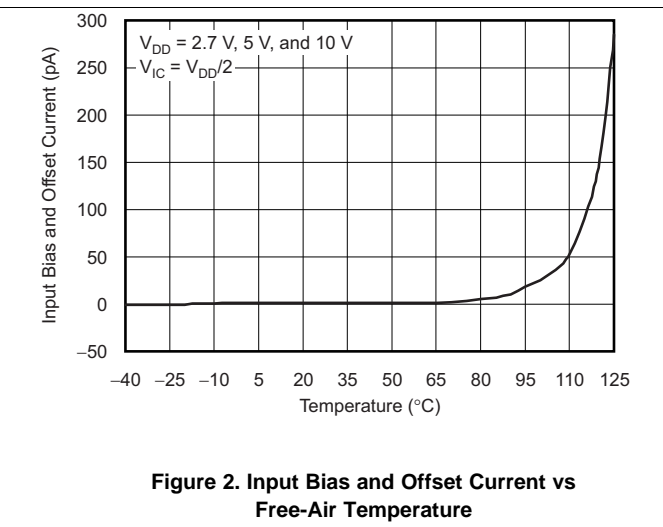
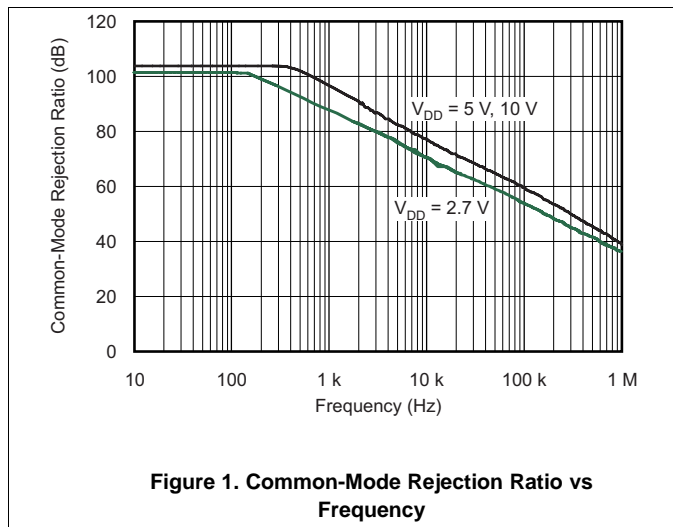
over operating free-air temperature range (unless otherwise noted).

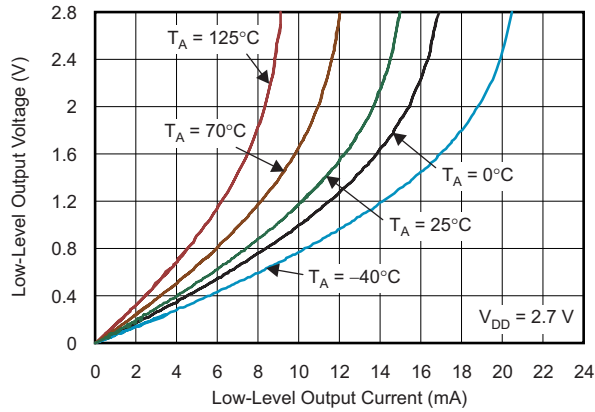
PARAMETER		TEST CONDITIONS		$T_A$	MIN	TYP	MAX	UNIT
THD + N	Total harmonic distortion plus noise	$V_{DD} = 2.7\text{ V}$ , $V_{O(PP)} = V_{DD}/2\text{ V}$ , $R_L = 2\text{ k}\Omega$ , $f = 10\text{ kHz}$	$A_V = 1$	25°C		0.02%		
			$A_V = 10$			0.05%		
			$A_V = 100$			0.18%		
		$V_{DD} = 5\text{ V}$ , $\pm 5\text{ V}$ , $V_{O(PP)} = V_{DD}/2\text{ V}$ , $R_L = 2\text{ k}\Omega$ , $f = 10\text{ kHz}$	$A_V = 1$	25°C		0.02%		
			$A_V = 10$			0.09%		
			$A_V = 100$			0.5%		
$V_n$	Equivalent input noise voltage	$f = 1\text{ kHz}$	25°C		39		$\text{nV}/\sqrt{\text{Hz}}$	
		$f = 10\text{ kHz}$			35			
$I_n$	Equivalent input noise current	$f = 1\text{ kHz}$	25°C		0.6		$\text{fA}/\sqrt{\text{Hz}}$	

**7.12 Typical Characteristics**

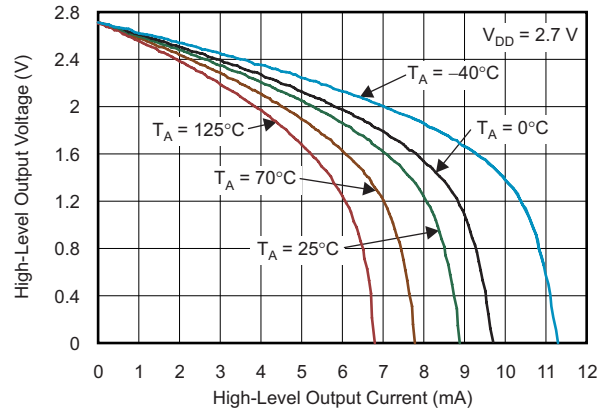
**Table 1. Table of Graphs**

DESCRIPTION		FIGURE NO.
CMRR	Common-mode rejection ratio	vs Frequency
	Input bias and offset current	vs Free-air temperature
V <sub>OL</sub>	Low-level output voltage	vs Low-level output current
V <sub>OH</sub>	High-level output voltage	vs High-level output current
V <sub>O(PP)</sub>	Peak-to-peak output voltage	vs Frequency
I <sub>DD</sub>	Supply current	vs Supply voltage
PSRR	Power-supply rejection ratio	vs Frequency
A <sub>VD</sub>	Differential voltage gain and phase	vs Frequency
	Gain-bandwidth product	vs Free-air temperature
SR	Slew rate	vs Supply voltage
		vs Free-air temperature
φ <sub>m</sub>	Phase margin	vs Capacitive load
V <sub>n</sub>	Equivalent input noise voltage	vs Frequency
	Voltage-follower large-signal pulse response	
	Voltage-follower small-signal pulse response	
	Inverting large-signal response	
	Inverting small-signal response	
	Crosstalk	vs Frequency

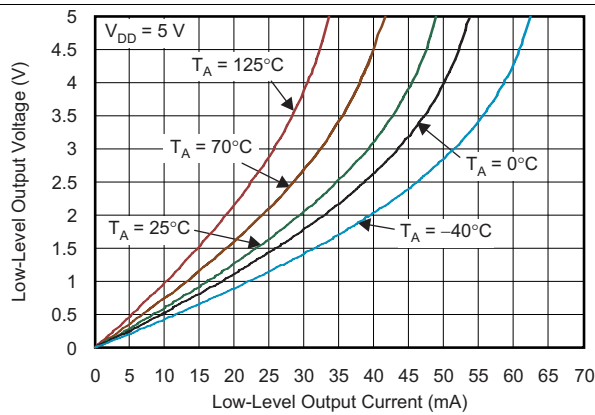




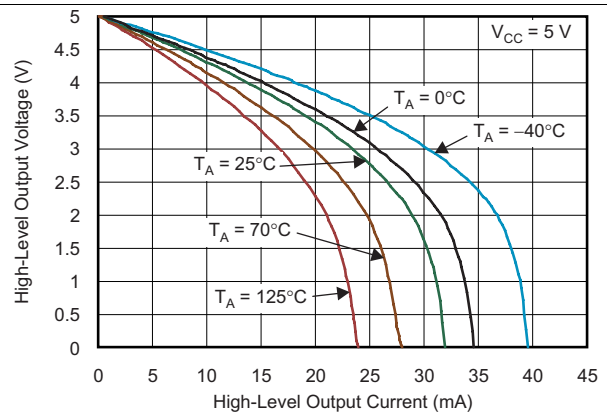
**Figure 3. Low-Level Output Voltage vs Low-Level Output Current**



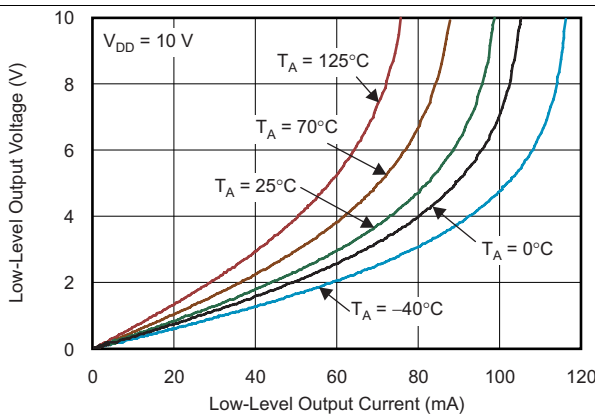
**Figure 4. High-Level Output Voltage vs High-Level Output Current**



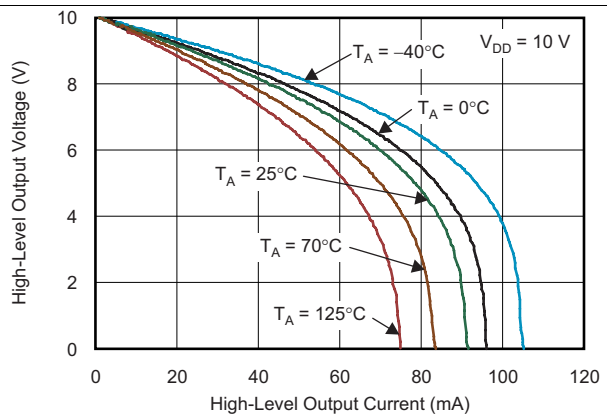
**Figure 5. Low-Level Output Voltage vs Low-Level Output Current**



**Figure 6. High-Level Output Voltage vs High-Level Output Current**



**Figure 7. Low-Level Output Voltage vs Low-Level Output Current**



**Figure 8. High-Level Output Voltage vs High-Level Output Current**

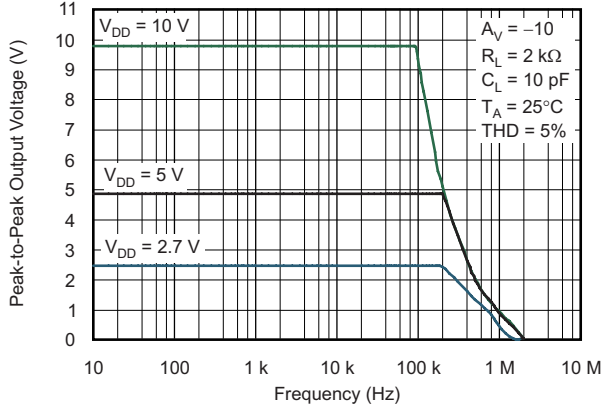


Figure 9. Peak-to-Peak Output Voltage vs Frequency

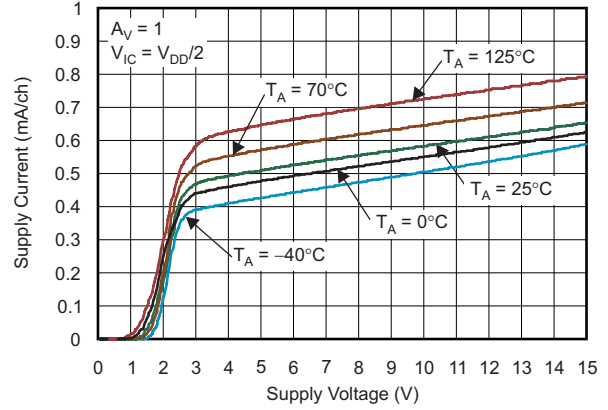


Figure 10. Supply Current vs Supply Voltage

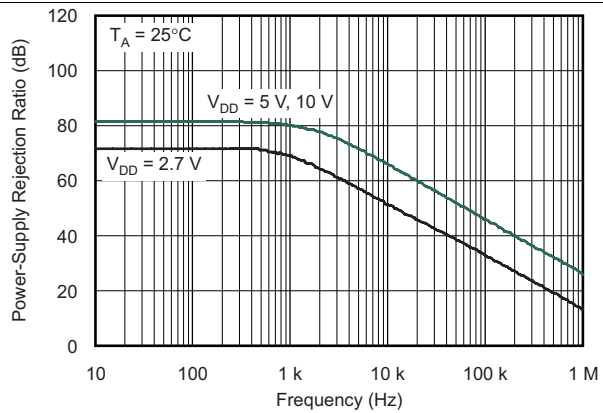


Figure 11. Power-Supply Rejection Ratio vs Frequency

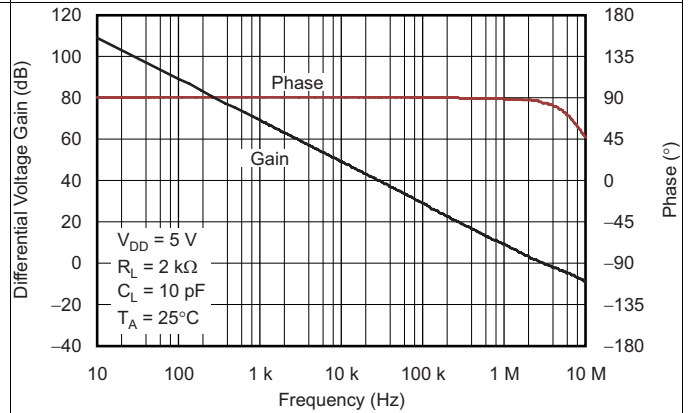


Figure 12. Differential Voltage Gain and Phase

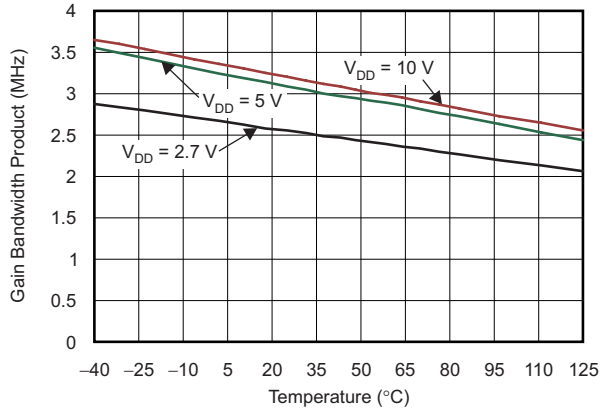


Figure 13. Gain Bandwidth Product vs Free-Air Temperature

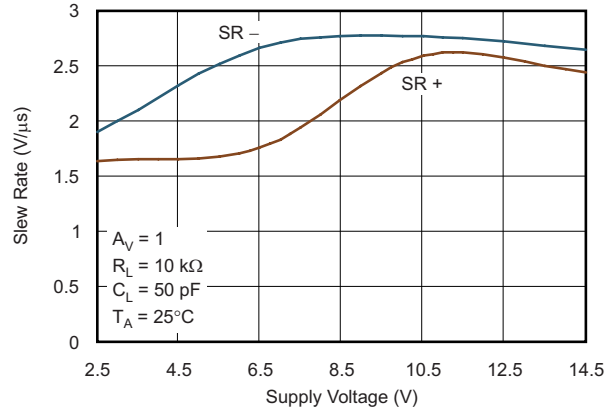


Figure 14. Slew Rate vs Supply Voltage

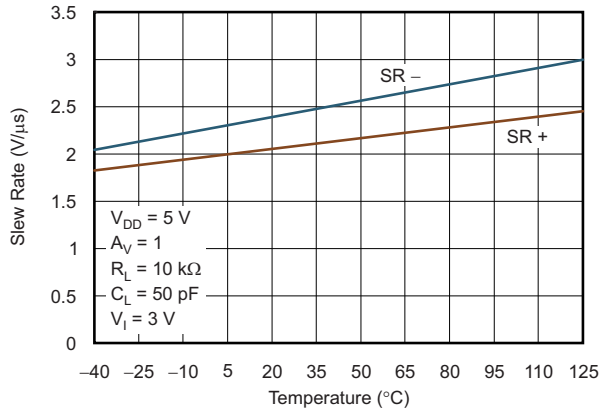


Figure 15. Slew Rate vs Free-Air Temperature

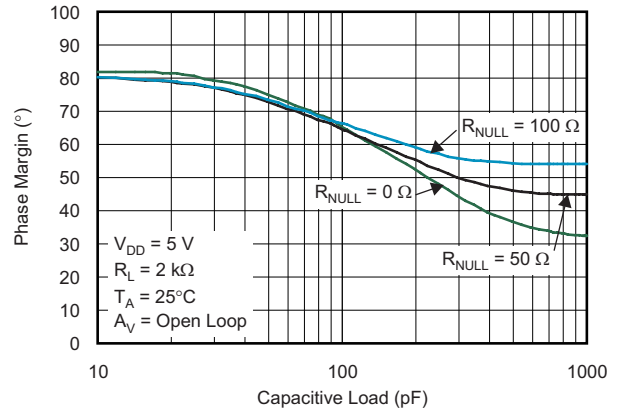


Figure 16. Phase Margin vs Capacitive Load

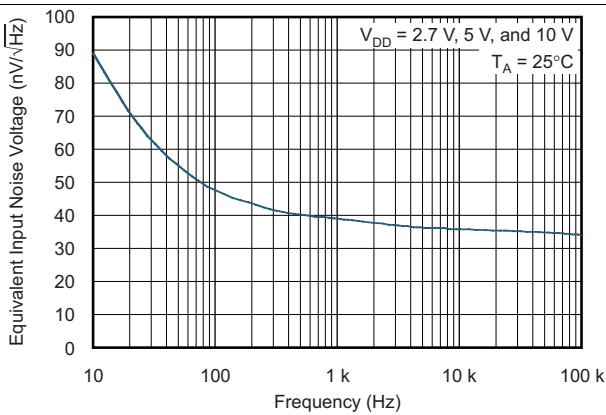


Figure 17. Equivalent Input Noise Voltage vs Frequency

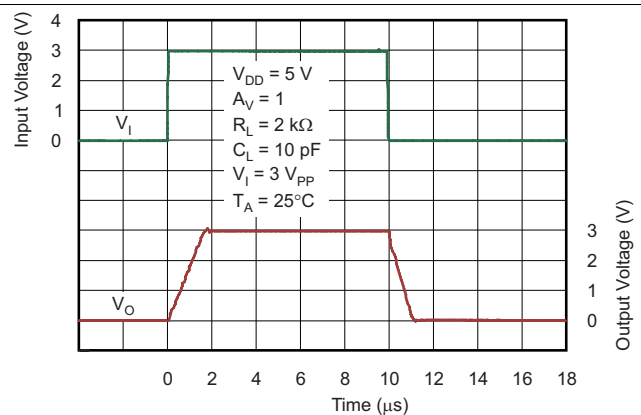


Figure 18. Voltage-Follower Large-Signal Pulse Response

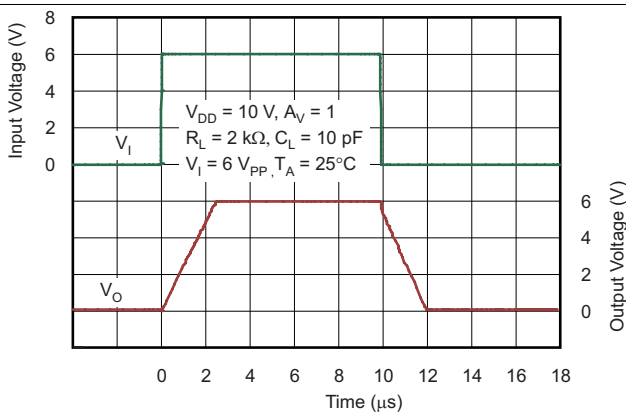


Figure 19. Voltage-Follower Large-Signal Pulse Response

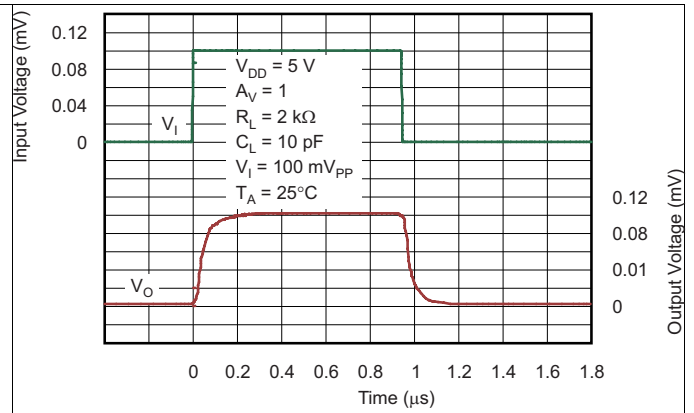
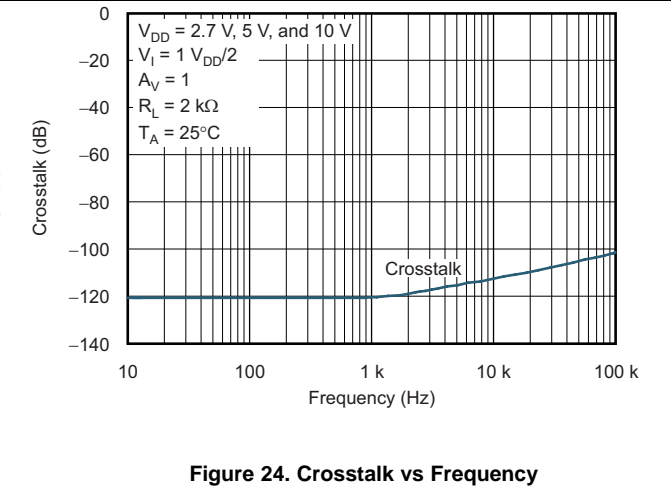
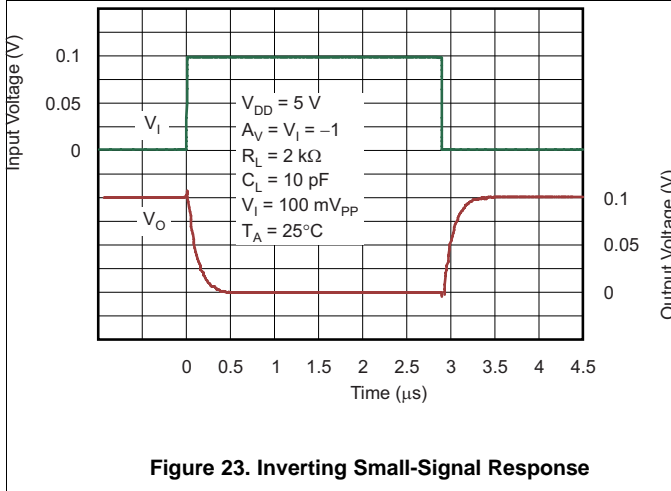
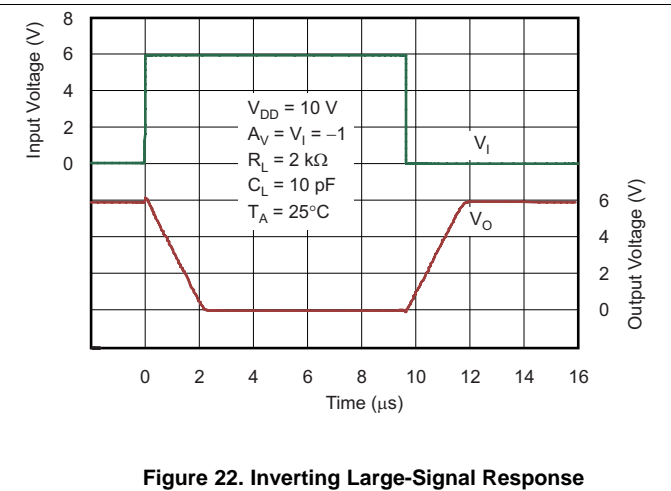
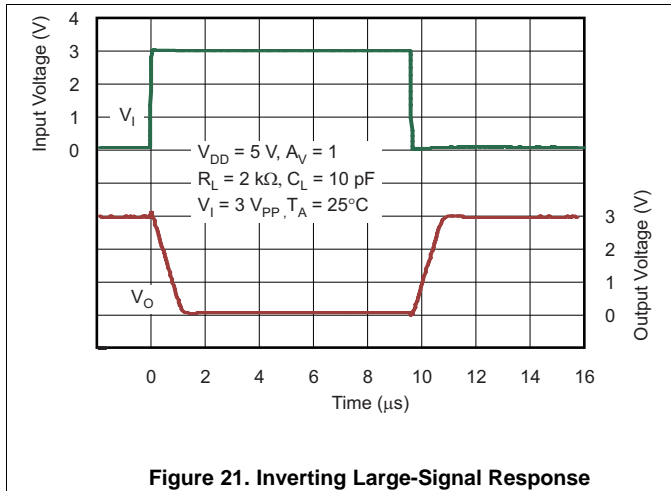


Figure 20. Voltage-Follower Small-Signal Pulse Response







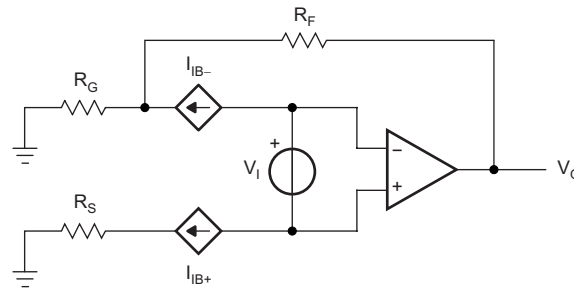
## 8.3 Feature Description

### 8.3.1 Rail to Rail Output

The TLV27x family of opamps features a rail to rail output stage. Rail to rail outputs allow for a wide dynamic range in low voltage systems. This feature along with low power and wide bandwidth make the TLV27x family suitable for portable and battery powered systems.

### 8.3.2 Offset Voltage

The output offset voltage ( $V_{OO}$ ) is the sum of the input offset voltage ( $V_{IO}$ ) and both input bias currents ( $I_{IB}$ ) times the corresponding gains. Use the schematic in [Figure 25](#) and [Equation 1](#) to calculate the output offset voltage:



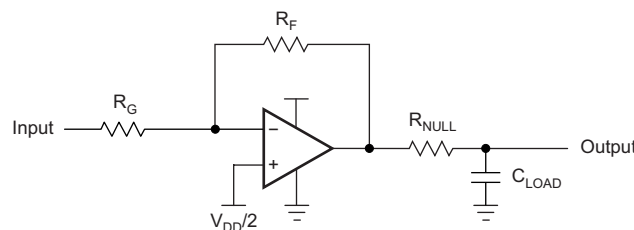
Copyright © 2016, Texas Instruments Incorporated

**Figure 25. Output Offset Voltage Model**

$$V_{OO} = V_{IO} \left[ 1 + \left( \frac{R_F}{R_G} \right) \right] \pm I_{IB+} R_S \left[ 1 + \left( \frac{R_F}{R_G} \right) \right] \pm I_{IB-} R_F \quad (1)$$

### 8.3.3 Driving a Capacitive Load

When the amplifier is configured in this manner, capacitive loading directly on the output decreases the device phase margin, leading to high frequency ringing or oscillations. Therefore, for capacitive loads of greater than 10 pF, TI recommends placing a resistor in series ( $R_{NULL}$ ) with the output of the amplifier, as shown in [Figure 26](#). A minimum value of 20  $\Omega$  should work well for most applications.



Copyright © 2016, Texas Instruments Incorporated

**Figure 26. Driving a Capacitive Load**

## 8.4 Device Functional Modes

The TLV27x has a single functional mode. It is operational when the power supply applied to the device is between 2.7 V ( $\pm 1.35$  V) and 16 V ( $\pm 8$  V). Electrical parameters that can vary with operating conditions are shown in [Typical Characteristics](#).

## 9 Application and Implementation

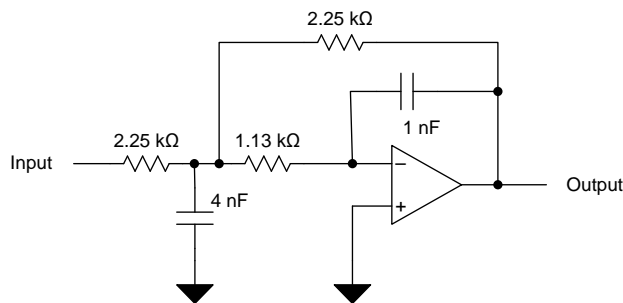
### NOTE

Information in the following applications sections is not part of the TI component specification, and TI does not warrant its accuracy or completeness. TI's customers are responsible for determining suitability of components for their purposes. Customers should validate and test their design implementation to confirm system functionality.

### 9.1 Application Information

The TLV27x family offers outstanding DC and AC performance. These devices operate up to a 16-V power supply and offer ultra-low input bias current and 3-MHz bandwidth. These features make the TLV27x a robust operational amplifier for battery-powered and industrial applications.

### 9.2 Typical Application



**Figure 27. Second-Order, Low-Pass Filter**

#### 9.2.1 Design Requirements

- Gain = 1 V/V
- Low-pass cutoff frequency = 50 kHz
- –40-dB/dec filter response
- Maintain less than 3-dB gain peaking in the gain versus frequency response

#### 9.2.2 Detailed Design Procedure

The infinite-gain multiple-feedback circuit for a low-pass network function is shown in [Figure 27](#). Use [Equation 2](#) to calculate the voltage transfer function.

$$\frac{\text{Output}}{\text{Input}}(s) = \frac{-1/R_1 R_3 C_2 C_5}{s^2 + (s/C_2)(1/R_1 + 1/R_3 + 1/R_4) + 1/R_3 R_4 C_2 C_5} \quad (2)$$

This circuit produces a signal inversion. For this circuit, the gain at DC and the low-pass cutoff frequency are calculated by [Equation 3](#):

$$\text{Gain} = \frac{R_4}{R_1}$$

$$f_c = \frac{1}{2\pi} \sqrt{(1/R_3 R_4 C_2 C_5)} \quad (3)$$

## Typical Application (continued)

Software tools are readily available to simplify filter design. WEBENCH® Filter Designer is a simple, powerful, and easy-to-use active filter design program. The [WEBENCH® Filter Designer](#) lets you create optimized filter designs using a selection of TI operational amplifiers and passive components from TI's vendor partners.

Available as a web-based tool from the WEBENCH Design Center, WEBENCH Filter Designer allows you to design, optimize, and simulate complete multistage active filter solutions within minutes.

### 9.2.3 Application Curve

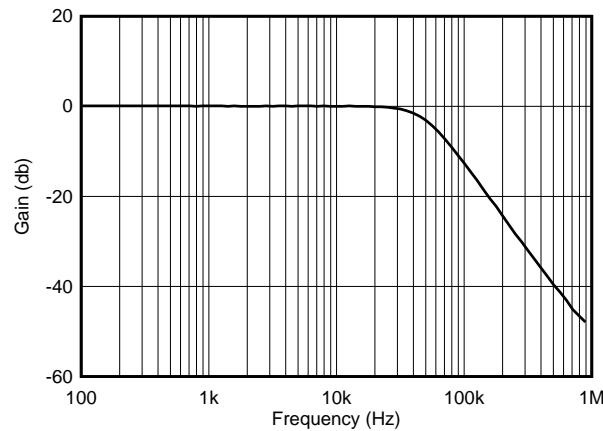
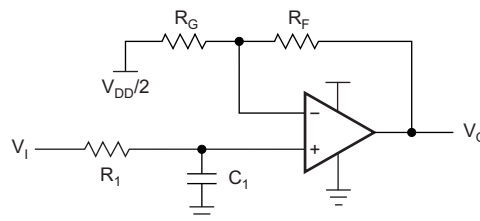


Figure 28. TLV27x Second-Order, 50-kHz, Low-Pass Filter

## 9.3 System Examples

### 9.3.1 General Configurations

When receiving low-level signals, limiting the bandwidth of the incoming signals into the system is often required. The simplest way to accomplish this limiting is to place an RC filter at the noninverting terminal of the amplifier (see [Figure 29](#) and [Equation 4](#)).



Copyright © 2016, Texas Instruments Incorporated

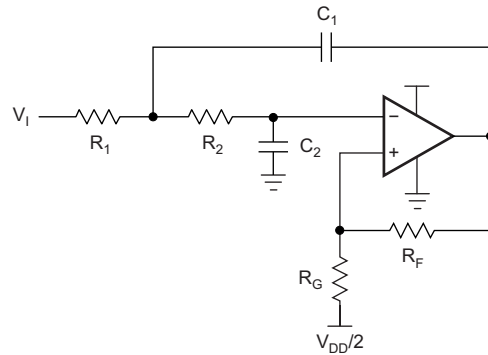
Figure 29. Single-Pole Low-Pass Filter

$$\frac{V_O}{V_I} = \left(1 + \frac{R_F}{R_G}\right) \left(\frac{1}{1 + sR_1C_1}\right)$$

$$f_{-3db} = \frac{1}{2\pi R_1 C_1} \tag{4}$$

### System Examples (continued)

If even more attenuation is needed, a multiple pole filter is required. The Sallen-Key filter, shown in [Figure 30](#), can be used for this task. For best results, the amplifier should have a bandwidth that is 8 to 10 times the filter frequency bandwidth; refer to [Equation 5](#). Failure to use an amplifier with this characteristic can result in phase shift of the amplifier.



Copyright © 2016, Texas Instruments Incorporated

**Figure 30. Two-Pole, Low-Pass, Sallen-Key Filter**

$R_1 = R_2 = R$   
 $C_1 = C_2 = C$   
 $Q = \text{Peaking Factor}$   
 (Butterworth  $Q = 0.707$ )

$$f_{-3\text{db}} = \frac{1}{2\pi RC}$$

$$R_G = \frac{R_F}{\left(2 - \frac{1}{Q}\right)}$$

(5)

## 10 Power Supply Recommendations

The TLV27x is specified for operation from 2.7 V to 16 V ( $\pm 1.35$  V to  $\pm 8$  V); many specifications apply from  $-40^{\circ}\text{C}$  to  $125^{\circ}\text{C}$ . Parameters that can exhibit significant variance with regard to operating voltage or temperature are presented in the [Typical Characteristics](#).

### CAUTION

Supply voltages larger than 16.5 V can permanently damage the device; see the [Absolute Maximum Ratings](#).

Place 0.1- $\mu\text{F}$  bypass capacitors close to the power-supply pins to reduce errors coupling in from noisy or high-impedance power supplies. For more detailed information on bypass capacitor placement, see [Layout Guidelines](#).

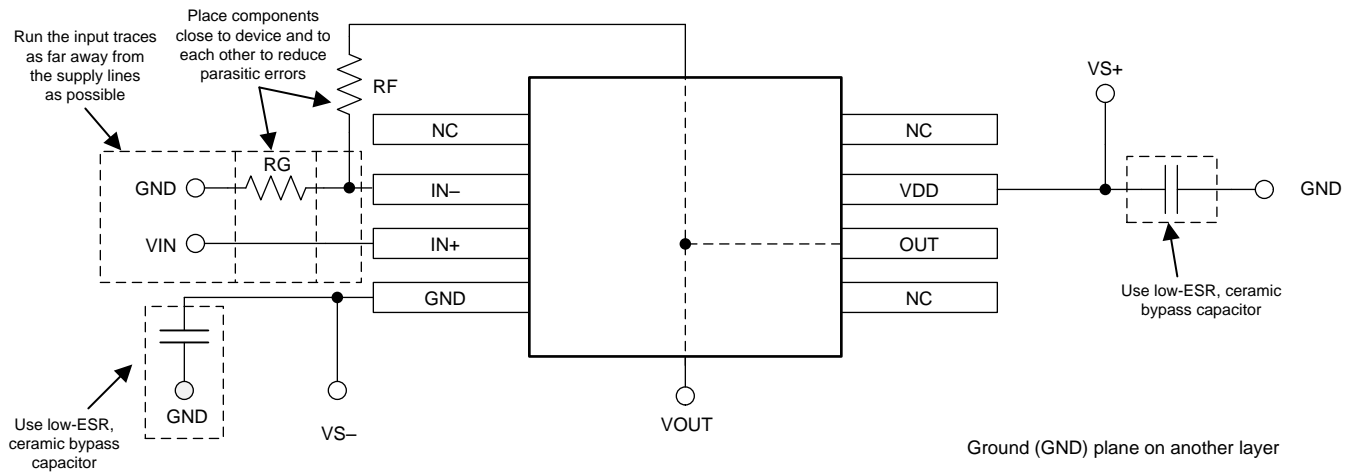
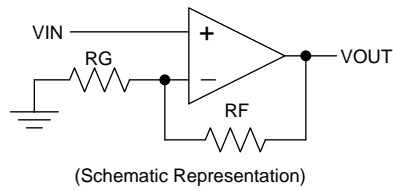
## 11 Layout

### 11.1 Layout Guidelines

To achieve the levels of high performance of the TLV27x, follow proper printed circuit board (PCB) design techniques. A general set of guidelines is given in the following.

- Ground planes—TI highly recommends using a ground plane on the board to provide all components with a low-inductive ground connection. However, in the areas of the amplifier inputs and output, the ground plane can be removed to minimize the stray capacitance.
- Proper power supply decoupling—Use a 6.8- $\mu\text{F}$  tantalum capacitor in parallel with a 0.1- $\mu\text{F}$  ceramic capacitor on each supply terminal. It may be possible to share the tantalum among several amplifiers depending on the application, but a 0.1- $\mu\text{F}$  ceramic capacitor should always be used on the supply terminal of every amplifier. In addition, the 0.1- $\mu\text{F}$  capacitor should be placed as close as possible to the supply terminal. As this distance increases, the inductance in the connecting trace makes the capacitor less effective. The designer should strive for distances of less than 0.1 inches between the device power terminals and the ceramic capacitors.
- Sockets—Sockets can be used but are not recommended. The additional lead inductance in the socket pins often leads to stability problems. Surface-mount packages soldered directly to the printed-circuit board is the best implementation.
- Short trace runs/compact part placements—Optimum high performance is achieved when stray series inductance has been minimized. To realize this, the circuit layout should be made as compact as possible, thereby minimizing the length of all trace runs. Particular attention should be paid to the inverting input of the amplifier. Its length should be kept as short as possible. This helps to minimize stray capacitance at the input of the amplifier.
- Surface-mount passive components—Using surface-mount passive components is recommended for high performance amplifier circuits for several reasons. First, because of the extremely low lead inductance of surface-mount components, the problem with stray series inductance is greatly reduced. Second, the small size of surface-mount components naturally leads to a more compact layout thereby minimizing both stray inductance and capacitance. If leaded components are used, TI recommends keeping the lead lengths as short as possible.

## 11.2 Layout Example



Copyright © 2016, Texas Instruments Incorporated

**Figure 31. TLV27x Layout Example**

## 12 Device and Documentation Support

### 12.1 Documentation Support

#### 12.1.1 Related Documentation

The following documents are relevant to using the TLV27x, and recommended for reference. All are available for download at [www.ti.com](http://www.ti.com) unless otherwise noted.

- [Compensate Transimpedance Amplifiers Intuitively](#) (SBOA055)
- [Operational amplifier gain stability, Part 3: AC gain-error analysis](#) (SLYT383)
- [Operational amplifier gain stability, Part 2: DC gain-error analysis](#) (SLYT374)
- [Using the infinite-gain, MFB filter topology in fully differential active filters](#) (SLYT343)
- [Op Amp Performance Analysis](#) (SBOA054)
- [Single-Supply Operation of Operational Amplifiers](#) (SBOA059)
- [Tuning in Amplifiers](#) (SBOA067)
- [Shelf-Life Evaluation of Lead-Free Component Finishes](#) (SZZA046)

#### 12.2 Related Links

[Table 2](#) lists quick access links. Categories include technical documents, support and community resources, tools and software, and quick access to sample or buy.

**Table 2. Related Links**

PARTS	PRODUCT FOLDER	SAMPLE & BUY	TECHNICAL DOCUMENTS	TOOLS & SOFTWARE	SUPPORT & COMMUNITY
TLV271	<a href="#">Click here</a>	<a href="#">Click here</a>	<a href="#">Click here</a>	<a href="#">Click here</a>	<a href="#">Click here</a>
TLV272	<a href="#">Click here</a>	<a href="#">Click here</a>	<a href="#">Click here</a>	<a href="#">Click here</a>	<a href="#">Click here</a>
TLV274	<a href="#">Click here</a>	<a href="#">Click here</a>	<a href="#">Click here</a>	<a href="#">Click here</a>	<a href="#">Click here</a>

#### 12.3 Receiving Notification of Documentation Updates

To receive notification of documentation updates, navigate to the device product folder on ti.com. In the upper right corner, click on *Alert me* to register and receive a weekly digest of any product information that has changed. For change details, review the revision history included in any revised document.

#### 12.4 Community Resource

The following links connect to TI community resources. Linked contents are provided "AS IS" by the respective contributors. They do not constitute TI specifications and do not necessarily reflect TI's views; see TI's [Terms of Use](#).

**TI E2E™ Online Community** *TI's Engineer-to-Engineer (E2E) Community*. Created to foster collaboration among engineers. At [e2e.ti.com](http://e2e.ti.com), you can ask questions, share knowledge, explore ideas and help solve problems with fellow engineers.

**Design Support** *TI's Design Support* Quickly find helpful E2E forums along with design support tools and contact information for technical support.

#### 12.5 Trademarks

E2E is a trademark of Texas Instruments.  
 WEBENCH is a registered trademark of Texas Instruments.  
 All other trademarks are the property of their respective owners.

#### 12.6 Electrostatic Discharge Caution



These devices have limited built-in ESD protection. The leads should be shorted together or the device placed in conductive foam during storage or handling to prevent electrostatic damage to the MOS gates.

## 12.7 Glossary

[SLYZ022](#) — *TI Glossary*.

This glossary lists and explains terms, acronyms, and definitions.

## 13 Mechanical, Packaging, and Orderable Information

The following pages include mechanical, packaging, and orderable information. This information is the most current data available for the designated devices. This data is subject to change without notice and revision of this document. For browser-based versions of this data sheet, refer to the left-hand navigation.



**PACKAGING INFORMATION**

Orderable Device	Status (1)	Package Type	Package Drawing	Pins	Package Qty	Eco Plan (2)	Lead/Ball Finish (6)	MSL Peak Temp (3)	Op Temp (°C)	Device Marking (4/5)	Samples
TLV271CD	ACTIVE	SOIC	D	8	75	Green (RoHS & no Sb/Br)	CU NIPDAU	Level-1-260C-UNLIM	0 to 70	T271C	<a href="#">Samples</a>
TLV271CDBVR	ACTIVE	SOT-23	DBV	5	3000	Green (RoHS & no Sb/Br)	CU NIPDAU	Level-1-260C-UNLIM	0 to 70	VBHC	<a href="#">Samples</a>
TLV271CDBVRG4	ACTIVE	SOT-23	DBV	5	3000	Green (RoHS & no Sb/Br)	CU NIPDAU	Level-1-260C-UNLIM	0 to 70	VBHC	<a href="#">Samples</a>
TLV271CDBVT	ACTIVE	SOT-23	DBV	5	250	Green (RoHS & no Sb/Br)	CU NIPDAU	Level-1-260C-UNLIM	0 to 70	VBHC	<a href="#">Samples</a>
TLV271CDBVTG4	ACTIVE	SOT-23	DBV	5	250	Green (RoHS & no Sb/Br)	CU NIPDAU	Level-1-260C-UNLIM	0 to 70	VBHC	<a href="#">Samples</a>
TLV271CDG4	ACTIVE	SOIC	D	8	75	Green (RoHS & no Sb/Br)	CU NIPDAU	Level-1-260C-UNLIM	0 to 70	T271C	<a href="#">Samples</a>
TLV271CDR	ACTIVE	SOIC	D	8	2500	Green (RoHS & no Sb/Br)	CU NIPDAU	Level-1-260C-UNLIM	0 to 70	T271C	<a href="#">Samples</a>
TLV271CDRG4	ACTIVE	SOIC	D	8	2500	Green (RoHS & no Sb/Br)	CU NIPDAU	Level-1-260C-UNLIM	0 to 70	T271C	<a href="#">Samples</a>
TLV271ID	ACTIVE	SOIC	D	8	75	Green (RoHS & no Sb/Br)	CU NIPDAU	Level-1-260C-UNLIM	-40 to 125	T271I	<a href="#">Samples</a>
TLV271IDBVR	ACTIVE	SOT-23	DBV	5	3000	Green (RoHS & no Sb/Br)	CU NIPDAU	Level-1-260C-UNLIM	-40 to 125	VBHI	<a href="#">Samples</a>
TLV271IDBVRG4	ACTIVE	SOT-23	DBV	5	3000	Green (RoHS & no Sb/Br)	CU NIPDAU	Level-1-260C-UNLIM	-40 to 125	VBHI	<a href="#">Samples</a>
TLV271IDBVT	ACTIVE	SOT-23	DBV	5	250	Green (RoHS & no Sb/Br)	CU NIPDAU	Level-1-260C-UNLIM	-40 to 125	VBHI	<a href="#">Samples</a>
TLV271IDBVTG4	ACTIVE	SOT-23	DBV	5	250	Green (RoHS & no Sb/Br)	CU NIPDAU	Level-1-260C-UNLIM	-40 to 125	VBHI	<a href="#">Samples</a>
TLV271IDG4	ACTIVE	SOIC	D	8	75	Green (RoHS & no Sb/Br)	CU NIPDAU	Level-1-260C-UNLIM	-40 to 125	T271I	<a href="#">Samples</a>
TLV271IDR	ACTIVE	SOIC	D	8	2500	Green (RoHS & no Sb/Br)	CU NIPDAU	Level-1-260C-UNLIM	-40 to 125	T271I	<a href="#">Samples</a>
TLV271IP	ACTIVE	PDIP	P	8	50	Pb-Free (RoHS)	CU NIPDAU	N / A for Pkg Type	-40 to 125	T271I	<a href="#">Samples</a>
TLV271IPE4	ACTIVE	PDIP	P	8	50	Pb-Free (RoHS)	CU NIPDAU	N / A for Pkg Type	-40 to 125	T271I	<a href="#">Samples</a>

Orderable Device	Status (1)	Package Type	Package Drawing	Pins	Package Qty	Eco Plan (2)	Lead/Ball Finish (6)	MSL Peak Temp (3)	Op Temp (°C)	Device Marking (4/5)	Samples
TLV272CD	ACTIVE	SOIC	D	8	75	Green (RoHS & no Sb/Br)	CU NIPDAU	Level-1-260C-UNLIM	0 to 70	T272C	<a href="#">Samples</a>
TLV272CDG4	ACTIVE	SOIC	D	8	75	Green (RoHS & no Sb/Br)	CU NIPDAU	Level-1-260C-UNLIM	0 to 70	T272C	<a href="#">Samples</a>
TLV272CDGK	ACTIVE	VSSOP	DGK	8	80	Green (RoHS & no Sb/Br)	CU NIPDAU   CU NIPDAUAG	Level-1-260C-UNLIM	0 to 70	AVF	<a href="#">Samples</a>
TLV272CDGKG4	ACTIVE	VSSOP	DGK	8	80	Green (RoHS & no Sb/Br)	CU NIPDAUAG	Level-1-260C-UNLIM	0 to 70	AVF	<a href="#">Samples</a>
TLV272CDGKR	ACTIVE	VSSOP	DGK	8	2500	Green (RoHS & no Sb/Br)	CU NIPDAU   CU NIPDAUAG	Level-1-260C-UNLIM	0 to 70	AVF	<a href="#">Samples</a>
TLV272CDGKRG4	ACTIVE	VSSOP	DGK	8	2500	Green (RoHS & no Sb/Br)	CU NIPDAUAG	Level-1-260C-UNLIM	0 to 70	AVF	<a href="#">Samples</a>
TLV272CDR	ACTIVE	SOIC	D	8	2500	Green (RoHS & no Sb/Br)	CU NIPDAU	Level-1-260C-UNLIM	0 to 70	T272C	<a href="#">Samples</a>
TLV272CDRG4	ACTIVE	SOIC	D	8	2500	Green (RoHS & no Sb/Br)	CU NIPDAU	Level-1-260C-UNLIM	0 to 70	T272C	<a href="#">Samples</a>
TLV272ID	ACTIVE	SOIC	D	8	75	Green (RoHS & no Sb/Br)	CU NIPDAU	Level-1-260C-UNLIM	-40 to 125	T272I	<a href="#">Samples</a>
TLV272IDG4	ACTIVE	SOIC	D	8	75	Green (RoHS & no Sb/Br)	CU NIPDAU	Level-1-260C-UNLIM	-40 to 125	T272I	<a href="#">Samples</a>
TLV272IDGK	ACTIVE	VSSOP	DGK	8	80	Green (RoHS & no Sb/Br)	CU NIPDAU   CU NIPDAUAG	Level-1-260C-UNLIM	-40 to 125	AVG	<a href="#">Samples</a>
TLV272IDGKG4	ACTIVE	VSSOP	DGK	8	80	Green (RoHS & no Sb/Br)	CU NIPDAUAG	Level-1-260C-UNLIM	-40 to 125	AVG	<a href="#">Samples</a>
TLV272IDGKR	ACTIVE	VSSOP	DGK	8	2500	Green (RoHS & no Sb/Br)	CU NIPDAU   CU NIPDAUAG	Level-1-260C-UNLIM	-40 to 125	AVG	<a href="#">Samples</a>
TLV272IDGKRG4	ACTIVE	VSSOP	DGK	8	2500	Green (RoHS & no Sb/Br)	CU NIPDAUAG	Level-1-260C-UNLIM	-40 to 125	AVG	<a href="#">Samples</a>
TLV272IDR	ACTIVE	SOIC	D	8	2500	Green (RoHS & no Sb/Br)	CU NIPDAU	Level-1-260C-UNLIM	-40 to 125	T272I	<a href="#">Samples</a>
TLV272IDRG4	ACTIVE	SOIC	D	8	2500	Green (RoHS & no Sb/Br)	CU NIPDAU	Level-1-260C-UNLIM	-40 to 125	T272I	<a href="#">Samples</a>
TLV272IP	ACTIVE	PDIP	P	8	50	Pb-Free (RoHS)	CU NIPDAU	N / A for Pkg Type	-40 to 125	T272I	<a href="#">Samples</a>
TLV272IPE4	ACTIVE	PDIP	P	8	50	Pb-Free (RoHS)	CU NIPDAU	N / A for Pkg Type	-40 to 125	T272I	<a href="#">Samples</a>

Orderable Device	Status (1)	Package Type	Package Drawing	Pins	Package Qty	Eco Plan (2)	Lead/Ball Finish (6)	MSL Peak Temp (3)	Op Temp (°C)	Device Marking (4/5)	Samples
TLV274CD	ACTIVE	SOIC	D	14	50	Green (RoHS & no Sb/Br)	CU NIPDAU	Level-1-260C-UNLIM	0 to 70	TLV274C	<a href="#">Samples</a>
TLV274CDG4	ACTIVE	SOIC	D	14	50	Green (RoHS & no Sb/Br)	CU NIPDAU	Level-1-260C-UNLIM	0 to 70	TLV274C	<a href="#">Samples</a>
TLV274CDR	ACTIVE	SOIC	D	14	2500	Green (RoHS & no Sb/Br)	CU NIPDAU	Level-1-260C-UNLIM	0 to 70	TLV274C	<a href="#">Samples</a>
TLV274CDRG4	ACTIVE	SOIC	D	14	2500	Green (RoHS & no Sb/Br)	CU NIPDAU	Level-1-260C-UNLIM	0 to 70	TLV274C	<a href="#">Samples</a>
TLV274CPW	ACTIVE	TSSOP	PW	14	90	Green (RoHS & no Sb/Br)	CU NIPDAU	Level-1-260C-UNLIM	0 to 70	TLV274C	<a href="#">Samples</a>
TLV274CPWG4	ACTIVE	TSSOP	PW	14	90	Green (RoHS & no Sb/Br)	CU NIPDAU	Level-1-260C-UNLIM	0 to 70	TLV274C	<a href="#">Samples</a>
TLV274CPWR	ACTIVE	TSSOP	PW	14	2000	Green (RoHS & no Sb/Br)	CU NIPDAU	Level-1-260C-UNLIM	0 to 70	TLV274C	<a href="#">Samples</a>
TLV274CPWRG4	ACTIVE	TSSOP	PW	14	2000	Green (RoHS & no Sb/Br)	CU NIPDAU	Level-1-260C-UNLIM	0 to 70	TLV274C	<a href="#">Samples</a>
TLV274ID	ACTIVE	SOIC	D	14	50	Green (RoHS & no Sb/Br)	CU NIPDAU	Level-1-260C-UNLIM	-40 to 125	TLV274I	<a href="#">Samples</a>
TLV274IDG4	ACTIVE	SOIC	D	14	50	Green (RoHS & no Sb/Br)	CU NIPDAU	Level-1-260C-UNLIM	-40 to 125	TLV274I	<a href="#">Samples</a>
TLV274IDR	ACTIVE	SOIC	D	14	2500	Green (RoHS & no Sb/Br)	CU NIPDAU	Level-1-260C-UNLIM	-40 to 125	TLV274I	<a href="#">Samples</a>
TLV274IDRG4	ACTIVE	SOIC	D	14	2500	Green (RoHS & no Sb/Br)	CU NIPDAU	Level-1-260C-UNLIM	-40 to 125	TLV274I	<a href="#">Samples</a>
TLV274IN	ACTIVE	PDIP	N	14	25	Pb-Free (RoHS)	CU NIPDAU	N / A for Pkg Type	-40 to 125	TLV274I	<a href="#">Samples</a>
TLV274INE4	ACTIVE	PDIP	N	14	25	Pb-Free (RoHS)	CU NIPDAU	N / A for Pkg Type	-40 to 125	TLV274I	<a href="#">Samples</a>
TLV274IPW	ACTIVE	TSSOP	PW	14	90	Green (RoHS & no Sb/Br)	CU NIPDAU	Level-1-260C-UNLIM	-40 to 125	TLV274I	<a href="#">Samples</a>
TLV274IPWG4	ACTIVE	TSSOP	PW	14	90	Green (RoHS & no Sb/Br)	CU NIPDAU	Level-1-260C-UNLIM	-40 to 125	TLV274I	<a href="#">Samples</a>
TLV274IPWR	ACTIVE	TSSOP	PW	14	2000	Green (RoHS & no Sb/Br)	CU NIPDAU	Level-1-260C-UNLIM	-40 to 125	TLV274I	<a href="#">Samples</a>
TLV274IPWRG4	ACTIVE	TSSOP	PW	14	2000	Green (RoHS & no Sb/Br)	CU NIPDAU	Level-1-260C-UNLIM	-40 to 125	TLV274I	<a href="#">Samples</a>

(1) The marketing status values are defined as follows:

**ACTIVE:** Product device recommended for new designs.

**LIFEBUY:** TI has announced that the device will be discontinued, and a lifetime-buy period is in effect.

**NRND:** Not recommended for new designs. Device is in production to support existing customers, but TI does not recommend using this part in a new design.

**PREVIEW:** Device has been announced but is not in production. Samples may or may not be available.

**OBSOLETE:** TI has discontinued the production of the device.

(2) **RoHS:** TI defines "RoHS" to mean semiconductor products that are compliant with the current EU RoHS requirements for all 10 RoHS substances, including the requirement that RoHS substance do not exceed 0.1% by weight in homogeneous materials. Where designed to be soldered at high temperatures, "RoHS" products are suitable for use in specified lead-free processes. TI may reference these types of products as "Pb-Free".

**RoHS Exempt:** TI defines "RoHS Exempt" to mean products that contain lead but are compliant with EU RoHS pursuant to a specific EU RoHS exemption.

**Green:** TI defines "Green" to mean the content of Chlorine (Cl) and Bromine (Br) based flame retardants meet JS709B low halogen requirements of  $\leq 1000$ ppm threshold. Antimony trioxide based flame retardants must also meet the  $\leq 1000$ ppm threshold requirement.

(3) MSL, Peak Temp. - The Moisture Sensitivity Level rating according to the JEDEC industry standard classifications, and peak solder temperature.

(4) There may be additional marking, which relates to the logo, the lot trace code information, or the environmental category on the device.

(5) Multiple Device Markings will be inside parentheses. Only one Device Marking contained in parentheses and separated by a "~" will appear on a device. If a line is indented then it is a continuation of the previous line and the two combined represent the entire Device Marking for that device.

(6) Lead/Ball Finish - Orderable Devices may have multiple material finish options. Finish options are separated by a vertical ruled line. Lead/Ball Finish values may wrap to two lines if the finish value exceeds the maximum column width.

**Important Information and Disclaimer:** The information provided on this page represents TI's knowledge and belief as of the date that it is provided. TI bases its knowledge and belief on information provided by third parties, and makes no representation or warranty as to the accuracy of such information. Efforts are underway to better integrate information from third parties. TI has taken and continues to take reasonable steps to provide representative and accurate information but may not have conducted destructive testing or chemical analysis on incoming materials and chemicals. TI and TI suppliers consider certain information to be proprietary, and thus CAS numbers and other limited information may not be available for release.

In no event shall TI's liability arising out of such information exceed the total purchase price of the TI part(s) at issue in this document sold by TI to Customer on an annual basis.

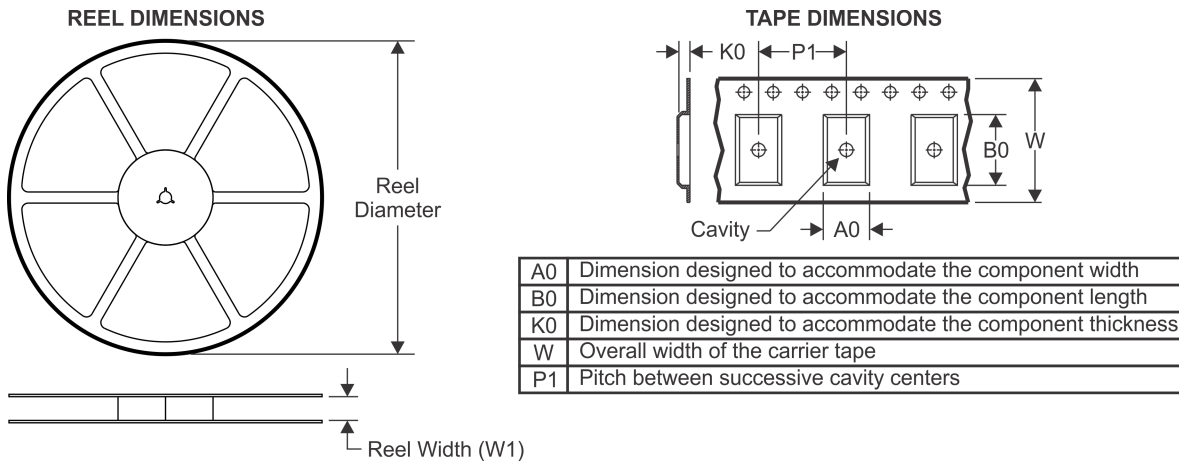
#### **OTHER QUALIFIED VERSIONS OF TLV271, TLV272, TLV274 :**

- Automotive: [TLV271-Q1](#), [TLV272-Q1](#), [TLV274-Q1](#)

NOTE: Qualified Version Definitions:

- Automotive - Q100 devices qualified for high-reliability automotive applications targeting zero defects

## TAPE AND REEL INFORMATION



### QUADRANT ASSIGNMENTS FOR PIN 1 ORIENTATION IN TAPE



\*All dimensions are nominal

Device	Package Type	Package Drawing	Pins	SPQ	Reel Diameter (mm)	Reel Width W1 (mm)	A0 (mm)	B0 (mm)	K0 (mm)	P1 (mm)	W (mm)	Pin1 Quadrant
TLV271CDBVR	SOT-23	DBV	5	3000	178.0	9.0	3.23	3.17	1.37	4.0	8.0	Q3
TLV271CDBVT	SOT-23	DBV	5	250	178.0	9.0	3.3	3.2	1.4	4.0	8.0	Q3
TLV271CDR	SOIC	D	8	2500	330.0	12.4	6.4	5.2	2.1	8.0	12.0	Q1
TLV271IDBVR	SOT-23	DBV	5	3000	178.0	9.0	3.3	3.2	1.4	4.0	8.0	Q3
TLV271IDBVT	SOT-23	DBV	5	250	178.0	9.0	3.3	3.2	1.4	4.0	8.0	Q3
TLV271IDR	SOIC	D	8	2500	330.0	12.4	6.4	5.2	2.1	8.0	12.0	Q1
TLV272CDGKR	VSSOP	DGK	8	2500	330.0	12.4	5.3	3.4	1.4	8.0	12.0	Q1
TLV272CDGKR	VSSOP	DGK	8	2500	330.0	12.4	5.3	3.4	1.4	8.0	12.0	Q1
TLV272CDR	SOIC	D	8	2500	330.0	12.4	6.4	5.2	2.1	8.0	12.0	Q1
TLV272IDGKR	VSSOP	DGK	8	2500	330.0	12.4	5.3	3.4	1.4	8.0	12.0	Q1
TLV272IDGKR	VSSOP	DGK	8	2500	330.0	12.4	5.3	3.4	1.4	8.0	12.0	Q1
TLV272IDR	SOIC	D	8	2500	330.0	12.4	6.4	5.2	2.1	8.0	12.0	Q1
TLV274CDR	SOIC	D	14	2500	330.0	16.4	6.5	9.0	2.1	8.0	16.0	Q1
TLV274CPWR	TSSOP	PW	14	2000	330.0	12.4	6.9	5.6	1.6	8.0	12.0	Q1
TLV274IDR	SOIC	D	14	2500	330.0	16.4	6.5	9.0	2.1	8.0	16.0	Q1
TLV274IPWR	TSSOP	PW	14	2000	330.0	12.4	6.9	5.6	1.6	8.0	12.0	Q1

**TAPE AND REEL BOX DIMENSIONS**


\*All dimensions are nominal

Device	Package Type	Package Drawing	Pins	SPQ	Length (mm)	Width (mm)	Height (mm)
TLV271CDBVR	SOT-23	DBV	5	3000	180.0	180.0	18.0
TLV271CDBVT	SOT-23	DBV	5	250	180.0	180.0	18.0
TLV271CDR	SOIC	D	8	2500	340.5	338.1	20.6
TLV271IDBVR	SOT-23	DBV	5	3000	180.0	180.0	18.0
TLV271IDBVT	SOT-23	DBV	5	250	180.0	180.0	18.0
TLV271IDR	SOIC	D	8	2500	340.5	338.1	20.6
TLV272CDGKR	VSSOP	DGK	8	2500	358.0	335.0	35.0
TLV272CDGKR	VSSOP	DGK	8	2500	364.0	364.0	27.0
TLV272CDR	SOIC	D	8	2500	340.5	338.1	20.6
TLV272IDGKR	VSSOP	DGK	8	2500	364.0	364.0	27.0
TLV272IDGKR	VSSOP	DGK	8	2500	358.0	335.0	35.0
TLV272IDR	SOIC	D	8	2500	340.5	338.1	20.6
TLV274CDR	SOIC	D	14	2500	333.2	345.9	28.6
TLV274CPWR	TSSOP	PW	14	2000	367.0	367.0	35.0
TLV274IDR	SOIC	D	14	2500	333.2	345.9	28.6
TLV274IPWR	TSSOP	PW	14	2000	367.0	367.0	35.0

P (R-PDIP-T8)

PLASTIC DUAL-IN-LINE PACKAGE



- NOTES:
- A. All linear dimensions are in inches (millimeters).
  - B. This drawing is subject to change without notice.
  - C. Falls within JEDEC MS-001 variation BA.

N (R-PDIP-T\*\*)

PLASTIC DUAL-IN-LINE PACKAGE

16 PINS SHOWN



- NOTES:
- A. All linear dimensions are in inches (millimeters).
  - B. This drawing is subject to change without notice.
  - Falls within JEDEC MS-001, except 18 and 20 pin minimum body length (Dim A).
  - The 20 pin end lead shoulder width is a vendor option, either half or full width.



DBV (R-PDSO-G5)

PLASTIC SMALL-OUTLINE PACKAGE



- NOTES:
- All linear dimensions are in millimeters.
  - This drawing is subject to change without notice.
  - Body dimensions do not include mold flash or protrusion. Mold flash and protrusion shall not exceed 0.15 per side.
  - Falls within JEDEC MO-178 Variation AA.

DBV (R-PDSO-G5)

PLASTIC SMALL OUTLINE



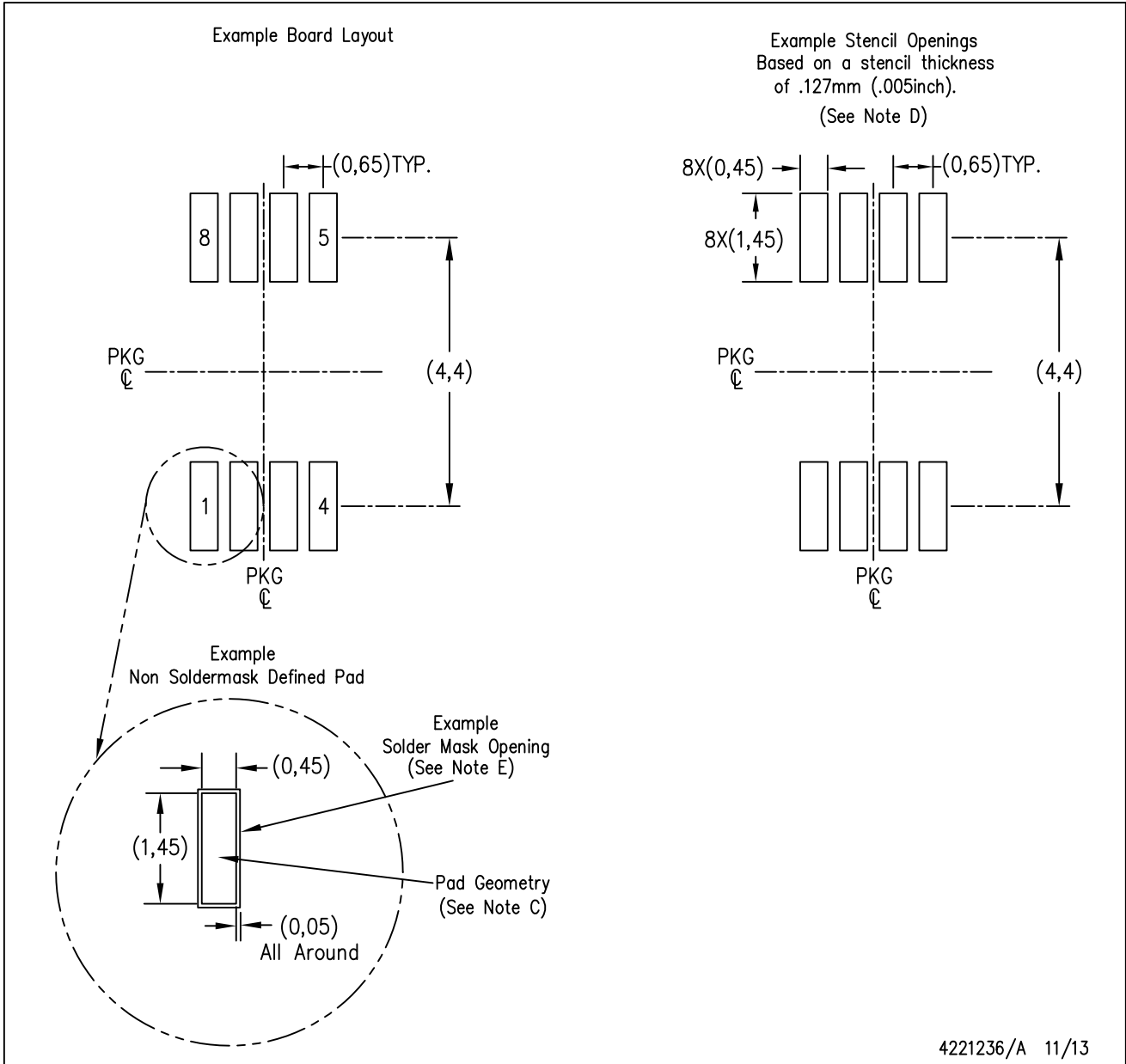
- NOTES:
- A. All linear dimensions are in millimeters.
  - B. This drawing is subject to change without notice.
  - C. Customers should place a note on the circuit board fabrication drawing not to alter the center solder mask defined pad.
  - D. Publication IPC-7351 is recommended for alternate designs.
  - E. Laser cutting apertures with trapezoidal walls and also rounding corners will offer better paste release. Customers should contact their board assembly site for stencil design recommendations. Example stencil design based on a 50% volumetric metal load solder paste. Refer to IPC-7525 for other stencil recommendations.

DGK (S-PDSO-G8)

PLASTIC SMALL-OUTLINE PACKAGE



- NOTES:
- A. All linear dimensions are in millimeters.
  - B. This drawing is subject to change without notice.
  - C. Body length does not include mold flash, protrusions, or gate burrs. Mold flash, protrusions, or gate burrs shall not exceed 0.15 per end.
  - D. Body width does not include interlead flash. Interlead flash shall not exceed 0.50 per side.
  - E. Falls within JEDEC MO-187 variation AA, except interlead flash.



- NOTES:
- A. All linear dimensions are in millimeters.
  - B. This drawing is subject to change without notice.
  - C. Publication IPC-7351 is recommended for alternate designs.
  - D. Laser cutting apertures with trapezoidal walls and also rounding corners will offer better paste release. Customers should contact their board assembly site for stencil design recommendations. Refer to IPC-7525 for other stencil recommendations.
  - E. Customers should contact their board fabrication site for solder mask tolerances between and around signal pads.

D (R-PDSO-G14)

PLASTIC SMALL OUTLINE



- NOTES:
- A. All linear dimensions are in inches (millimeters).
  - B. This drawing is subject to change without notice.
  -  Body length does not include mold flash, protrusions, or gate burrs. Mold flash, protrusions, or gate burrs shall not exceed 0.006 (0,15) each side.
  -  Body width does not include interlead flash. Interlead flash shall not exceed 0.017 (0,43) each side.
  - E. Reference JEDEC MS-012 variation AB.

D (R-PDSO-G14)

PLASTIC SMALL OUTLINE

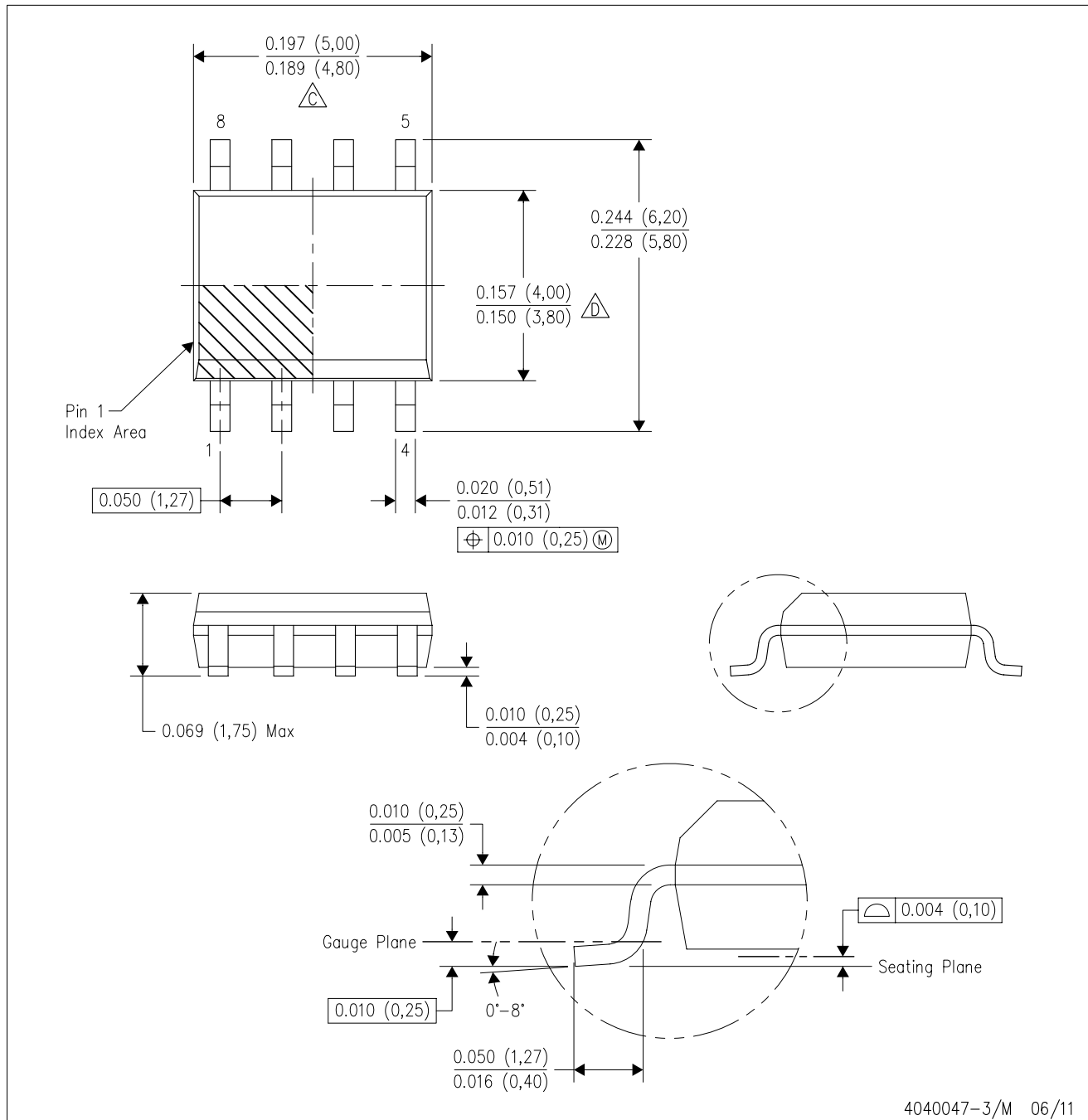


- NOTES:
- A. All linear dimensions are in millimeters.
  - B. This drawing is subject to change without notice.
  - C. Publication IPC-7351 is recommended for alternate designs.
  - D. Laser cutting apertures with trapezoidal walls and also rounding corners will offer better paste release. Customers should contact their board assembly site for stencil design recommendations. Refer to IPC-7525 for other stencil recommendations.
  - E. Customers should contact their board fabrication site for solder mask tolerances between and around signal pads.



D (R-PDSO-G8)

PLASTIC SMALL OUTLINE



4040047-3/M 06/11



D (R-PDSO-G8)

PLASTIC SMALL OUTLINE



- NOTES:
- A. All linear dimensions are in millimeters.
  - B. This drawing is subject to change without notice.
  - C. Publication IPC-7351 is recommended for alternate designs.
  - D. Laser cutting apertures with trapezoidal walls and also rounding corners will offer better paste release. Customers should contact their board assembly site for stencil design recommendations. Refer to IPC-7525 for other stencil recommendations.
  - E. Customers should contact their board fabrication site for solder mask tolerances between and around signal pads.

## IMPORTANT NOTICE

Texas Instruments Incorporated (TI) reserves the right to make corrections, enhancements, improvements and other changes to its semiconductor products and services per JESD46, latest issue, and to discontinue any product or service per JESD48, latest issue. Buyers should obtain the latest relevant information before placing orders and should verify that such information is current and complete.

TI's published terms of sale for semiconductor products (<http://www.ti.com/sc/docs/stdterms.htm>) apply to the sale of packaged integrated circuit products that TI has qualified and released to market. Additional terms may apply to the use or sale of other types of TI products and services.

Reproduction of significant portions of TI information in TI data sheets is permissible only if reproduction is without alteration and is accompanied by all associated warranties, conditions, limitations, and notices. TI is not responsible or liable for such reproduced documentation. Information of third parties may be subject to additional restrictions. Resale of TI products or services with statements different from or beyond the parameters stated by TI for that product or service voids all express and any implied warranties for the associated TI product or service and is an unfair and deceptive business practice. TI is not responsible or liable for any such statements.

Buyers and others who are developing systems that incorporate TI products (collectively, "Designers") understand and agree that Designers remain responsible for using their independent analysis, evaluation and judgment in designing their applications and that Designers have full and exclusive responsibility to assure the safety of Designers' applications and compliance of their applications (and of all TI products used in or for Designers' applications) with all applicable regulations, laws and other applicable requirements. Designer represents that, with respect to their applications, Designer has all the necessary expertise to create and implement safeguards that (1) anticipate dangerous consequences of failures, (2) monitor failures and their consequences, and (3) lessen the likelihood of failures that might cause harm and take appropriate actions. Designer agrees that prior to using or distributing any applications that include TI products, Designer will thoroughly test such applications and the functionality of such TI products as used in such applications.

TI's provision of technical, application or other design advice, quality characterization, reliability data or other services or information, including, but not limited to, reference designs and materials relating to evaluation modules, (collectively, "TI Resources") are intended to assist designers who are developing applications that incorporate TI products; by downloading, accessing or using TI Resources in any way, Designer (individually or, if Designer is acting on behalf of a company, Designer's company) agrees to use any particular TI Resource solely for this purpose and subject to the terms of this Notice.

TI's provision of TI Resources does not expand or otherwise alter TI's applicable published warranties or warranty disclaimers for TI products, and no additional obligations or liabilities arise from TI providing such TI Resources. TI reserves the right to make corrections, enhancements, improvements and other changes to its TI Resources. TI has not conducted any testing other than that specifically described in the published documentation for a particular TI Resource.

Designer is authorized to use, copy and modify any individual TI Resource only in connection with the development of applications that include the TI product(s) identified in such TI Resource. NO OTHER LICENSE, EXPRESS OR IMPLIED, BY ESTOPPEL OR OTHERWISE TO ANY OTHER TI INTELLECTUAL PROPERTY RIGHT, AND NO LICENSE TO ANY TECHNOLOGY OR INTELLECTUAL PROPERTY RIGHT OF TI OR ANY THIRD PARTY IS GRANTED HEREIN, including but not limited to any patent right, copyright, mask work right, or other intellectual property right relating to any combination, machine, or process in which TI products or services are used. Information regarding or referencing third-party products or services does not constitute a license to use such products or services, or a warranty or endorsement thereof. Use of TI Resources may require a license from a third party under the patents or other intellectual property of the third party, or a license from TI under the patents or other intellectual property of TI.

TI RESOURCES ARE PROVIDED "AS IS" AND WITH ALL FAULTS. TI DISCLAIMS ALL OTHER WARRANTIES OR REPRESENTATIONS, EXPRESS OR IMPLIED, REGARDING RESOURCES OR USE THEREOF, INCLUDING BUT NOT LIMITED TO ACCURACY OR COMPLETENESS, TITLE, ANY EPIDEMIC FAILURE WARRANTY AND ANY IMPLIED WARRANTIES OF MERCHANTABILITY, FITNESS FOR A PARTICULAR PURPOSE, AND NON-INFRINGEMENT OF ANY THIRD PARTY INTELLECTUAL PROPERTY RIGHTS. TI SHALL NOT BE LIABLE FOR AND SHALL NOT DEFEND OR INDEMNIFY DESIGNER AGAINST ANY CLAIM, INCLUDING BUT NOT LIMITED TO ANY INFRINGEMENT CLAIM THAT RELATES TO OR IS BASED ON ANY COMBINATION OF PRODUCTS EVEN IF DESCRIBED IN TI RESOURCES OR OTHERWISE. IN NO EVENT SHALL TI BE LIABLE FOR ANY ACTUAL, DIRECT, SPECIAL, COLLATERAL, INDIRECT, PUNITIVE, INCIDENTAL, CONSEQUENTIAL OR EXEMPLARY DAMAGES IN CONNECTION WITH OR ARISING OUT OF TI RESOURCES OR USE THEREOF, AND REGARDLESS OF WHETHER TI HAS BEEN ADVISED OF THE POSSIBILITY OF SUCH DAMAGES.

Unless TI has explicitly designated an individual product as meeting the requirements of a particular industry standard (e.g., ISO/TS 16949 and ISO 26262), TI is not responsible for any failure to meet such industry standard requirements.

Where TI specifically promotes products as facilitating functional safety or as compliant with industry functional safety standards, such products are intended to help enable customers to design and create their own applications that meet applicable functional safety standards and requirements. Using products in an application does not by itself establish any safety features in the application. Designers must ensure compliance with safety-related requirements and standards applicable to their applications. Designer may not use any TI products in life-critical medical equipment unless authorized officers of the parties have executed a special contract specifically governing such use. Life-critical medical equipment is medical equipment where failure of such equipment would cause serious bodily injury or death (e.g., life support, pacemakers, defibrillators, heart pumps, neurostimulators, and implantables). Such equipment includes, without limitation, all medical devices identified by the U.S. Food and Drug Administration as Class III devices and equivalent classifications outside the U.S.

TI may expressly designate certain products as completing a particular qualification (e.g., Q100, Military Grade, or Enhanced Product). Designers agree that it has the necessary expertise to select the product with the appropriate qualification designation for their applications and that proper product selection is at Designers' own risk. Designers are solely responsible for compliance with all legal and regulatory requirements in connection with such selection.

Designer will fully indemnify TI and its representatives against any damages, costs, losses, and/or liabilities arising out of Designer's non-compliance with the terms and provisions of this Notice.