



Micro Commercial Components



Micro Commercial Components
20736 Marilla Street Chatsworth
CA 91311
Phone: (818) 701-4933
Fax: (818) 701-4939

SK4200L

Features

- Halogen free available upon request by adding suffix "-HF"
Lead Free Finish/RoHS Compliant(Note 1) ("P" Suffix designates RoHS Compliant. See ordering information)
Epoxy meets UL 94 V-0 flammability rating
Moisture Sensitivity Level 1
For Surface Mount Applications
Easy Pick And Place
High Temp Soldering: 260°C for 10 Seconds At Terminals

Maximum Ratings

- Operating Temperature: -55°C to +150°C
Storage Temperature: -55°C to +150°C
Maximum Thermal Resistance; 11°C/W Junction To Lead

Table with 5 columns: MCC Catalog Number, Device Marking, Maximum Recurrent Peak Reverse Voltage, Maximum RMS Voltage, Maximum DC Blocking Voltage. Row 1: SK4200L, SK4200, 200V, 140V, 200V

Electrical Characteristics @ 25°C Unless Otherwise Specified

Table with 4 columns: Parameter, Symbol, Value, Conditions. Rows include Average Forward Current, Peak Forward Surge Current, Maximum Instantaneous Forward Voltage, Maximum DC Reverse Current At Rated DC Blocking Voltage, Maximum Reverse Recovery Time.

Notes: 1. High Temperature Solder Exemption Applied, see EU Directive Annex Notes 7.

4 Amp Schottky Rectifier
200 Volts

DO-214AB (SMC) (LEAD FRAME)

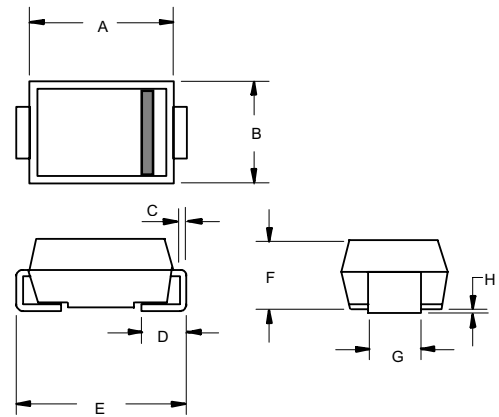
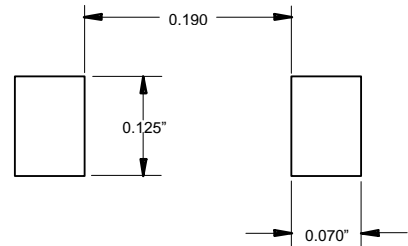
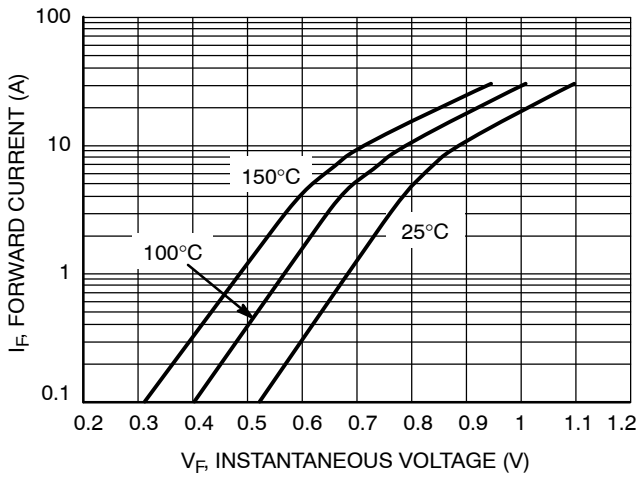


Table with 6 columns: DIM, INCHES (MIN, MAX), MM (MIN, MAX), NOTE. Dimensions A through H.

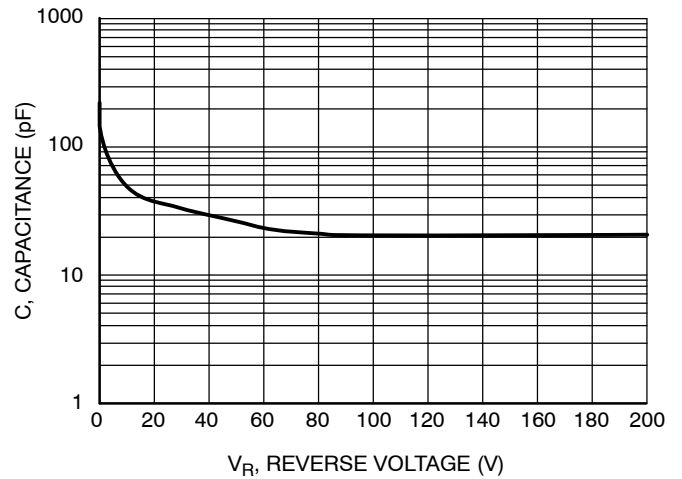
SUGGESTED SOLDER PAD LAYOUT



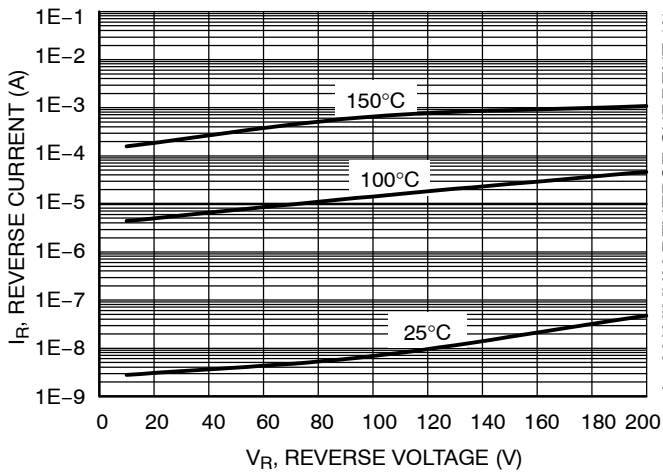
# SK4200L



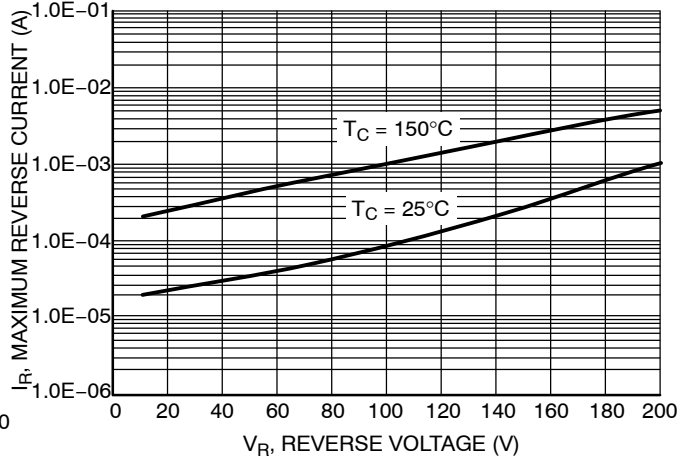
**Figure 1. Typical Forward Voltage**



**Figure 2. Typical Capacitance**

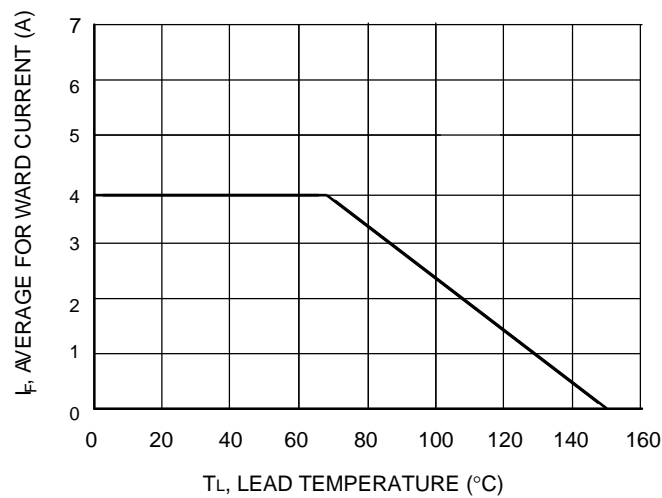


**Figure 3. Typical Reverse Current**



**Figure 4. Maximum Reverse Current**

# SK4200L



**Figure 5. Derating Curve**



Micro Commercial Components

### Ordering Information :

Device	Packing
Part Number-TP	Tape&Reel: 3Kpcs/Reel

Note : Adding "-HF" suffix for halogen free, eg. Part Number-TP-HF

#### \*\*\*IMPORTANT NOTICE\*\*\*

**Micro Commercial Components Corp.** reserves the right to make changes without further notice to any product herein to make corrections, modifications , enhancements , improvements , or other changes . **Micro Commercial Components Corp .** does not assume any liability arising out of the application or use of any product described herein; neither does it convey any license under its patent rights ,nor the rights of others . The user of products in such applications shall assume all risks of such use and will agree to hold **Micro Commercial Components Corp .** and all the companies whose products are represented on our website, harmless against all damages.

#### \*\*\*LIFE SUPPORT\*\*\*

MCC's products are not authorized for use as critical components in life support devices or systems without the express written approval of Micro Commercial Components Corporation.

#### \*\*\*CUSTOMER AWARENESS\*\*\*

Counterfeiting of semiconductor parts is a growing problem in the industry. Micro Commercial Components (MCC) is taking strong measures to protect ourselves and our customers from the proliferation of counterfeit parts. MCC strongly encourages customers to purchase MCC parts either directly from MCC or from Authorized MCC Distributors who are listed by country on our web page cited below. Products customers buy either from MCC directly or from Authorized MCC Distributors are genuine parts, have full traceability, meet MCC's quality standards for handling and storage. **MCC will not provide any warranty coverage or other assistance for parts bought from Unauthorized Sources.** MCC is committed to combat this global problem and encourage our customers to do their part in stopping this practice by buying direct or from authorized distributors.

[www.mccsemi.com](http://www.mccsemi.com)